

Cannon Trident Connector System

Neptune Circular Connectors

Neptune is a range of circular connectors specifically designed for harsh environment applications. They come with membrane wire seals that meet the requirements for IP67 and do not require blanking plugs for unused cavities. They will accept various combinations of signal (13 A) and power (30 A) contacts. The receptacle connectors feature stainless steel bayonet pins integrally molded into the bodies. The plug connectors are available with either high strength metal or corrosion resistant plastic coupling rings.

Applications

- Off Road Vehicles.
- Truck and Bus.
- Agricultural Equipment.
- Construction Equipment.
- Outdoor Electronics



Neptune
Circular

Product Features

- Mixes signal and 30 A power contacts in one housing.
- Printed circuit and coaxial contacts available.
- Full interface and cable sealing up to IP67.
- Large range support accessories.
- Robust, cost effective connector for harsh environments.

Performance Specifications

Temperature Range	-55°C to 105°C (-67°F to 221°F)
Test Voltage	2000 V ac rms
Working Voltage	25 V (Can be higher, if the equipment safety will allow)
Insulation Resistance	5000 MΩ at 500 V dc
Environmental Sealing	Up to IP67
Flammability	UL 94V-0

Materials and Finishes

Description	Material	Finish
Insulator	Black Nylon, UL 94V-0	None
Bayonet Pin	Stainless Steel	None
Bayonet Pin Support Band	High Strength Copper Alloy	Nickel
Coupling Ring	High Strength Copper Alloy	Nickel



Cannon Trident Connector System

Neptune Circular Connectors

Contact Cavity Arrangements

Neptune Circular Connectors offer combinations of signal and power contacts.

The Signal cavities will accept any of the standard Trident contacts, including signal contacts up to 13 A and coax. The power cavities will accept power contacts rated at 30 A. PCB contacts are also available, for more information see page 47.

Mating Face Views of Reversed and Standard Receptacles.

* The 0-12 view is of reversed receptacle only (0-12 standard receptacle is mirror image)

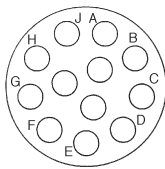

0-12*
Shell Size 14
12 Signal
0 Power

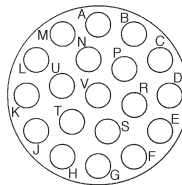

0-19
Shell Size 16
19 Signal
0 Power

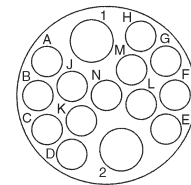

2-13
Shell Size 16
13 Signal
2 Power

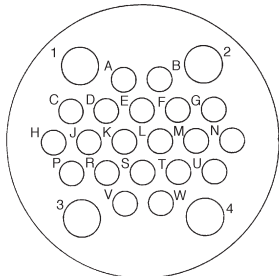

4-20
Shell Size 24
20 Signal
4 Power

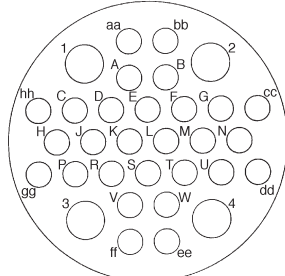

4-28
Shell Size 24
28 Signal
4 Power

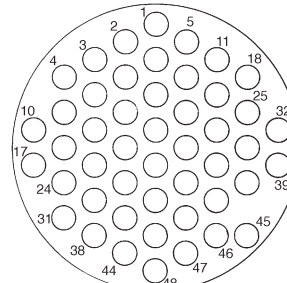

0-48
Shell Size 24
48 Signal
0 Power

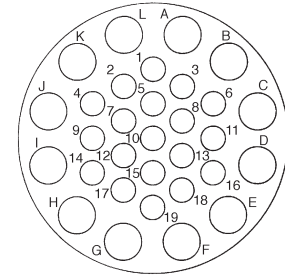

12-19
Shell Size 24
19 Signal
12 Power

Note: The shell size indicates the diameter of the interface in sixteenths of an inch.
Example: Shell Size 16 is 1.00 inch in diameter, 25,4 mm.

Wire Sealing Range

Contact Arrangement	Signal (Overall Diameter)	Power (Overall Diameter)
0-12	1,70-2,70 (.066-.106)	N/A
0-19	1,70-2,70 (.066-.106)	N/A
2-13	1,70-2,70 (.066-.106)	2,70-4,00 (.106-.157)
4-20	1,70-2,70 (.066-.106)	2,70-4,00 (.106-.157)
4-28	1,70-2,70 (.066-.106)	2,70-4,00 (.106-.157)
0-48	1,70-2,20 (.066-.086)	N/A
0-48 (L)	2,30-3,20 (.090-.126)	N/A
12-19	1,70-2,70 (.066-.106)	2,70-4,00 (.106-.157)

(L) Larger overall sealing diameter for thick insulation wires.

Cannon Trident Connector System

Neptune Circular Connectors

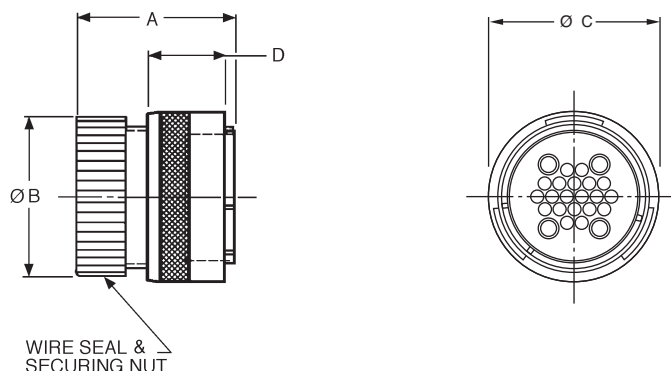

Standard Plugs — Pin Contacts Metal Locking Ring

- For Wire Sealing Ranges, see page 29.
- Accepts pin contacts, see page 47.
- Water sealed to IP67.
- Bulk packaging options available. Contact Cannon for details.

Contact Layout	Shell Size	Part Number	Nomenclature	A	ØB	ØC	D
4-20	24	192900-0014	TN 6S 2404-20 P1L	39,80 (1.566)	40,50 (1.594)	44,00 (1.732)	14,72 ±0,15 (.580 ±.006)
4-28	24	192900-0015	TN 6S 2404-28 P1L	39,80 (1.566)	40,50 (1.594)	44,00 (1.732)	14,72 ±0,15 (.580 ±.006)
12-19	24	192900-0016	TN 6S 2412-19 P1L	39,80 (1.566)	40,50 (1.594)	44,00 (1.732)	14,72 ±0,15 (.580 ±.006)
0-48	24	192900-0469	TN 6S 2400-48 P1L	39,80 (1.566)	40,50 (1.594)	44,00 (1.732)	14,72 ±0,15 (.580 ±.006)
0-48 (L)	24	192991-0628	TN 6L 2400-48 P1L	50,70 (2.000)	40,50 (1.594)	44,00 (1.732)	14,72 ±0,15 (.580 ±.006)
0-19	16	192900-0017	TN 6S 1600-19 P1L	39,80 (1.566)	27,00 (1.063)	30,20 (1.189)	19,10 ±0,20 (.751 ±.007)
2-13	16	192900-0507	TN 6S 1602-13 P1L	39,80 (1.566)	27,00 (1.063)	30,20 (1.189)	19,10 ±0,20 (.751 ±.007)
0-12	14	192900-0303	TN 6S 1400-12 P1L	38,80 (1.527)	24,30 (.957)	28,00 (1.102)	19,10 ±0,20 (.751 ±.007)

(L) Larger overall sealing diameter for thick insulation wires.

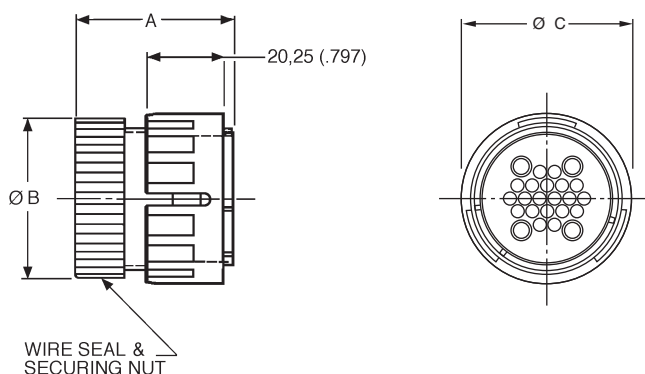

Plastic Locking Ring

- For Wire Sealing Ranges, see page 29.
- Accepts pin contacts, see page 47.
- Water sealed to IP67.
- Bulk packaging options available. Contact Cannon for details.

Contact Layout	Shell Size	Part Number	Nomenclature	A	ØB	ØC
4-20	24	192900-0537	TN 6S2404-20 P2L	39,80 (1.566)	40,50 (1.594)	45,75 (1.800)
4-28	24	192900-0549	TN 6S2404-28 P2L	39,80 (1.566)	40,50 (1.594)	45,75 (1.800)
12-19	24	192900-0538	TN 6S2412-19 P2L	39,80 (1.566)	40,50 (1.594)	45,75 (1.800)
0-48	24	192900-0539	TN 6S2400-48 P2L	39,80 (1.566)	40,50 (1.594)	45,75 (1.800)
0-48 (L)	24	192991-0660	TN 6L2400-48 P2L	50,70 (2.000)	40,50 (1.594)	45,75 (1.800)
0-19	16	192900-0557	TN 6S1600-19 P2L	39,80 (1.566)	27,00 (1.063)	32,80 (1.291)
2-13	16	192900-0561	TN 6S1602-13 P2L	39,80 (1.566)	27,00 (1.063)	32,80 (1.291)

(L) Larger overall sealing diameter for thick insulation wires.

Dimensions are shown in mm (inch)
Dimensions subject to change



Dimensions shown in mm (inch)
Specifications and dimensions subject to change

www.ittcannon.com

Cannon Trident Connector System

Neptune Circular Connectors

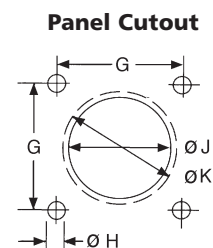
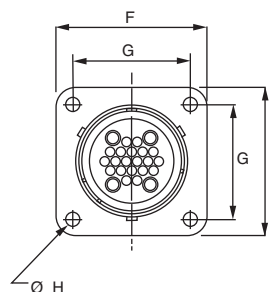
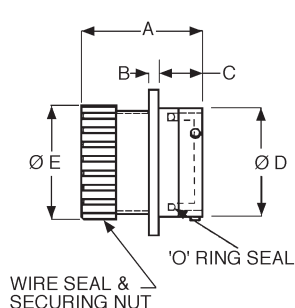

ØJ = Flange in Front of Panel
ØK = Flange at Rear of Panel

Standard Receptacles — Socket Contacts Flange Mounting

- For Wire Sealing Ranges, see page 29.
- For Panel Gaskets, see page 37.
- Receptacle may be ordered without securing nut and wire seal. Contact Cannon for details.
- Bulk packaging options available. Contact Cannon for details.

Contact Shell

Layout	Size	Part Number	Nomenclature	A	B	C	ØD	ØE	F	G	ØH	ØJ	ØK
4-20	24	192900-0030	TN OS 2404-20 S1L	41,80 (1.645)	3,50 (.137)	15,40 (.606)	38,10 (1.500)	40,10 (1.578)	50,80 (2.000)	39,70 (1.563)	4,20 (.165)	41,00 (1.614)	41,00 (1.614)
4-28	24	192900-0033	TN OS 2404-28 S1L	41,80 (1.645)	3,50 (.137)	15,40 (.606)	38,10 (1.500)	40,10 (1.578)	50,80 (2.000)	39,70 (1.563)	4,20 (.165)	41,00 (1.614)	41,00 (1.614)
12-19	24	192900-0036	TN OS 2412-19 S1L	41,80 (1.645)	3,50 (.137)	15,40 (.606)	38,10 (1.500)	40,10 (1.578)	50,80 (2.000)	39,70 (1.563)	4,20 (.165)	41,00 (1.614)	41,00 (1.614)
0-48	24	192900-0475	TN OS 2400-48 S1L	41,80 (1.645)	3,50 (.137)	15,40 (.606)	38,10 (1.500)	40,10 (1.578)	50,80 (2.000)	39,70 (1.563)	4,20 (.165)	41,00 (1.614)	41,00 (1.614)
0-48 (L)	24	192991-0640	TN OL 2400-48 S1L	52,70 (2.075)	3,50 (.137)	15,40 (.606)	38,10 (1.500)	40,10 (1.578)	50,80 (2.000)	39,70 (1.563)	4,20 (.165)	41,00 (1.614)	41,00 (1.614)
0-19	16	192900-0039	TN OS 1600-19 S1L	39,80 (1.566)	2,30 (.090)	11,40 (.448)	25,40 (1.000)	27,00 (1.063)	31,00 (1.220)	24,50 (.964)	3,20 (.125)	28,10 (1.106)	28,10 (1.106)
2-13	16	192900-0509	TN OS 1602-13 S1L	39,80 (1.566)	2,30 (.090)	11,40 (.448)	25,40 (1.000)	27,00 (1.063)	31,00 (1.220)	24,50 (.964)	3,20 (.125)	28,10 (1.106)	28,10 (1.106)
0-12	14	192900-0308	TN OS 1400-12 S1L	39,70 (1.563)	2,30 (.090)	11,40 (.448)	22,20 (.874)	24,30 (.956)	28,60 (1.122)	22,90 (.901)	3,20 (.125)	24,60 (.968)	24,60 (.968)

(L) Larger overall sealing diameter for thick insulation wires.

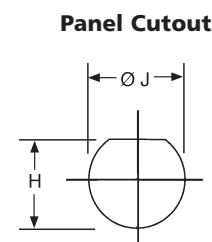
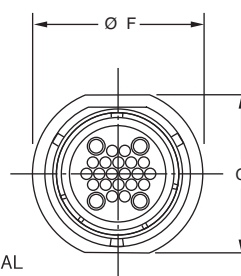
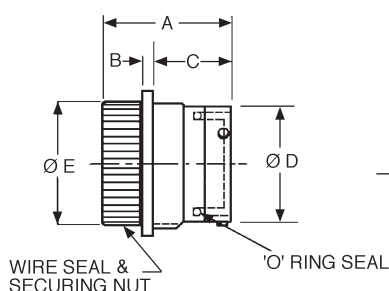

Jam Nut Mounting

- Jam Nut included.
- For Wire Sealing Ranges, see page 29.
- For Panel Gaskets, see page 35.
- Receptacle may be ordered without securing nut and wire seal. Contact Cannon for details.
- Bulk packaging options available. Contact Cannon for details.

Contact Shell

Layout	Size	Part Number	Nomenclature	A	B	C	ØD	ØE	ØF	G	H	ØJ
4-20	24	192900-0032	TN 7S 240420 S1L	41,80 (1.645)	3,50 (.137)	23,40 (.921)	38,10 (1.500)	40,10 (1.578)	51,00 (2.007)	47,50 (1.870)	41,50 (1.633)	43,20 (1.700)
4-28	24	192900-0035	TN 7S 240428 S1L	41,80 (1.645)	3,50 (.137)	23,40 (.921)	38,10 (1.500)	40,10 (1.578)	51,00 (2.007)	47,50 (1.870)	41,50 (1.633)	43,20 (1.700)
12-19	24	192900-0038	TN 7S 241219 S1L	41,80 (1.645)	3,50 (.137)	23,40 (.921)	38,10 (1.500)	40,10 (1.578)	51,00 (2.007)	47,50 (1.870)	41,50 (1.633)	43,20 (1.700)
0-48	24	192900-0481	TN 7S 240048 S1L	41,80 (1.645)	3,50 (.137)	23,40 (.921)	38,10 (1.500)	40,10 (1.578)	51,00 (2.007)	47,50 (1.870)	41,50 (1.633)	43,20 (1.700)
0-48 (L)	24	192991-0644	TN 7L 240048 S1L	52,70 (2.075)	3,50 (.137)	23,40 (.921)	38,10 (1.500)	40,10 (1.578)	51,00 (2.007)	47,50 (1.870)	41,50 (1.633)	43,20 (1.700)
0-19	16	192900-0490	TN 7S 160019 S1L	39,80 (1.566)	2,30 (.090)	23,00 (.905)	25,40 (1.000)	27,00 (1.063)	39,80 (1.566)	38,40 (1.511)	28,00 (1.102)	30,50 (1.200)
2-13	16	192900-0508	TN 7S 160213 S1L	39,80 (1.566)	2,30 (.090)	23,00 (.905)	25,40 (1.000)	27,00 (1.063)	39,80 (1.566)	38,40 (1.511)	28,00 (1.102)	30,50 (1.200)
0-12	14	192900-0313	TN 7S 140012 S1L	39,70 (1.563)	3,50 (.137)	22,10 (.870)	22,20 (.874)	24,30 (.956)	35,80 (1.409)	32,20 (1.267)	25,10 (.988)	27,30 (1.075)

(L) Larger overall sealing diameter for thick insulation wires.

Cannon Trident Connector System

Neptune Circular Connectors

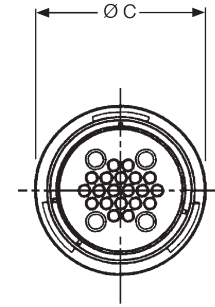
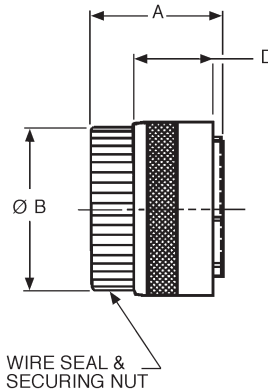

Reversed Plugs — Socket Contacts Metal Locking Ring

- For Wire Sealing Ranges, see page 29.
- Accepts socket contacts, see page 47.
- Water sealed to IP67.
- Bulk packaging options available. Contact Cannon for details.

Contact Layout	Shell Size	Part Number	Nomenclature	A	Ø B	Ø C	D
4-20	24	192900-0054	TN 6S 240420 S1L	32,40 (1.275)	40,50 (1.594)	44,00 (1.732)	14,72 ±0,15 (.580 ±.006)
4-28	24	192900-0055	TN 6S 240428 S1L	32,40 (1.275)	40,50 (1.594)	44,00 (1.732)	14,72 ±0,15 (.580 ±.006)
12-19	24	192900-0056	TN 6S 241219 S1L	32,40 (1.275)	40,50 (1.594)	44,00 (1.732)	14,72 ±0,15 (.580 ±.006)
0-48	24	192900-0425	TN 6S 240048 S1L	32,40 (1.275)	40,50 (1.594)	44,00 (1.732)	14,72 ±0,15 (.580 ±.006)
0-48 (L)	24	192991-0648	TN 6SL 240048 S1L	43,00 (1.693)	40,50 (1.594)	44,00 (1.732)	14,72 ±0,15 (.580 ±.006)
0-19	16	192900-0057	TN 6S 160019 S1L	31,70 (1.248)	27,00 (1.063)	30,20 (1.189)	19,10 ±0,20 (.751 ±.007)
2-13	16	192900-0581	TN 6S 160213 S1L	31,70 (1.248)	27,00 (1.063)	30,20 (1.189)	19,10 ±0,20 (.751 ±.007)
0-12	14	192900-0236	TN 6S 140012 S1L	31,60 (1.244)	24,30 (.957)	28,00 (1.102)	19,10 ±0,20 (.751 ±.007)

(L) Larger overall sealing diameter for thick insulation wires.

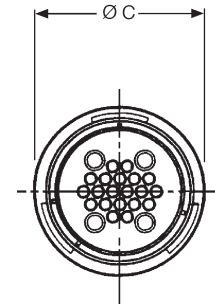
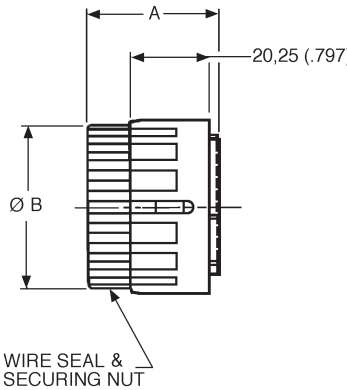

Plastic Locking Ring

- For Wire Sealing Ranges, see page 29.
- Accepts socket contacts, see page 47.
- Water sealed to IP67.
- Bulk packaging options available. Contact Cannon for details.

Contact Layout	Shell Size	Part Number	Nomenclature	A	Ø B	Ø C
4-20	24	192900-0540	TN 6S 2404-20S 2L	32,40 (1.275)	40,50 (1.594)	44,00 (1.732)
4-28	24	192900-0550	TN 6S 2404-28S 2L	32,40 (1.275)	40,50 (1.594)	44,00 (1.732)
12-19	24	192900-0541	TN 6S 2412-19S 2L	32,40 (1.275)	40,50 (1.594)	44,00 (1.732)
0-48	24	192900-0542	TN 6S 2400-48S 2L	32,40 (1.275)	40,50 (1.594)	44,00 (1.732)
0-48 (L)	24	192991-0664	TN 6L 2400-48S 2L	43,00 (1.693)	40,50 (1.594)	44,00 (1.732)
0-19	16	192900-0558	TN 6S 1600-19S 2L	31,70 (1.248)	27,00 (1.063)	32,80 (1.291)
2-13	16	192900-0562	TN 6S 1602-13S 2L	31,70 (1.248)	27,00 (1.063)	32,80 (1.291)

(L) Larger overall sealing diameter for thick insulation wires.



Dimensions shown in mm (inch)
Specifications and dimensions subject to change

www.ittcannon.com

Cannon Trident Connector System

Neptune Circular Connectors



Reversed Receptacles — Pin Contacts Flange Mounting

- For Wire Sealing Ranges, see page 29.
- For Panel Gaskets, see page 37.
- Receptacle may be ordered without securing nut and wire seal. Contact Cannon for details.
- Bulk packaging options available. Contact Cannon for details.

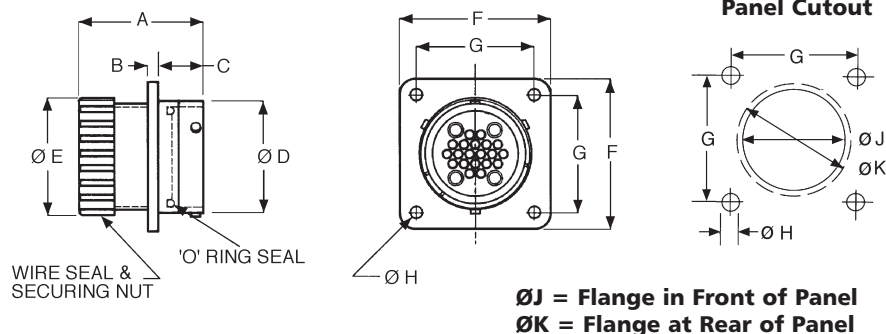

Contact Shell

Layout	Size	Part Number	Nomenclature	A	B	C	Ø D	Ø E	F	G	Ø H	Ø J	Ø K
4-20	24	192900-0069	TN OS 2404-20 P1L	41,80 (1.645)	3,50 (.137)	15,40 (.606)	38,10 (1.500)	40,10 (1.578)	50,80 (2.000)	39,70 (1.563)	4,20 (.165)	41,00 (1.614)	41,00 (1.614)
4-28	24	192900-0072	TN OS 2404-28 P1L	41,80 (1.645)	3,50 (.137)	15,40 (.606)	38,10 (1.500)	40,10 (1.578)	50,80 (2.000)	39,70 (1.563)	4,20 (.165)	41,00 (1.614)	41,00 (1.614)
12-19	24	192900-0075	TN SO 2412-19 P1L	41,80 (1.645)	3,50 (.137)	15,40 (.606)	38,10 (1.500)	40,10 (1.578)	50,80 (2.000)	39,70 (1.563)	4,20 (.165)	41,00 (1.614)	41,00 (1.614)
0-48	24	192900-0431	TN OS 2400-48 P1L	41,80 (1.645)	3,50 (.137)	15,40 (.606)	38,10 (1.500)	40,10 (1.578)	50,80 (2.000)	39,70 (1.563)	4,20 (.165)	41,00 (1.614)	41,00 (1.614)
0-48 (L)	24	192991-0652	TN OL 2400-48 P1L	52,70 (2.075)	3,50 (.137)	15,40 (.606)	38,10 (1.500)	40,10 (1.578)	50,80 (2.000)	39,70 (1.563)	4,20 (.165)	41,00 (1.614)	41,00 (1.614)
0-19	16	192900-0078	TN OS 1600-19 P1L	39,80 (1.566)	2,30 (.090)	11,40 (.448)	25,40 (1.000)	27,00 (1.063)	31,00 (1.220)	24,50 (.964)	3,20 (.125)	28,10 (1.106)	28,10 (1.106)
2-13	16	192900-0582	TN OS 1602-13 P1L	39,80 (1.566)	2,30 (.090)	11,40 (.448)	25,40 (1.000)	27,00 (1.063)	31,00 (1.220)	24,50 (.964)	3,20 (.125)	28,10 (1.106)	28,10 (1.106)
0-12	14	192900-0256	TN OS 1400-12 P1L	39,70 (1.563)	2,30 (.090)	11,40 (.448)	22,20 (.874)	24,30 (.956)	28,60 (1.122)	22,90 (.901)	3,20 (.125)	24,60 (.968)	24,60 (.968)

(L) Larger overall sealing diameter for thick insulation wires.



Jam Nut Mounting

- Jam Nut included.
- For Wire Sealing Ranges, see page 29.
- For Panel Gaskets, see page 37.
- Receptacle may be ordered without securing nut and wire seal. Contact Cannon for details.
- Bulk packaging options available. Contact Cannon for details.

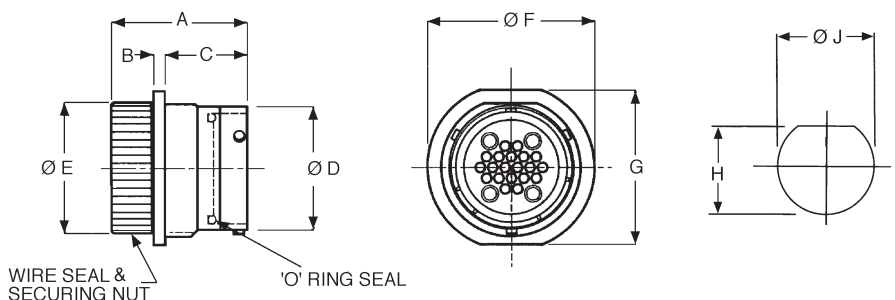

Neptune Circular

Contact Shell

Layout	Size	Part Number	Nomenclature	A	B	C	Ø D	Ø E	Ø F	G	H	Ø J
4-20	24	192900-0071	TN 7S 240420 P1L	41,80 (1.645)	3,50 (.137)	23,40 (.921)	38,10 (1.500)	40,10 (1.578)	51,00 (2.007)	47,50 (1.870)	41,50 (1.633)	43,20 (1.700)
4-28	24	192900-0074	TN 7S 240428 P1L	41,80 (1.645)	3,50 (.137)	23,40 (.921)	38,10 (1.500)	40,10 (1.578)	51,00 (2.007)	47,50 (1.870)	41,50 (1.633)	43,20 (1.700)
12-19	24	192900-0077	TN 7S 241219 P1L	41,80 (1.645)	3,50 (.137)	23,40 (.921)	38,10 (1.500)	40,10 (1.578)	51,00 (2.007)	47,50 (1.870)	41,50 (1.633)	43,20 (1.700)
0-48	24	192900-0437	TN 7S 240048 P1L	41,80 (1.645)	3,50 (.137)	23,40 (.921)	38,10 (1.500)	40,10 (1.578)	51,00 (2.007)	47,50 (1.870)	41,50 (1.633)	43,20 (1.700)
0-48 (L)	24	192991-0656	TN 7L 240048 P1L	52,70 (2.075)	3,50 (.137)	23,40 (.921)	38,10 (1.500)	40,10 (1.578)	51,00 (2.007)	47,50 (1.870)	41,50 (1.633)	43,20 (1.700)
0-19	16	192900-0353	TN 7S 160019 P1L	39,80 (1.566)	2,30 (.090)	23,00 (.905)	25,40 (1.000)	27,00 (1.063)	30,80 (1.212)	38,20 (1.503)	28,00 (1.102)	30,50 (1.200)
2-13	16	192900-0583	TN 7S 160213 P1L	39,80 (1.566)	2,30 (.090)	23,00 (.905)	25,40 (1.000)	27,00 (1.063)	30,80 (1.212)	38,20 (1.503)	28,00 (1.102)	30,50 (1.200)
0-12	14	192900-0266	TN 7S 140012 P1L	39,70 (1.563)	3,50 (.137)	22,10 (.870)	22,20 (.874)	24,30 (.956)	35,80 (1.409)	32,20 (1.267)	25,10 (.988)	27,30 (1.075)

(L) Larger overall sealing diameter for thick insulation wires.

Cannon Trident Connector System

Neptune Circular Connectors

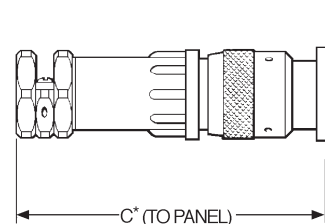
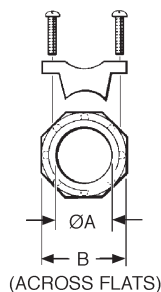

* For disassembly, add 9,00 (.354) for shell sizes 14 and 16 and add 10,60 (.417) for shell size 24.

Sealed Cable Clamps For Use With Neptune Circular Connectors

- For use with jacketed cables.
- Provides Strain relief and wire protection.
- Provides sealing to IP67.
- For assembly instructions, see page 57.

Shell Size	Part Number	Nomenclature	ØA max.	B	C max.	Wire Sealing Diameter	
						Minimum	Maximum
14	192900-0496	TNA 14 CCHC-00L	14,60 (.574)	22,80 (.897)	85,50 (3.366)	6,50 (.256)	12,40 (.488)
16	192900-0497	TNA 16 CCHC-00L	16,60 (.653)	24,70 (.972)	89,80 (3.535)	6,50 (.256)	12,40 (.488)
24	192900-0498	TNA 24 CCHC-00L	29,60 (1.165)	41,80 (1.645)	128,50 (5.059)	17,00 (.670)	26,50 (1.040)

* Assumes a uniformly cylindrical cable. Variations in the diameter could effect sealing.

Neptune Circular

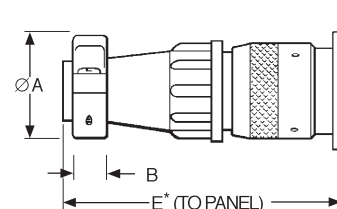
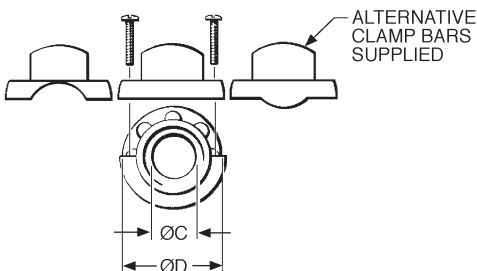

* For disassembly, add 9,00 (.354) for shell sizes 14 and 16 and add 10,60 (.417) for shell size 24.

Unsealed Cable Clamps For Use With Neptune Circular Connectors

- Provides strain relief and wire protection.
- For use with discrete wires or jacketed cables.
- For assembly instructions, see page 59.

Shell Size	Part Number	Nomenclature	ØA max.	B	ØC max.	ØD	E max.
16	192900-0343	TNA 16 CCSR-00L	30,10 (1.185)	6,40 (.251)	17,00 (.669)	30,20 (1.189)	67,10 (2.641)
24	192900-0344	TNA 24 CCSR-00L	41,80 (1.645)	8,20 (.322)	28,00 (1.102)	42,50 (1.673)	90,80 (3.574)



Dimensions shown in mm (inch)
Specifications and dimensions subject to change

www.ittcannon.com

Cannon Trident Connector System

Neptune Circular Connectors



Adapters

Type 1

Adapters facilitate the fitting of various accessories to the Neptune housings.

- External threads for use with conduit.

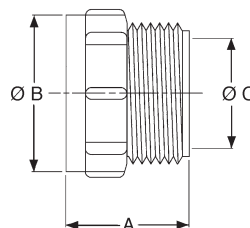

Shell Size	Part Number	Nomenclature	A	ØB	ØC
24	192900-0184	TNA 24 CA01-20L	52,80 (2.078)	40,50 (1.594)	31,80 (1.252)
24	192900-0185	TNA 24 CA01-25L	39,00 (1.535)	40,50 (1.594)	41,00 (1.614)
16	192900-0187	TNA 16 CA01-20L	35,00 (1.378)	28,00 (1.102)	31,80 (1.252)



Type 2

Adapters facilitate the fitting of various accessories to the Neptune housings.

- External grooves for heat shrink tubing or conduit "push-fit" onto the adapter.
- Standard type is recommended for sealed connections to the adapter.
- Drain hole type is recommended for non sealed connections. E.g. split conduit.

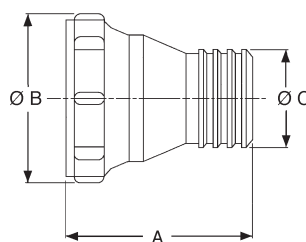

Standard Type

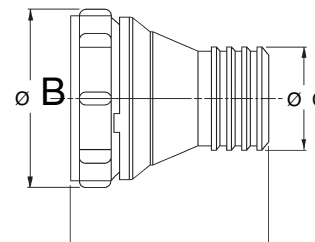

Drain Hole Type

Shell Size	Figure	Part Number	Nomenclature	A	ØB	ØC
24	1	192991-0013	TNA 24 CA02-26L	48,20 (1.897)	43,40 (1.708)	24,00 (.945)
24	2	192900-0654	TNA 24 CA22-26L	48,20 (1.897)	43,40 (1.708)	24,00 (.945)
16	1	192991-0015	TNA 16 CA02-18L	37,80 (1.488)	27,50 (1.082)	17,40 (.685)
16	2	192900-0674	TNA 16 CA22-18L	37,80 (1.488)	29,0 (1.14)	17,40 (.685)



Type 3

Adapters facilitate the fitting of various accessories to the Neptune housings.

- For use with a 90° elbow.
- External threads for use with conduit.

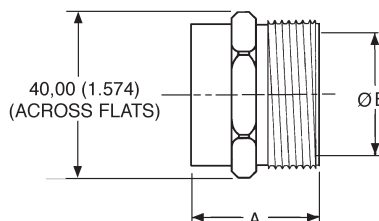

Shell Size	Part Number	Nomenclature	A	ØB
24	192900-0226	TNA 24 CA03-34L	36,50 (1.437)	34,70 (1.366)

Cannon Trident Connector System

Neptune Circular Connectors



Blanking Plugs

- Blanking plugs are used to repair damaged seals. If the membrane seal is pierced in a position that is not normally used, then the blanking plug will restore the seal.

Note: Replacement membrane seals are also available. Contact ITT for details.

Blanking Plugs for Signal Cavities

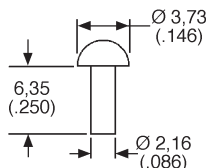

**Part Number
(Pack of 1000)**
192991-0018

Blanking Plugs for Power Cavities

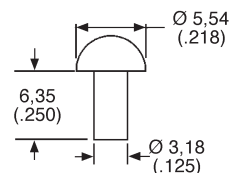

**Part Number
(Pack of 1000)**
192991-0019



Discriminating (Keying) Pins

- Discriminating (keying) pins are used to prevent cross-mating of similar connectors. These pins are used in place of a pin contact. The corresponding socket cavity must be left open. If a socket contact is present the discriminating pin will prevent mating.
- The discriminating pin is installed from the mating side of the connector.

Discriminating Pin Insertion

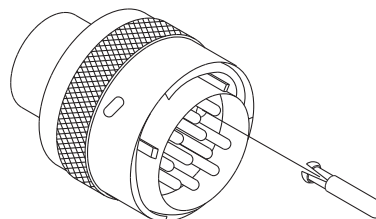

Prevents Cross - Mating

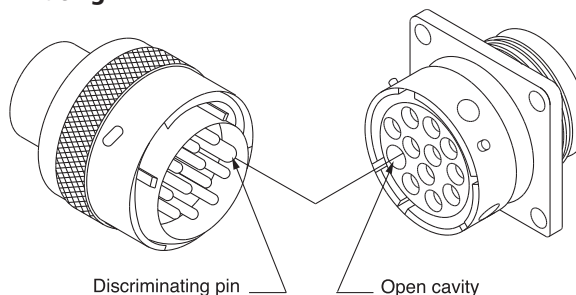

Discriminating pin Open cavity

Pin Type	Part Number (Pack of 25)
Signal	192990-0000
Power	192900-0189



Spare Jam Nuts

- Jam nut receptacles are packaged with the jam nut included.

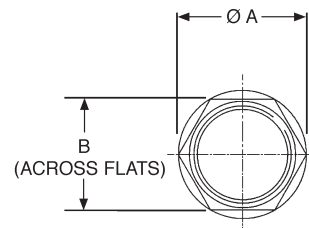
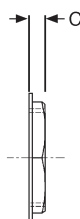

Shell Size	Part Number (Pack of 100)	ØA max.	B Nom	C
14	192900-0489	36,00 (1.417)	31,00 (1.220)	6,00 (.236)
16	192900-0488	40,60 (1.598)	35,00 (1.378)	6,00 (.236)
24	192900-0487	56,80 (2.236)	49,00 (1.929)	7,00 (.275)



Dimensions shown in mm (inch)
Specifications and dimensions subject to change

www.ittcannon.com

Cannon Trident Connector System

Neptune Circular Connectors



Plug Dust Cap

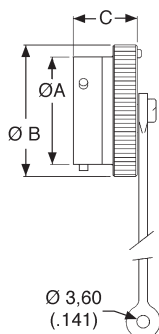

Receptacle Dust Cap

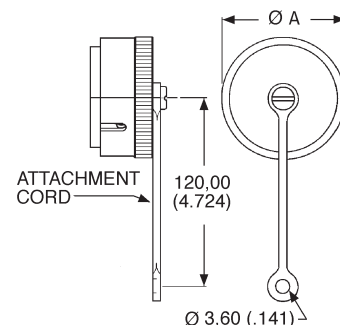

Dust Caps

Plastic Dust Caps are available for both plugs and receptacles. It is immaterial whether these are standard or reversed types, only the shell size matters in determining the correct item.

Shell Size	Part Number (Pack of 100)	ØA	ØB	C
16	192900-0388	25,40 (1.000)	31,70 (1.248)	14,30 (.562)
24	192900-0392	38,10 (1.500)	44,40 (1.748)	16,70 (.657)

Shell Size	Part Number (Pack of 100)	ØA
14	192900-0678	28,60 (1.126)
16	192900-0679	31,70 (1.248)
24	192900-0683	44,40 (1.748)

Flange Type

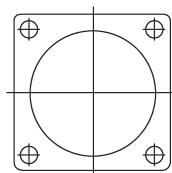

Jam Nut type

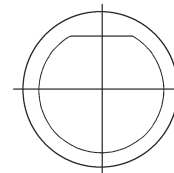

Panel Gaskets

- All panel gaskets are 1,50 (.059) thick.
- Bulk packaged. Sold in packs of 100.

Shell Size	Part Number (Pack of 100)
14	192900-0565
16	192900-0566
24	192900-0687

Shell Size	Part Number (Pack of 100)
14	192900-0457
16	192900-0402
24	192900-0458

Neptune
Circular