

Kingbright

T-1 3/4(5mm) BLINKING LED LAMP

Part Number: WP56BGD

Green

Features

- T-1 3/4 PACKAGE.
- WITH BUILT BLINKING IC.
- OPERATION VOLTAGE FROM 3.5V TO 14V.
- BLINKING FREQUENCY FROM 3.0Hz TO 1.5Hz.
- RoHs COMPLIANT.

Description

The Green source color devices are made with Gallium Phosphide Green Light Emitting Diode.

Package Dimensions

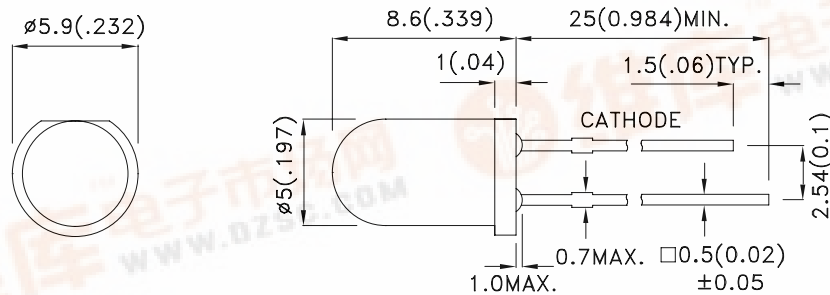

Notes:

1. All Dimensions are millimeters (inches).
2. Tolerance is $\pm 0.25 (0.01)$ unless otherwise noted.
3. Lead spacing is measured where the leads emerge from the package.
4. Specifications are subject to change without notice.



Kingbright

Selection Guide

Part No.	Dice	Lens Type	Iv (mcd) V= 9V		Viewing Angle [1]
			Min.	Typ.	2θ1/2
WP56BGD	Green (GaP)	GREEN DIFFUSED	5	20	60°

Note:

1. θ1/2 is the angle from optical centerline where the luminous intensity is 1/2 the optical centerline value.

Electrical / Optical Characteristics at TA=25°C

Symbol	Parameter	Device	Min.	Typ.	Max.	Units	Test Conditions
λ_{peak}	Peak Wavelength	Green		565		nm	
λ_D	Dominant Wavelength	Green		568		nm	
$\Delta\lambda_{1/2}$	Spectral Line Half-width	Green		30		nm	
I _F	Forward Current	Green	8	22		mA	Min:V _F =3.5V Typ:V _F =5V
I _{SON}	Supply Current	Green		8		mA	V _F =3.5V
I _{SON}	Supply Current	Green		44		mA	V _F =14V
f	Blink Frequency	Green	1.5		3	Hz	V _F =3.5V~14V

Absolute Maximum Ratings at TA=25°C

Parameter	Green	Units
Power dissipation	310	mW
Forward Voltage	14	V
Reverse Voltage	0.5	V
Operating Temperature	-40°C To +70°C	
Storage Temperature	-40°C To +85°C	
Lead Solder Temperature [1]	260°C For 3 Seconds	
Lead Solder Temperature [2]	260°C For 5 Seconds	

Notes:

- 2mm below package base.
- 5mm below package base.

Kingbright

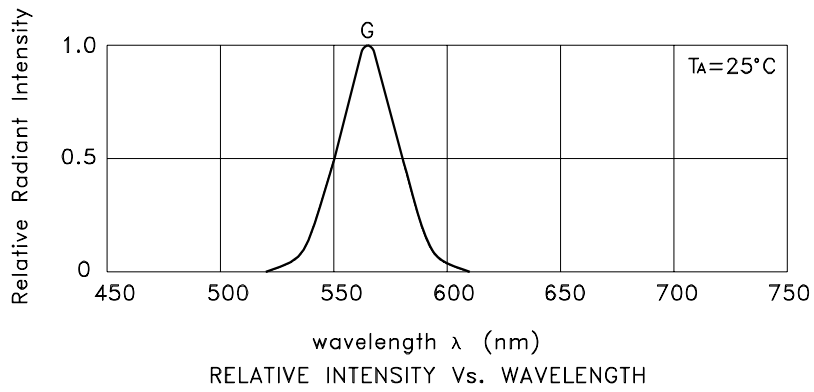

Green

WP56BGD

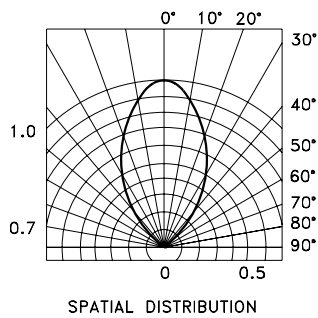
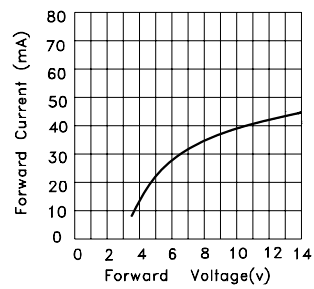
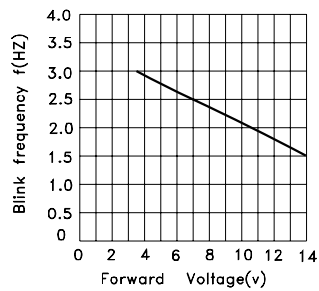

Kingbright

PACKING & LABEL SPECIFICATIONS

WP56BGD

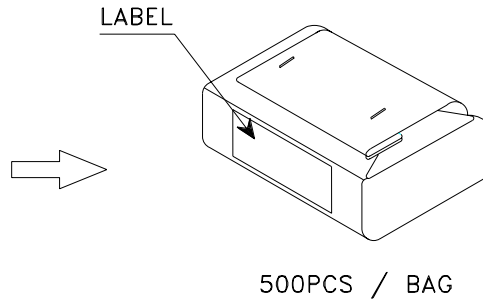
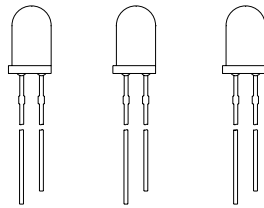

OUTSIDE LABEL

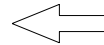

OUTSIDE LABEL

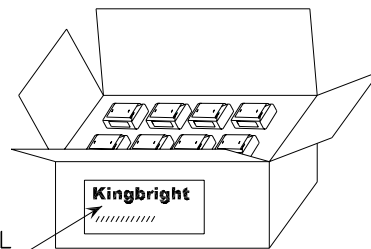

32K / 9# BOX

16K / 5# BOX

<h1>Kingbright</h1>				
Q.C.	<table border="1"> <tr> <td>QC</td> </tr> <tr> <td>XX XX XX</td> </tr> <tr> <td>PASSED</td> </tr> </table>	QC	XX XX XX	PASSED
QC				
XX XX XX				
PASSED				
TYPE NO :	WP56Bxxx			
QUANTITY :	500 pcs			
S/N :	XX			
CODE:	XX			
LOT NO :	 xxxxxxxxxxxx			
RoHS Compliant				

Kingbright

LED MOUNTING METHOD

1. The lead pitch of the LED must match the pitch of the mounting holes on the PCB during component placement. Lead-forming may be required to insure the lead pitch matches the hole pitch. Refer to the figure below for proper lead forming procedures.

(Fig. 1)

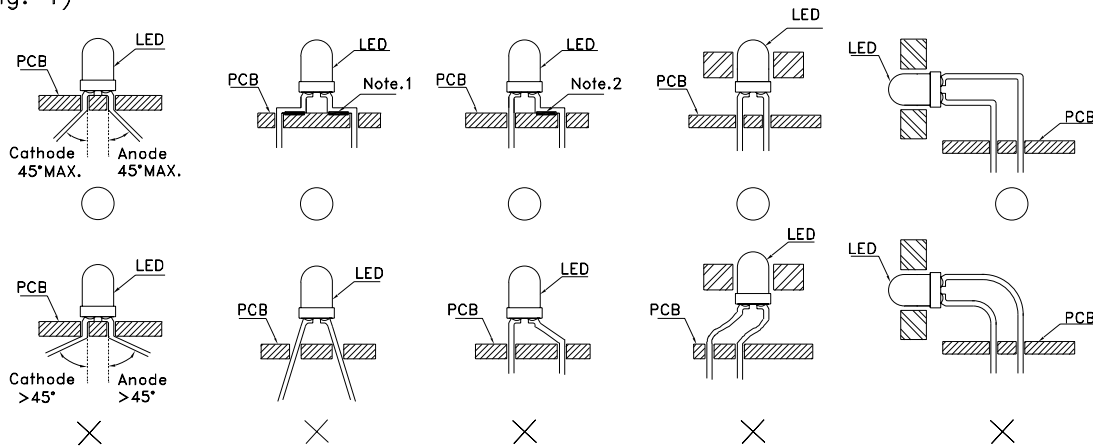

Fig.1

”○” Correct mounting method ”×” Incorrect mounting method

Note 1-2 : Do not route PCB trace in the contact area between the leadframe and the PCB to prevent short-circuits.

2. When soldering wire to the LED, use individual heat-shrink tubing to insulate the exposed leads to prevent accidental contact short-circuit.

(Fig. 2)

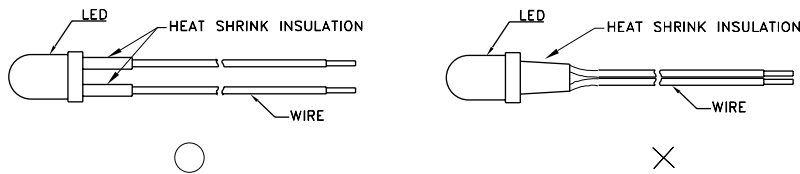

Fig. 2

3. Use stand-offs (Fig. 3) or spacers (Fig. 4) to securely position the LED above the PCB.

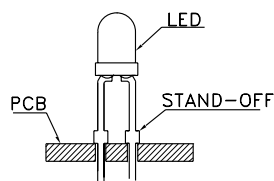

Fig. 3

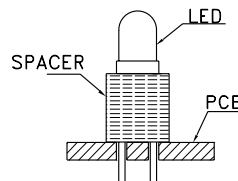

Fig. 4

LEAD FORMING PROCEDURES

1. Maintain a minimum of 2mm clearance between the base of the LED lens and the first lead bend. (Fig. 5 and 6)

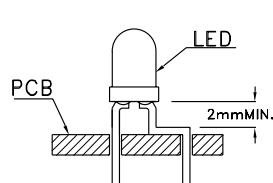

Fig. 5

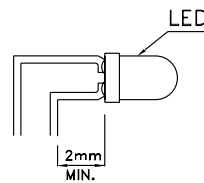

Fig. 6

2. Lead forming or bending must be performed before soldering, never during or after Soldering.
3. Do not stress the LED lens during lead-forming in order to fractures in the lens epoxy and damage the internal structures.
4. During lead forming, use tools or jigs to hold the leads securely so that the bending force will not be transmitted to the LED lens and its internal structures. Do not perform lead forming once the component has been mounted onto the PCB. (Fig. 7)
5. Do not bend the leads more than twice. (Fig. 8)

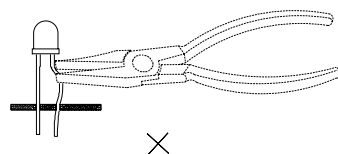

Fig. 7

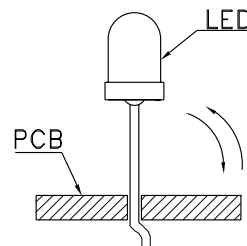

Fig. 8

6. After soldering or other high-temperature assembly, allow the LED to cool down to 50°C before applying outside force (Fig. 9). In general, avoid placing excess force on the LED to avoid damage. For any questions please consult with Kingbright representative for proper handling procedures.

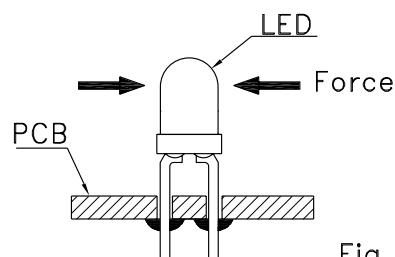

Fig. 9