

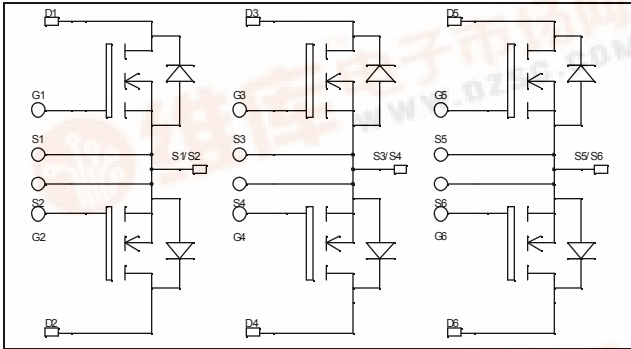

APT50TDUM65PG

**Triple dual common source
MOSFET Power Module**

**$V_{DSS} = 500V$
 $R_{DSon} = 65m\Omega$ typ @ $T_j = 25^\circ C$
 $I_D = 51A$ @ $T_c = 25^\circ C$**



Application

- AC Switches
- Switched Mode Power Supplies
- Uninterruptible Power Supplies

Features

- Power MOS 7[®] MOSFETs
 - Low R_{DSon}
 - Low input and Miller capacitance
 - Low gate charge
 - Avalanche energy rated
 - Very rugged
- Kelvin source for easy drive
- Very low stray inductance
 - Symmetrical design
 - Lead frames for power connections
- High level of integration

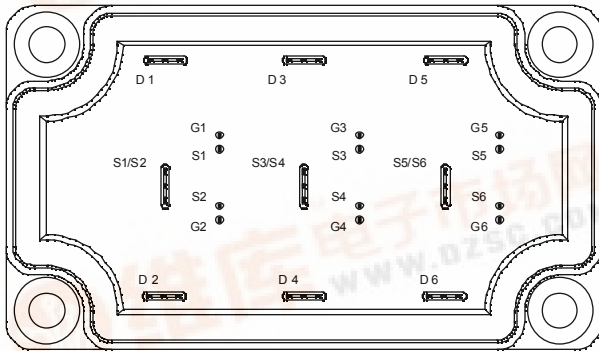

Benefits

- Outstanding performance at high frequency operation
- Direct mounting to heatsink (isolated package)
- Low junction to case thermal resistance
- Solderable terminals both for power and signal for easy PCB mounting
- Very low (12mm) profile
- Each leg can be easily paralleled to achieve a dual common source configuration of three times the current capability
- RoHS Compliant

Absolute maximum ratings

Symbol	Parameter	Max ratings	Unit
V_{DSS}	Drain - Source Breakdown Voltage	500	V
I_D	Continuous Drain Current	$T_c = 25^\circ C$	51
		$T_c = 80^\circ C$	38
I_{DM}	Pulsed Drain current	204	
V_{GS}	Gate - Source Voltage	± 30	V
R_{DSon}	Drain - Source ON Resistance	78	m Ω
P_D	Maximum Power Dissipation	$T_c = 25^\circ C$	390
I_{AR}	Avalanche current (repetitive and non repetitive)	51	A
E_{AR}	Repetitive Avalanche Energy	50	mJ
E_{AS}	Single Pulse Avalanche Energy	3000	

CAUTION: These Devices are sensitive to Electrostatic Discharge. Proper Handling Procedures Should Be Followed. See application note APT0502 on www.microsemi.com



All ratings @ $T_j = 25^\circ\text{C}$ unless otherwise specified

Electrical Characteristics

Symbol	Characteristic	Test Conditions	Min	Typ	Max	Unit
I_{DSS}	Zero Gate Voltage Drain Current	$V_{GS} = 0\text{V}, V_{DS} = 500\text{V}$			100	μA
		$V_{GS} = 0\text{V}, V_{DS} = 400\text{V}$	$T_j = 25^\circ\text{C}$		500	
$R_{DS(on)}$	Drain – Source on Resistance	$V_{GS} = 10\text{V}, I_D = 25.5\text{A}$		65	78	$\text{m}\Omega$
$V_{GS(th)}$	Gate Threshold Voltage	$V_{GS} = V_{DS}, I_D = 2.5\text{mA}$	3		5	V
I_{GSS}	Gate – Source Leakage Current	$V_{GS} = \pm 30\text{V}, V_{DS} = 0\text{V}$			± 100	nA

Dynamic Characteristics

Symbol	Characteristic	Test Conditions	Min	Typ	Max	Unit
C_{iss}	Input Capacitance	$V_{GS} = 0\text{V}$		7000		pF
C_{oss}	Output Capacitance	$V_{DS} = 25\text{V}$		1400		
C_{rss}	Reverse Transfer Capacitance	$f = 1\text{MHz}$		90		
Q_g	Total gate Charge	$V_{GS} = 10\text{V}$		140		nC
Q_{gs}	Gate – Source Charge	$V_{Bus} = 250\text{V}$		40		
Q_{gd}	Gate – Drain Charge	$I_D = 51\text{A}$		70		
$T_{d(on)}$	Turn-on Delay Time	Inductive switching @ 125°C $V_{GS} = 15\text{V}$ $V_{Bus} = 333\text{V}$ $I_D = 51\text{A}$ $R_G = 3\Omega$		21		ns
T_r	Rise Time			38		
$T_{d(off)}$	Turn-off Delay Time			75		
T_f	Fall Time			93		
E_{on}	Turn-on Switching Energy	Inductive switching @ 25°C $V_{GS} = 15\text{V}, V_{Bus} = 333\text{V}$ $I_D = 51\text{A}, R_G = 3\Omega$		1035		μJ
E_{off}	Turn-off Switching Energy			845		
E_{on}	Turn-on Switching Energy	Inductive switching @ 125°C $V_{GS} = 15\text{V}, V_{Bus} = 333\text{V}$ $I_D = 51\text{A}, R_G = 3\Omega$		1556		μJ
E_{off}	Turn-off Switching Energy			1013		

Source - Drain diode ratings and characteristics

Symbol	Characteristic	Test Conditions	Min	Typ	Max	Unit
I_S	Continuous Source current (Body diode)	$T_c = 25^\circ\text{C}$			51	A
		$T_c = 80^\circ\text{C}$			38	
V_{SD}	Diode Forward Voltage	$V_{GS} = 0\text{V}, I_S = -51\text{A}$			1.3	V
dv/dt	Peak Diode Recovery ^①				8	V/ns
t_{rr}	Reverse Recovery Time	$I_S = -51\text{A}$ $V_R = 333\text{V}$	$T_j = 25^\circ\text{C}$	700		ns
Q_{rr}	Reverse Recovery Charge	$di/dt = 100\text{A}/\mu\text{s}$	$T_j = 25^\circ\text{C}$	15.4		μC

① dv/dt numbers reflect the limitations of the circuit rather than the device itself.

$$I_S \leq -51\text{A} \quad di/dt \leq 700\text{A}/\mu\text{s} \quad V_R \leq V_{DSS} \quad T_j \leq 150^\circ\text{C}$$

Thermal and package characteristics

Symbol	Characteristic	IGBT	Min	Typ	Max	Unit
R_{thJC}	Junction to Case Thermal Resistance				0.32	°C/W
V_{ISOL}	RMS Isolation Voltage, any terminal to case $t = 1$ min, $I_{isol} < 1$ mA, 50/60Hz		2500			V
T_J	Operating junction temperature range		-40		150	°C
T_{STG}	Storage Temperature Range		-40		125	
T_C	Operating Case Temperature		-40		100	
Torque	Mounting torque	To heatsink	M6	3	5	N.m
Wt	Package Weight				250	g

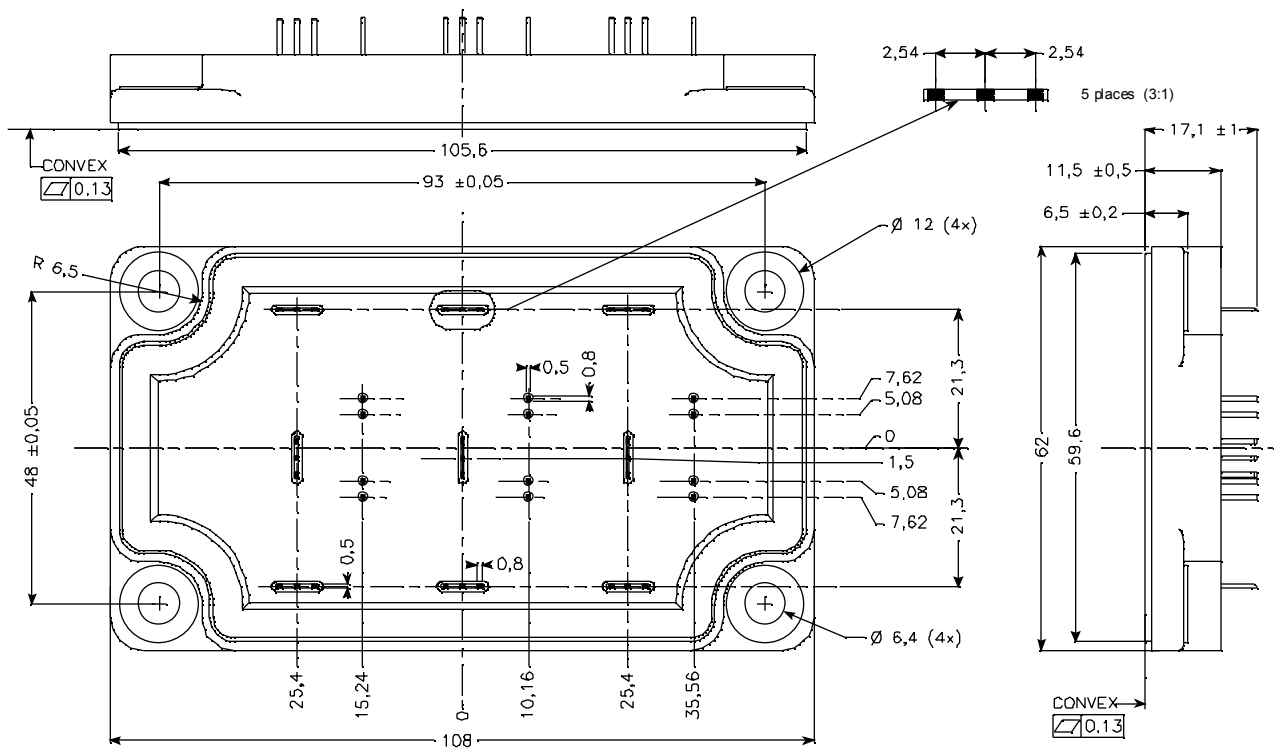
SP6-P Package outline (dimensions in mm)

See application note 1902 - Mounting Instructions for SP6-P (12mm) Power Modules on www.microsemi.com

Typical Performance Curve

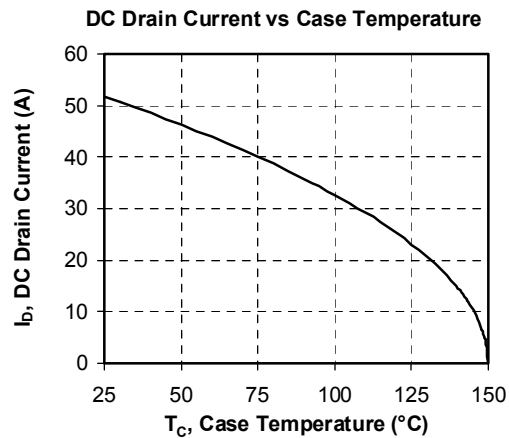
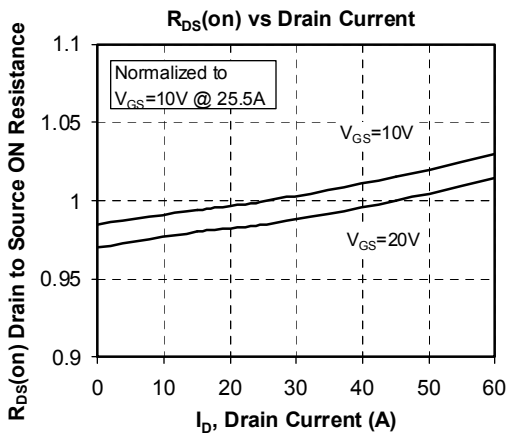
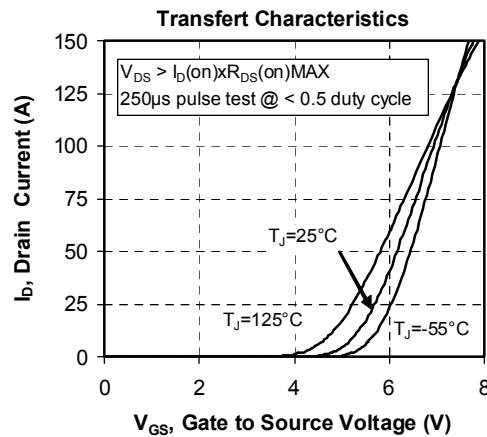
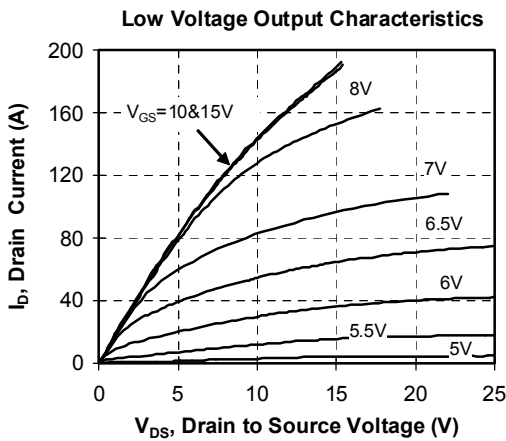
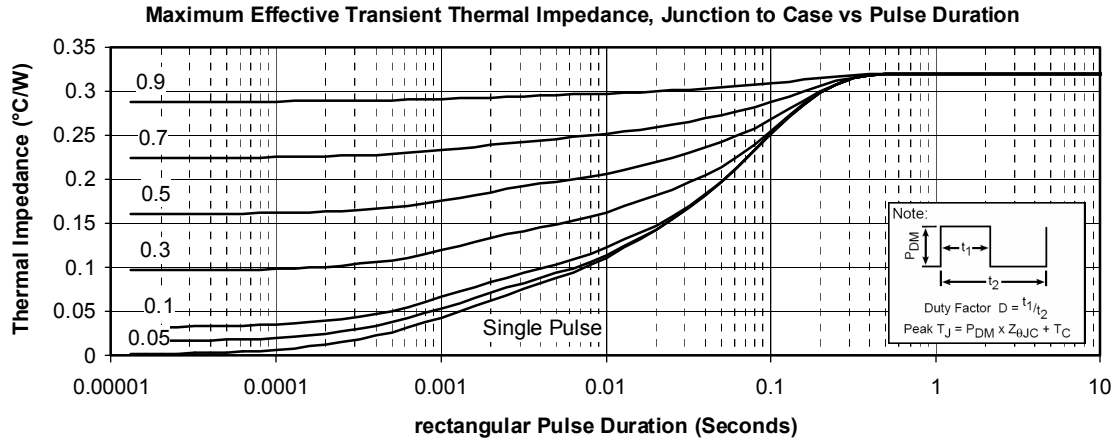

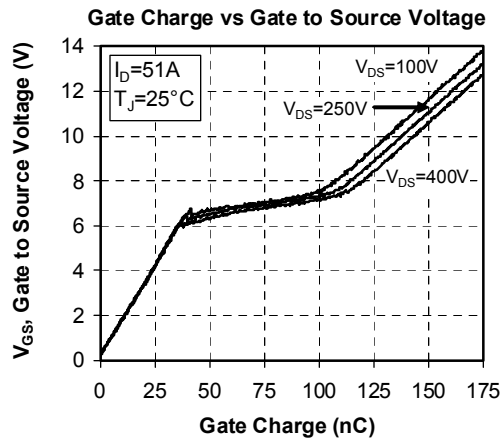
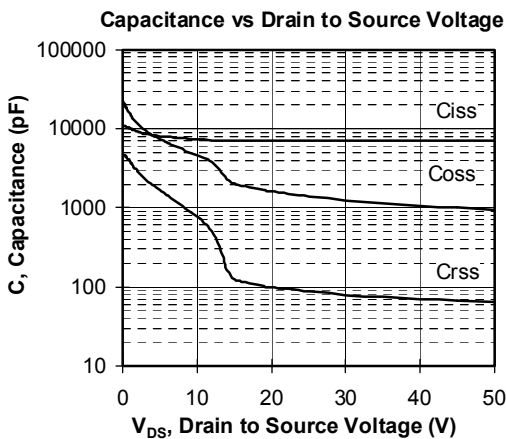
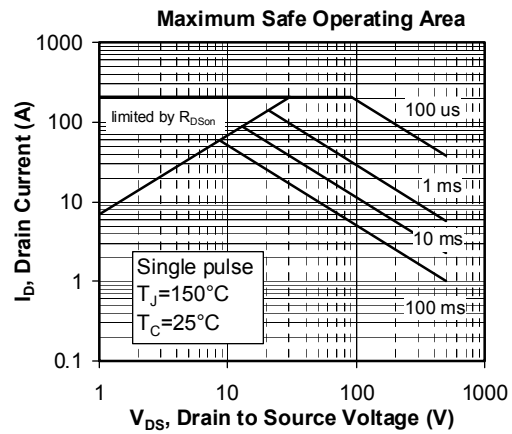
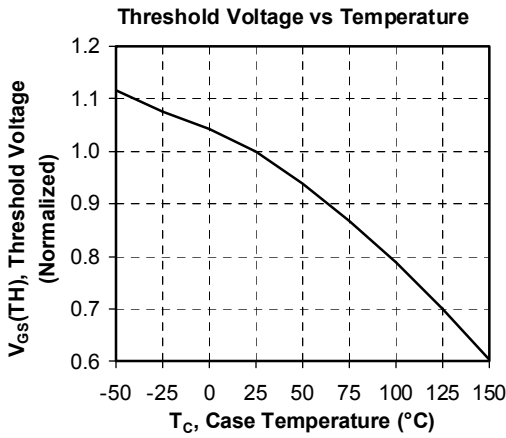
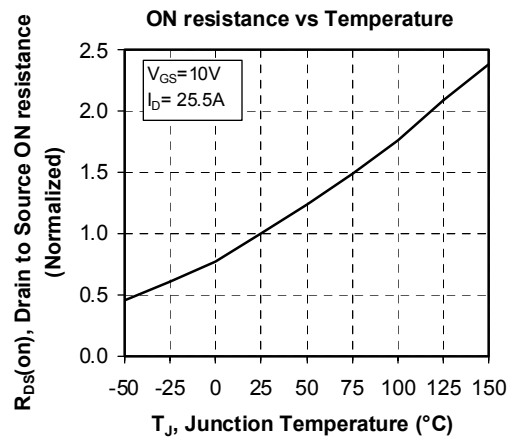
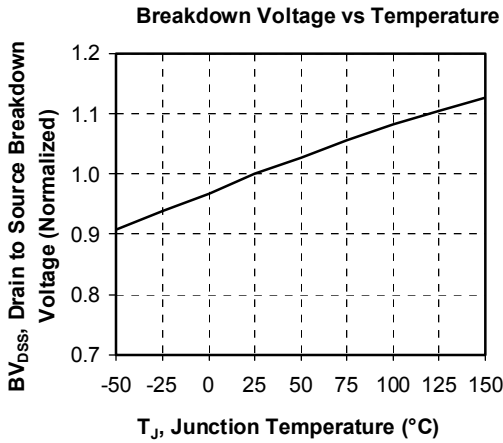

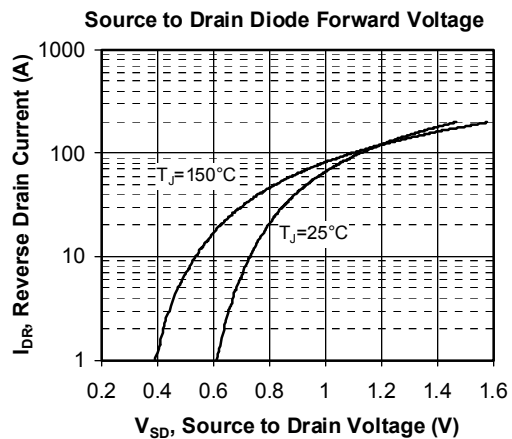
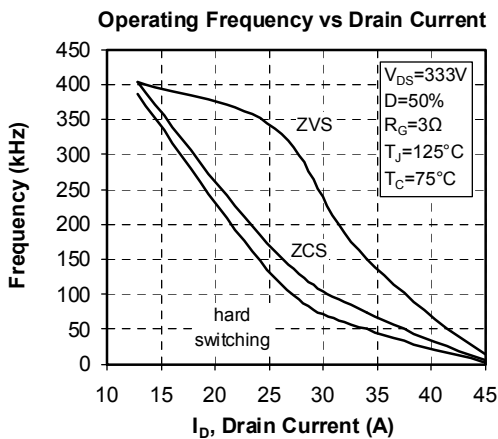
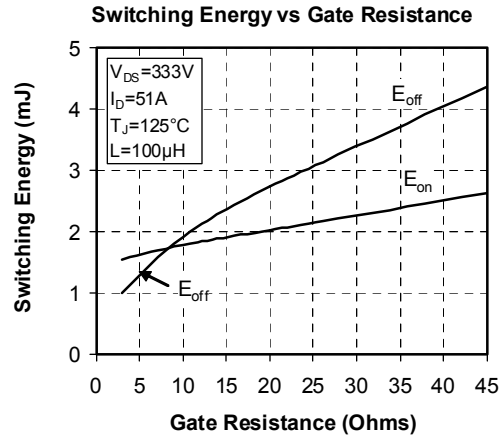
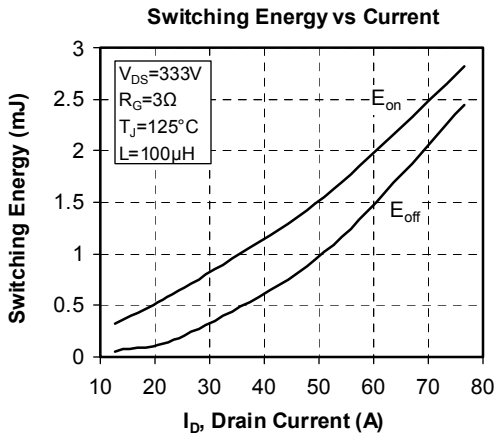
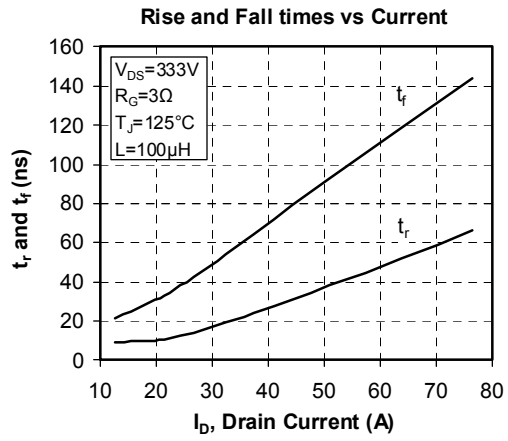
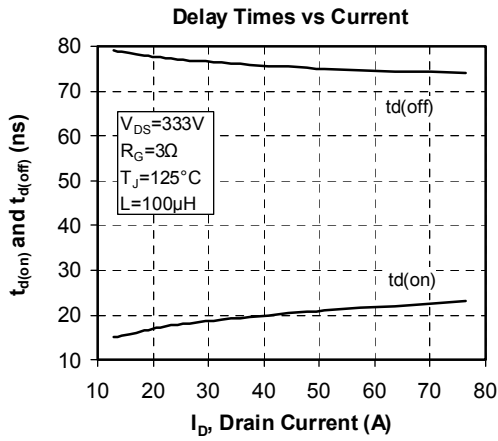

Microsemi reserves the right to change, without notice, the specifications and information contained herein

Microsemi's products are covered by one or more of U.S. patents 4,895,810 5,045,903 5,089,434 5,182,234 5,019,522 5,262,336 6,503,786 5,256,583 4,748,103 5,283,202 5,231,474 5,434,095 5,528,058 and foreign patents. U.S. and Foreign patents pending. All Rights Reserved.