



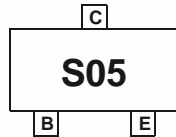
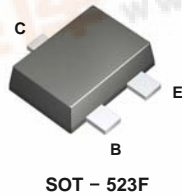
November 2006

# FJY3005R

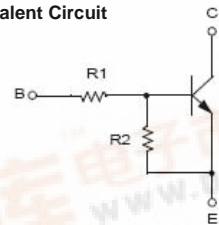
## NPN Epitaxial Silicon Transistor

### Features

- Switching circuit, Inverter, Interface circuit, Driver Circuit
- Built in bias Resistor (R1=4.7KΩ, R2=10KΩ)
- Complement to FJY4005R



Equivalent Circuit



### Absolute Maximum Ratings\* $T_a = 25^\circ\text{C}$ unless otherwise noted

Symbol	Parameter	Value	Units
$V_{CBO}$	Collector-Base Voltage	50	V
$V_{CEO}$	Collector-Emitter Voltage	50	V
$V_{EBO}$	Emitter-Base Voltage	10	V
$I_C$	Collector Current	100	mA
$T_{STG}$	Storage Temperature Range	-55~150	$^\circ\text{C}$
$T_J$	Junction Temperature	150	$^\circ\text{C}$
$P_C$	Collector Power Dissipation, by $R_{\theta JA}$	200	mW

\* These ratings are limiting values above which the serviceability of any semiconductor device may be impaired.

### Thermal Characteristics\* $T_a = 25^\circ\text{C}$ unless otherwise noted

Symbol	Parameter	Max	Units
$R_{\theta JA}$	Thermal Resistance, Junction to Ambient	600	$^\circ\text{C}/\text{W}$

\* Minimum land pad size.

### Electrical Characteristics\* $T_C = 25^\circ\text{C}$ unless otherwise noted

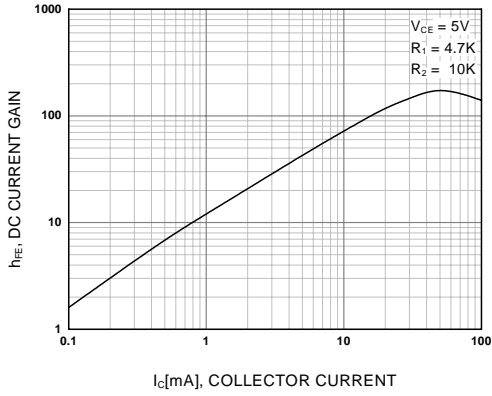
Symbol	Parameter	Test Condition	MIN	Typ	MAX	Units
$V_{(BR)CBO}$	Collector-Emitter Breakdown Voltage	$I_C = 10 \mu\text{A}, I_E = 0$	50			V
$V_{(BR)CEO}$	Collector-Base Breakdown Voltage	$I_C = 100 \mu\text{A}, I_B = 0$	50			V
$I_{CBO}$	Collector-Cutoff Current	$V_{CB} = 40 \text{ V}, I_E = 0$			0.1	$\mu\text{A}$
$h_{FE}$	DC Current Gain	$V_{CE} = 5 \text{ V}, I_C = 5 \text{ mA}$	30			
$V_{CE(sat)}$	Collector-Emitter Saturation Voltage	$I_C = 10 \text{ mA}, I_B = 0.5 \text{ mA}$			0.3	V
$f_r$	Current Gain - Bandwidth Product	$V_{CE} = 10 \text{ V}, I_C = 5 \text{ mA}$		250		MHz
$C_{cb}$	Output Capacitance	$V_{CB} = 10 \text{ V}, I_E = 0, f = 1.0 \text{ MHz}$		3.7		pF
$V_{I(off)}$	Input Off Voltage	$V_{CE} = 5 \text{ V}, I_C = 100 \mu\text{A}$	0.3			V
$V_{I(on)}$	Input On Voltage	$V_{CE} = 0.3 \text{ V}, I_C = 20 \text{ mA}$			2.5	V
$R_1$	Input Resistor		3.2	4.7	6.2	$\text{K}\Omega$
$R_1/R_2$	Resistor Ratio		0.42	0.47	0.52	

\* Pulse Test:  $PW \leq 300 \mu\text{s}$ , Duty Cycle  $\leq 2\%$

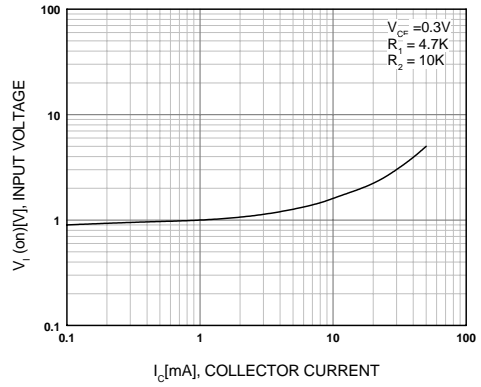


## Typical Performance Characteristics

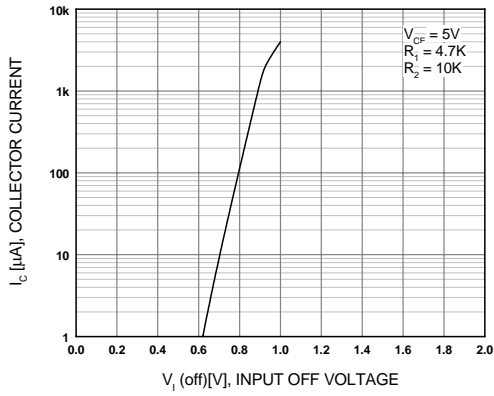
**Figure 1. DC current Gain**



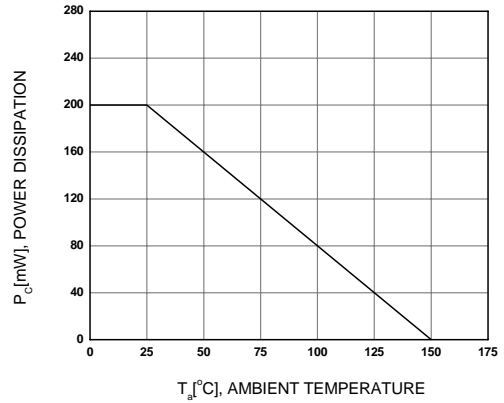
**Figure 2. Input On Voltage**



**Figure 3. Input off Voltage**

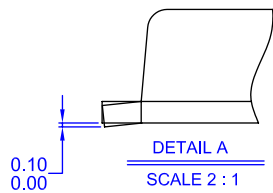
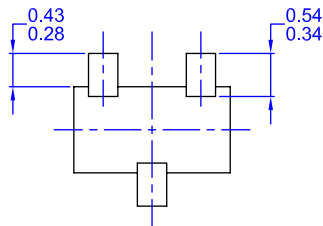
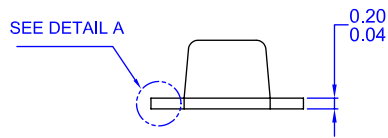
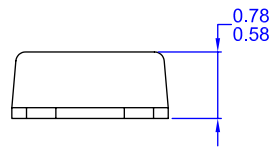
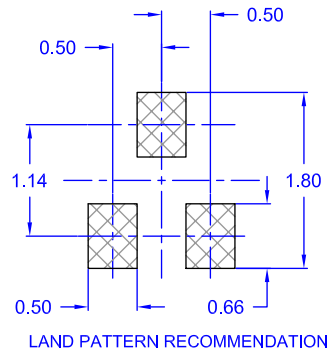
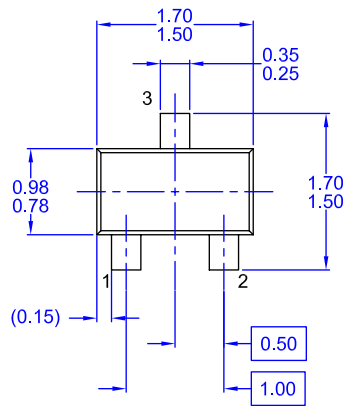


**Figure 4. Power Derating**



# Package Dimensions

## SOT-523F



- NOTES: UNLESS OTHERWISE SPECIFIED  
 A) THIS PACKAGE CONFORMS TO EIAJ SC89 PACKAGING STANDARD.  
 B) ALL DIMENSIONS ARE IN MILLIMETERS.  
 C) DIMENSIONS ARE EXCLUSIVE OF BURRS, MOLD FLASH, AND TIE BAR EXTRUSIONS.

Dimensions in Millimeters

## FAIRCHILD SEMICONDUCTOR TRADEMARKS

The following are registered and unregistered trademarks Fairchild Semiconductor owns or is authorized to use and is not intended to be an exhaustive list of all such trademarks.

ACE <sub>x</sub> ™	FACT Quiet Series™	OCX™	SILENT SWITCHER®	UniFET™
ActiveArray™	GlobalOptoisolator™	OCXPro™	SMART START™	VCX™
Bottomless™	GTO™	OPTOLOGIC®	SPM™	Wire™
Build it Now™	HiSeC™	OPTOPLANAR™	Stealth™	
CoolFET™	I <sup>2</sup> C™	PACMAN™	SuperFET™	
CROSSVOLT™	i-Lo™	POP™	SuperSOT™-3	
DOME™	ImpliedDisconnect™	Power247™	SuperSOT™-6	
EcoSPARK™	IntelliMAX™	PowerEdge™	SuperSOT™-8	
E <sup>2</sup> C MOS™	ISOPLANAR™	PowerSaver™	SyncFET™	
EnSigna™	LittleFET™	PowerTrench®	TCM™	
FACT®	MICROCOUPLER™	QFET®	TinyBoost™	
FAST®	MicroFET™	QS™	TinyBuck™	
FAST <sub>r</sub> ™	MicroPak™	QT Optoelectronics™	TinyPWM™	
FPS™	MICROWIRE™	Quiet Series™	TinyPower™	
FRFET™	MSX™	RapidConfigure™	TinyLogic®	
	MSXPro™	RapidConnect™	TINYOPTO™	
Across the board. Around the world.™		μSerDes™	TruTranslation™	
The Power Franchise®		ScalarPump™	UHC®	
Programmable Active Droop™				

### DISCLAIMER

FAIRCHILD SEMICONDUCTOR RESERVES THE RIGHT TO MAKE CHANGES WITHOUT FURTHER NOTICE TO ANY PRODUCTS HEREIN TO IMPROVE RELIABILITY, FUNCTION, OR DESIGN. FAIRCHILD DOES NOT ASSUME ANY LIABILITY ARISING OUT OF THE APPLICATION OR USE OF ANY PRODUCT OR CIRCUIT DESCRIBED HEREIN; NEITHER DOES IT CONVEY ANY LICENSE UNDER ITS PATENT RIGHTS, NOR THE RIGHTS OF OTHERS. THESE SPECIFICATIONS DO NOT EXPAND THE TERMS OF FAIRCHILD'S WORLDWIDE TERMS AND CONDITIONS, SPECIFICALLY THE WARRANTY THEREIN, WHICH COVERS THESE PRODUCTS.

### LIFE SUPPORT POLICY

FAIRCHILD'S PRODUCTS ARE NOT AUTHORIZED FOR USE AS CRITICAL COMPONENTS IN LIFE SUPPORT DEVICES OR SYSTEMS WITHOUT THE EXPRESS WRITTEN APPROVAL OF FAIRCHILD SEMICONDUCTOR CORPORATION.

As used herein:

- Life support devices or systems are devices or systems which, (a) are intended for surgical implant into the body, or (b) support or sustain life, or (c) whose failure to perform when properly used in accordance with instructions for use provided in the labeling, can be reasonably expected to result in significant injury to the user.
- A critical component is any component of a life support device or system whose failure to perform can be reasonably expected to cause the failure of the life support device or system, or to affect its safety or effectiveness.

### PRODUCT STATUS DEFINITIONS

#### Definition of Terms

Datasheet Identification	Product Status	Definition
Advance Information	Formative or In Design	This datasheet contains the design specifications for product development. Specifications may change in any manner without notice.
Preliminary	First Production	This datasheet contains preliminary data, and supplementary data will be published at a later date. Fairchild Semiconductor reserves the right to make changes at any time without notice to improve design.
No Identification Needed	Full Production	This datasheet contains final specifications. Fairchild Semiconductor reserves the right to make changes at any time without notice to improve design.
Obsolete	Not In Production	This datasheet contains specifications on a product that has been discontinued by Fairchild semiconductor. The datasheet is printed for reference information only.