

Kingbright

T-1 3/4 (5mm) SOLID STATE LAMP

PRELIMINARY SPEC

Part Number: WP7114RWC/Z

WHITE



ATTENTION
OBSERVE PRECAUTIONS
FOR HANDLING
ELECTROSTATIC
DISCHARGE
SENSITIVE
DEVICES

Features

- LOW POWER CONSUMPTION.
- POPULAR T-1 3/4 DIAMETER PACKAGE.
- GENERAL PURPOSE LEADS.
- RELIABLE AND RUGGED.
- LONG LIFE - SOLID STATE RELIABILITY.
- AVAILABLE ON TAPE AND REEL.
- MOISTURE SENSITIVITY LEVEL : LEVEL 1.
- ELECTROSTATIC DISCHARGE THRESHOLD (HBM):1000V.
- TYP. COLOR TEMPERATURE:6500K.
- COLOR COORDINATES:X=0.33,Y=0.34 ACC. TO CIE1931(WHITE).
- OPTICAL EFFICIENCY: 65.6 lm/W(TYP.)
- COLOR REPRODUCTION INDEX:80.
- RoHS COMPLIANT.

Description

The source color devices are made with InGaN Light Emitting Diode.

Static electricity and surge damage the LEDs.

It is recommended to use a wrist band or anti-electrostatic glove when handling the LEDs.

All devices, equipment and machinery must be electrically grounded.

Applications

- Furniture lighting
- Outdoor displays
- Optical indicators
- Signal and symbol luminaire
- Marker lights (e.g. steps, exit ways, etc.)
- Lighting for special effects (e.g. starry sky)
- Substitute for miniature flashlight

Package Dimensions

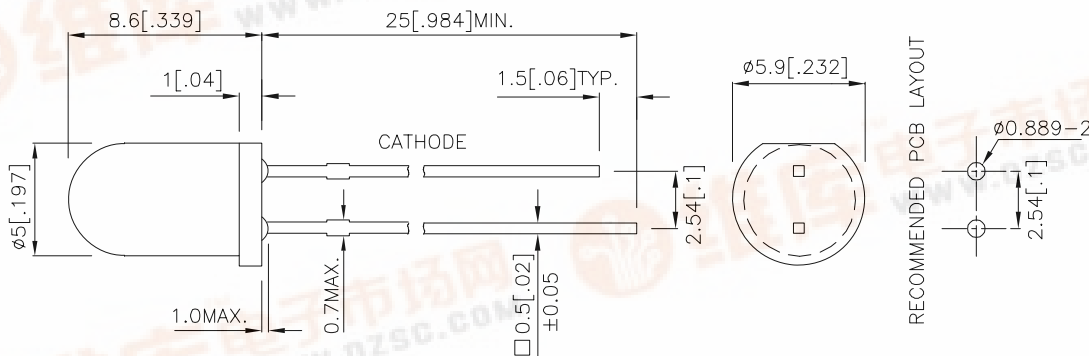

Notes:

1. All dimensions are in millimeters (inches).
2. Tolerance is ±0.25(0.01") unless otherwise noted.
3. Lead spacing is measured where the leads emerge from the package.
4. Specifications are subject to change without notice.

Selection Guide

Part No.	Dice	Lens Type	luminous Intensity ^{Note2} Iv(mcd) @ 20mA		Φ_v (mlm) ^{Note3} @ 20mA	Viewing Angle ^{Note1}
			Min.	Typ.	Typ.	2 θ 1/2
WP7114RWC/Z	WHITE (InGaN)	WATER CLEAR	4700	9500	4200	20°

Absolute Maximum Ratings at T_A=25°C

Parameter	Symbol	Value	Unit
Power dissipation	P _t	111	mW
Reverse Voltage	V _R	5	V
Junction temperature	T _J	110	°C
Operating Temperature	T _{op}	-40 To +85	°C
Storage Temperature	T _{stg}	-40 To +100	°C
DC Forward Current	I _F	30	mA
Peak Forward Current ^{Note4}	I _{FM}	100	mA
Thermal resistance Junction/ambient ^{Note5}	R _{th JA}	350	°C/W
Junction/solder point	R _{th JS}	130	°C/W

Notes:

1. θ 1/2 is the angle from optical centerline where the luminous intensity is 1/2 the optical centerline value.
- 2.Luminous intensity is measured by a current pulse of 10ms at a tolerance of \pm 15%.
- 3.The typical data of Luminous Flux can only reflect statistical figures, actual parameters of individual product could differ from the typical data.
For the purpose of product enhancement, the typical data is subject to change without prior notice.
- 4.1/10 Duty Cycle, 0.1ms Pulse Width.
- 5.R_{th}(J-A) Results from mounting on PC board FR4 (pad size \geq 16 mm² per pad),

Electrical / Optical Characteristics at T_A=25°C

Parameter	Symbol	Value	Unit
Chromaticity coordinate x acc.to CIE1931 I _F =20mA [Typ.]	X ^{Note1}	0.33	-
Chromaticity coordinate y acc.to CIE1931 I _F =20mA [Typ.]	Y ^{Note1}	0.34	-
Forward Voltage I _F =20mA [Min.]	V _F ^{Note2}	2.7	V
Forward Voltage I _F =20mA [Typ.]		3.2	
Forward Voltage I _F =20mA [Max.]		3.7	
Reverse Current (V _R =5V) [Typ.]	I _R	0.01	μ A
Reverse Current (V _R =5V) [Max.]		10	
Temperature coefficient of x I _F =20mA, -10°C \leq T \leq 100°C [Typ.]	TC _x	-0.1	10 ⁻³ /°C
Temperature coefficient of y I _F =20mA, -10°C \leq T \leq 100°C [Typ.]	TC _y	-0.2	10 ⁻³ /°C
Temperature coefficient of V _F I _F =20mA, -10°C \leq T \leq 100°C [Typ.]	TC _v	-2.5	mV/°C

Notes:

- 1.Chromaticity coordinates are measured by a current pulse of 20ms with a tolerance of \pm 0.01 in X and Y color coordinates.
- 2.Forward voltage is measured with a current pulse of 10ms at a tolerance of \pm 0.1V.

Kingbright

Brightness codes

Code.	luminous Intensity ^{Note1} Iv(mcd) @ 20mA		Φ_v (mlm) ^{Note2} @ 20mA
	Min.	Max.	Typ.
ZD	4700	6500	2500
ZE	5700	7500	2900
ZF	6700	8500	3400
ZG	7500	10000	3900
ZH	8000	12000	4500
ZM	10000	16000	5900
ZN	12000	20000	7500
ZP	16000	24000	9500

Notes:

- 1.Luminous intensity is measured by a current pulse of 10ms at a tolerance of $\pm 15\%$.
- 2.The typical data of Luminous Flux can only reflect statistical figures, actual parameters of individual product could differ from the typical data. For the purpose of product enhancement, the typical data is subject to change without prior notice.

White

WP7114RWC/Z

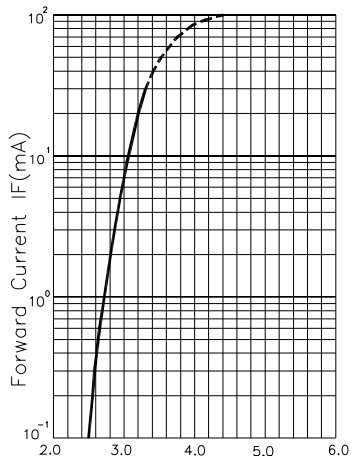

Forward Current (mA)
FORWARD CURRENT Vs.
FORWARD VOLTAGE

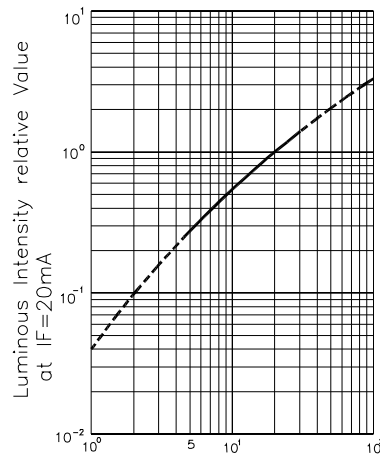

LUMINOUS INTENSITY Vs.
FORWARD CURRENT

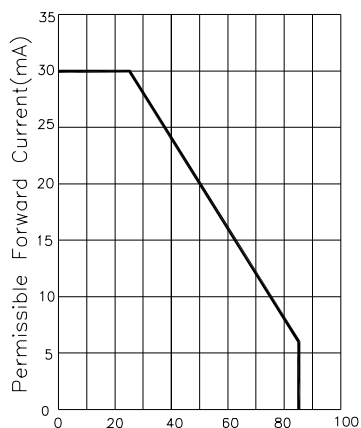

FORWARD CURRENT
DERATING CURVE

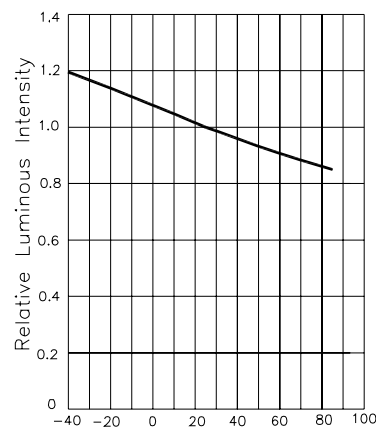

LUMINOUS INTENSITY Vs.
AMBIENT TEMPERATURE

Kingbright

White

WP7114RWC/Z

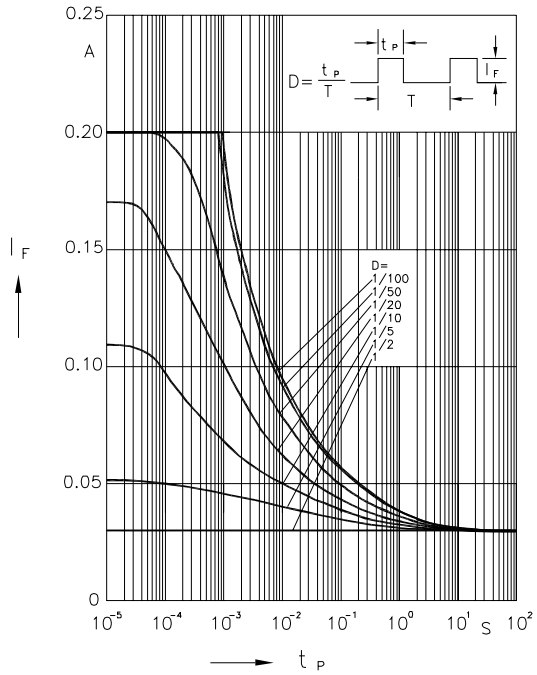

Permissible Pulse Handling Capability
Duty cycle $D = \text{parameter}$, $T_A = 25^\circ\text{C}$

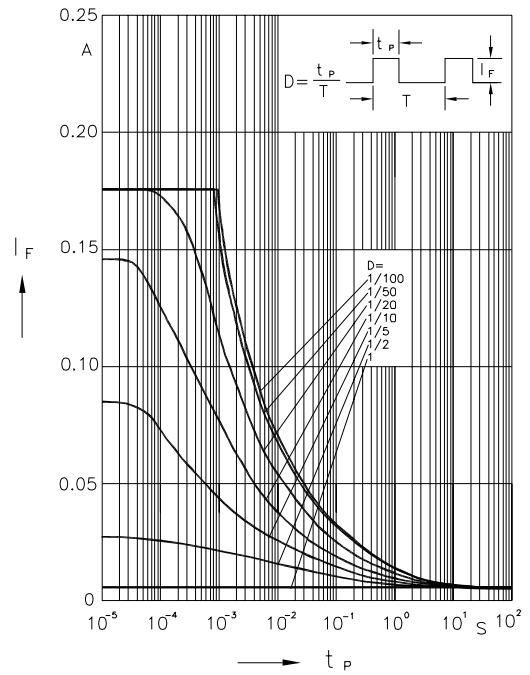

Permissible Pulse Handling Capability
Duty cycle $D = \text{parameter}$, $T_A = 85^\circ\text{C}$

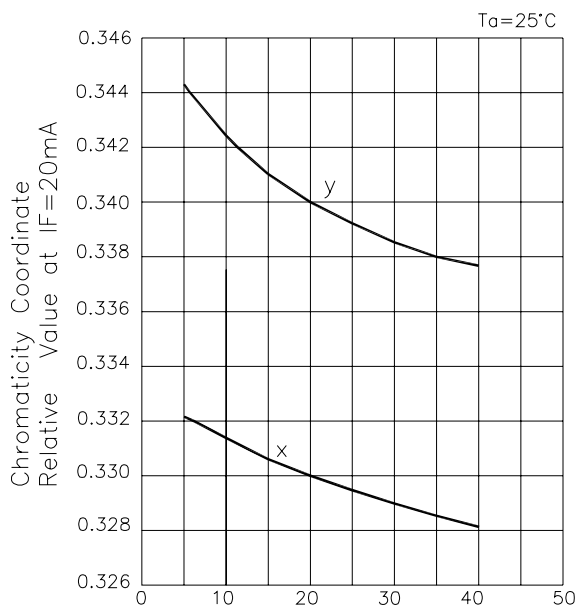

Forward Current (mA)
Chromaticity Coordinate Shift Vs.
Forward Current

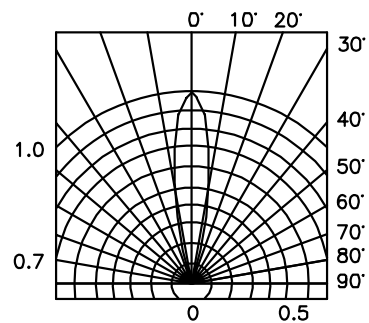
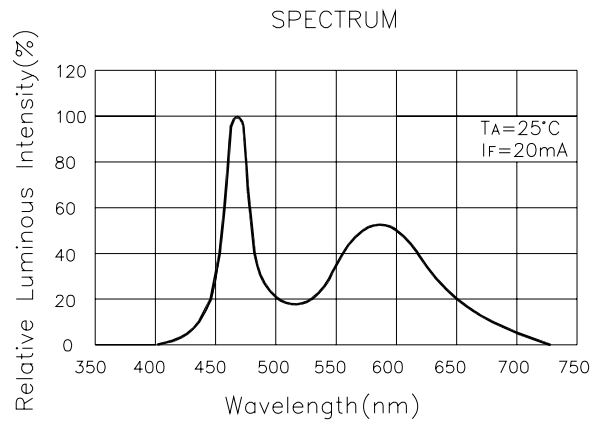

SPATIAL DISTRIBUTION

Kingbright

Color Codes

WP7114RWC/Z

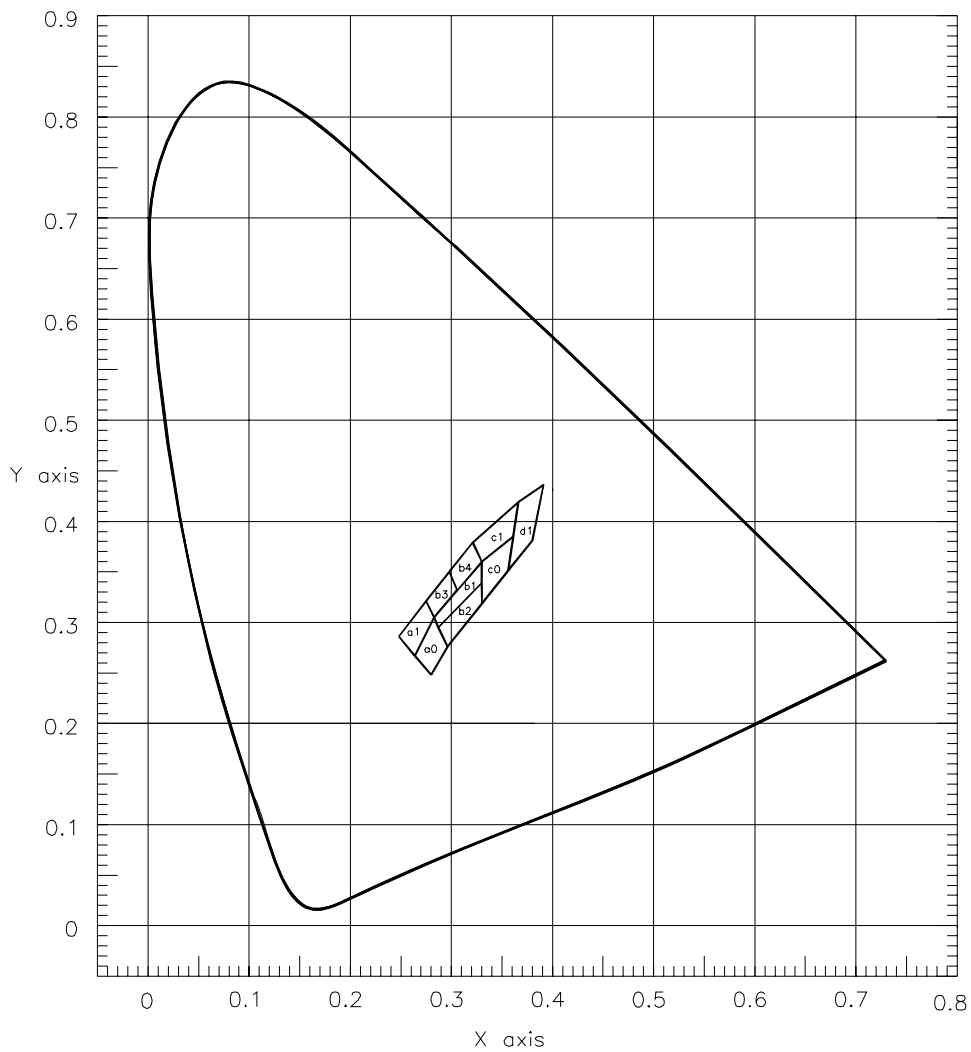

a1				
X	0.248	0.275	0.283	0.264
Y	0.286	0.321	0.305	0.267
b1				
X	0.283	0.330	0.330	0.287
Y	0.305	0.360	0.339	0.295
c1				
X	0.321	0.366	0.361	0.330
Y	0.379	0.419	0.385	0.360

a0				
X	0.264	0.283	0.296	0.280
Y	0.267	0.305	0.276	0.248
b2				
X	0.287	0.330	0.330	0.296
Y	0.295	0.339	0.318	0.276
c0				
X	0.330	0.361	0.356	0.330
Y	0.360	0.385	0.351	0.318

b3				
X	0.275	0.298	0.306	0.283
Y	0.321	0.350	0.332	0.305
b4				
X	0.298	0.321	0.330	0.306
Y	0.350	0.379	0.360	0.332
d1				
X	0.366	0.391	0.380	0.356
Y	0.419	0.436	0.381	0.351

Ta=25°, IF=20mA

Measurement Uncertainty of the Color Coordinates: +/-0.01

WP7114RWC/Z

Wave Soldering Profile For Lead-free Through-hole LED.

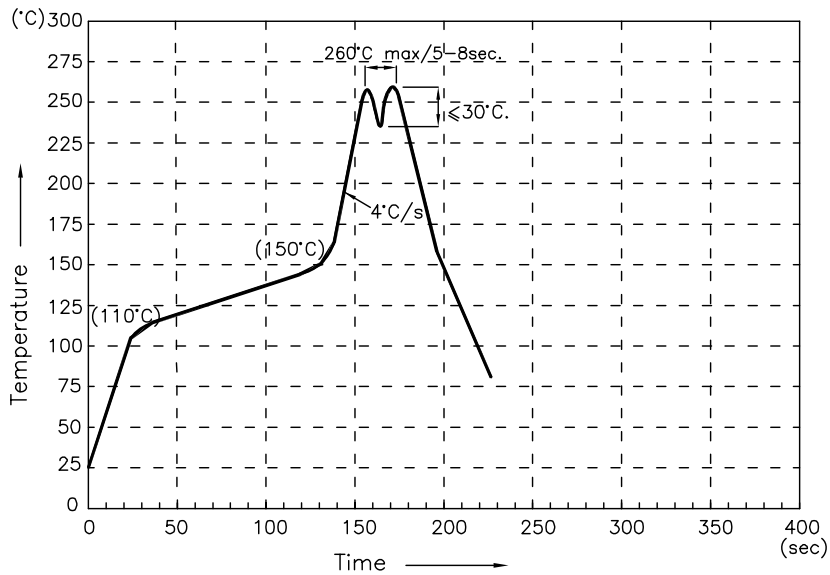

NOTES:

- 1.Recommend the wave temperature 245°C~260°C.The maximum soldering temperature should be less than 260°C.
- 2.Do not apply stress on epoxy resins when temperature is over 85 degree°C.
- 3.The soldering profile apply to the lead free soldering (Sn/Cu/Ag alloy).
- 4.No more than once.

**Recommended Soldering Pattern
(Units : mm; Tolerance: ±0.1)**

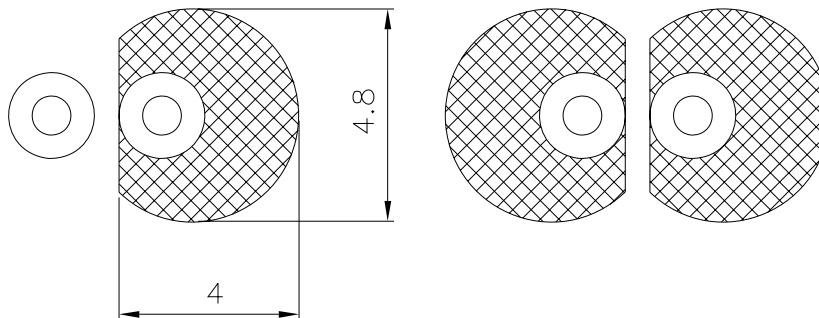

Kingbright

PACKING & LABEL SPECIFICATIONS

WP7114RWC/Z

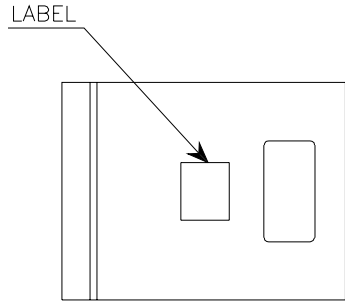
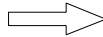
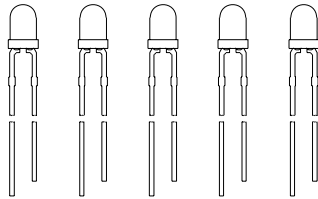

500PCS/BAG



20K / 9# BOX

OUTSIDE LABEL

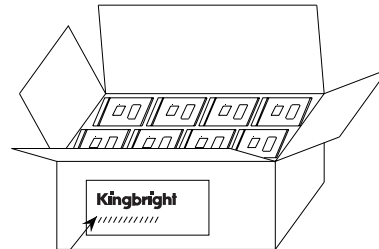
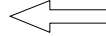

OUTSIDE LABEL

10K / 5# BOX

Kingbright				
Q.C.	<table border="1"> <tr> <td style="text-align: center;">QC</td> </tr> <tr> <td style="text-align: center;">xxx xx. xxxx</td> </tr> <tr> <td style="text-align: center;">PASSED</td> </tr> </table>	QC	xxx xx. xxxx	PASSED
QC				
xxx xx. xxxx				
PASSED				
TYPE NO : WP7114XXX				
QUANTITY : 500 pcs				
S/N : XXX	CODE: XX			
LOT NO : 				
RoHS Compliant				