



Technical Data Sheet

5.0 mm Round LED (T-1 3/4)

3384-15UTC/S400-X10

Features

- Popular T-1 colorless 5mm package.
- High luminous power.
- Typical chromaticity coordinates $x=0.29, y=0.28$ according to CIE1931.
- Bulk, available taped on reel.
- Pb free .
- The product itself will remain within RoHS compliant version.

Descriptions

- The series is designed for application required high luminous intensity.
- The phosphor filled in the reflector converts the blue emission of InGaN chip to ideal white.

Applications

- Outdoor Displays
- Optical Indicators
- Backlighting
- Marker Lights

Device Selection Guide

PART NO.	Chip		Lens Color
	Material	Emitted Color	
3384-15UTC/S400-X10	InGaN/Sapphire	White	Water Clear



Package Dimensions

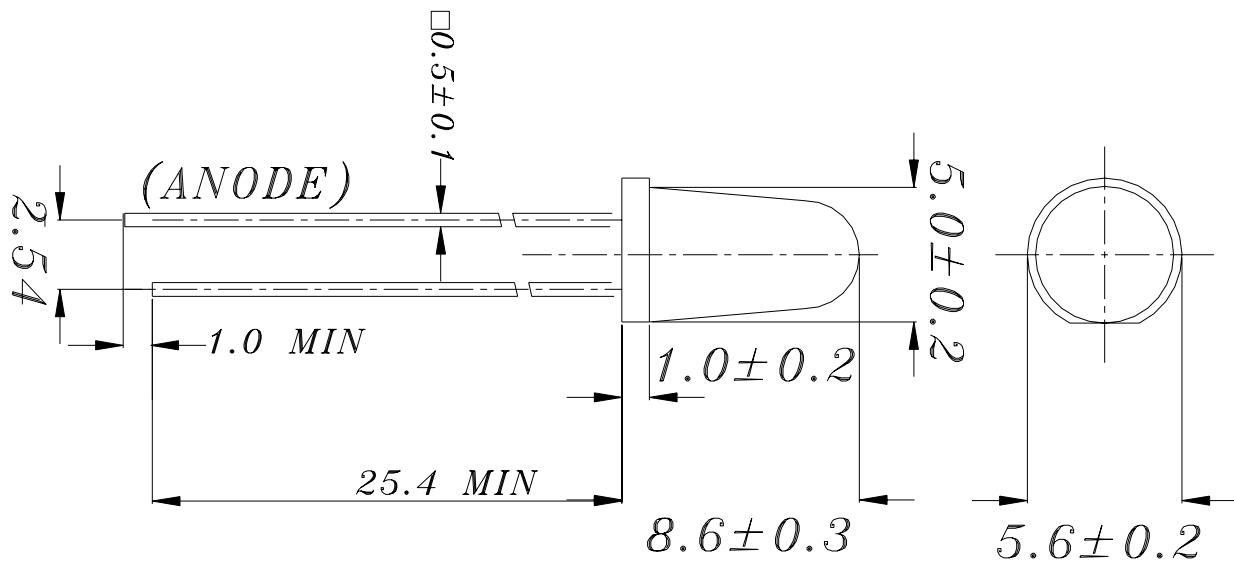

Notes:

- 1.All dimensions are in millimeters, and tolerance is 0.25mm except being specified.
- 2.Lead spacing is measured where the lead emerges from the package.
- 3.Protruded resin under flange is 1.5mm Max. LED.

Absolute Maximum Ratings (Ta=25°C)

Parameter	Symbol	Rating	Unit
Continuous Forward Current	I _F	25	mA
Reverse Voltage	V _R	5	V
Operating Temperature	T _{opr}	-30 ~ +85	°C
Storage Temperature	T _{stg}	-40 ~ +100	°C
Soldering Temperature (T=5 sec)	T _{sol}	260 ± 5	°C
Power Dissipation	P _d	120	mW
Electrostatic Discharge	ESD	150	V

Electro-Optical Characteristics (Ta=25°C)

Parameter	Symbol	Condition	Min.	Typ.	Max.	Units
Forward Voltage	V _F	I _F =20mA	--	3.2	4.0	V
Reverse Current	I _R	V _R =5V	--	--	50	uA
Luminous Intensity	I _V	I _F =20mA	8000	10000	--	mcd
Viewing Angle	2θ 1/2	I _F =20mA	--	20	--	deg
Chromaticity Coordinates	x	I _F =20mA	--	0.29	--	
	y	-----	--	0.28	--	

Luminous Intensity Combination (mcd at 20mA)

I _V Ranks	Z1	Z2	Z3
Min.	8000	10000	13000
Max.	10000	13000	17000

Measurement Uncertainty of Luminous Intensity: ±15%

Forward Voltage Combination (V at 20mA)

V _F Rank	1	2	3	4	5
Min.	3.0	3.2	3.4	3.6	3.8
Max.	3.2	3.4	3.6	3.8	4.0

*Measurement Uncertainty of Forward Voltage : ±0.1V

CIE Chromaticity Diagram]

Color Ranks (IF=20mA , Ta=25°C)

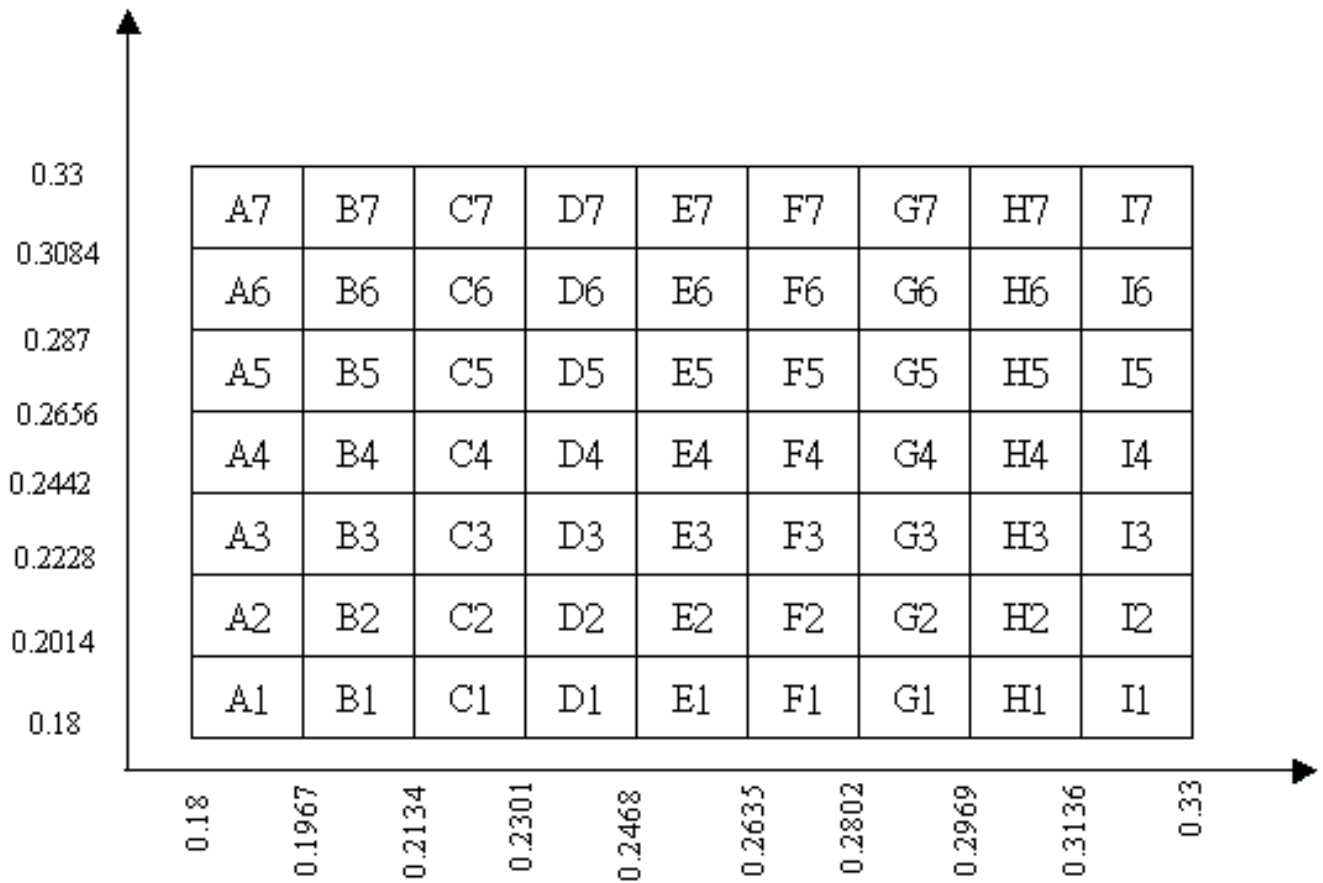

Measurement uncertainty of the color coordinates : ± 0.01

Note:

The setting and inspection for this device please flow the area of x y chromaticity diagram.

Take the upper and lower point for x-axis and y-axis and then put it same parts, x-axis divide into 9 section, y-axis divide into 6 section, total is 63 bins.



3384-15UTC/S400-X10

Typical Electro-Optical Characteristics Curves

Relative Intensity vs. Wavelength

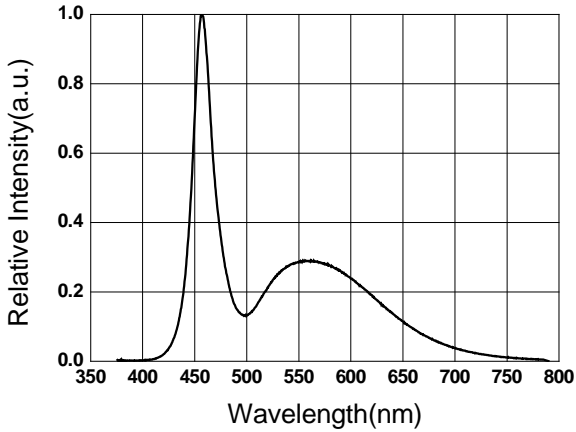

Forward Current vs. Forward Voltage

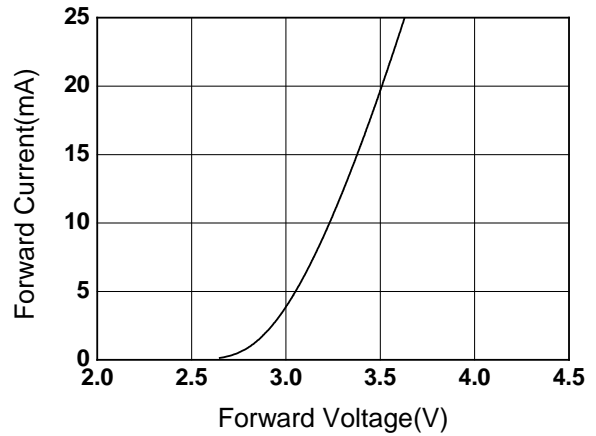

Relative Intensity vs. Forward Current

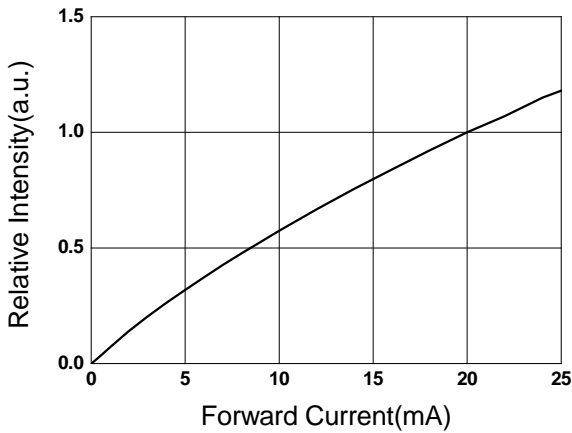

Forward Current vs. Ambient Temp.

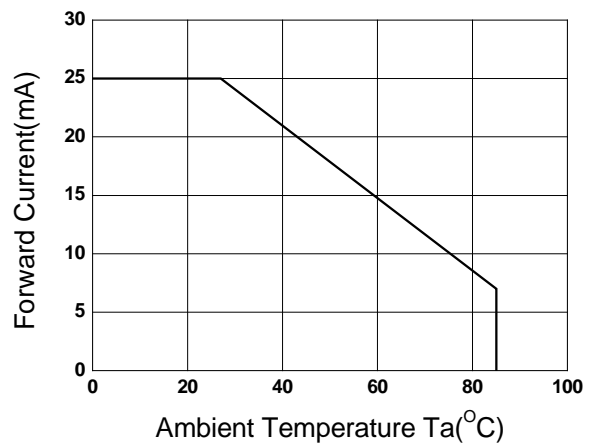

Chromaticity Coordinate vs. Forward Current

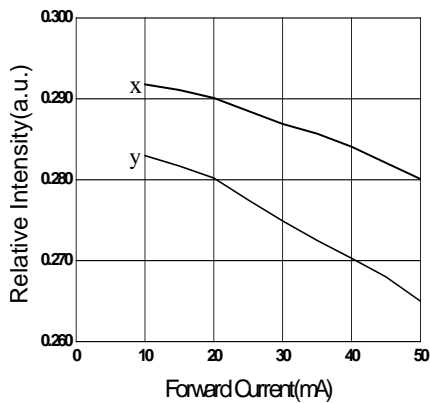

Relative Intensity vs. Angle Dispacemen

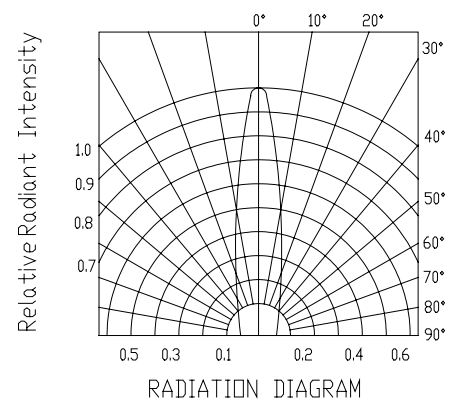



3384-15UTC/S400-X10

Label Form Specification



CPN: Customer's Production Number
P/N : Production Number
QTY: Packing Quantity
CAT: IV&VF Rank
HUE: Color Rank
REF: Reference
LOT No: Lot Number
MADE IN TAIWAN: Production Place

Notes

1. Above specification may be changed without notice. EVERLIGHT will reserve authority on material change for above specification.
2. When using this product, please observe the absolute maximum ratings and the instructions for using outlined in these specification sheets. EVERLIGHT assumes no responsibility for any damage resulting from use of the product which does not comply with the absolute maximum ratings and the instructions included in these specification sheets.
3. These specification sheets include materials protected under copyright of EVERLIGHT corporation. Please don't reproduce or cause anyone to reproduce them without EVERLIGHT's consent.

EVERLIGHT ELECTRONICS CO., LTD.
*Office: No 25, Lane 76, Sec 3, Chung Yang Rd,
Tucheng, Taipei 236, Taiwan, R.O.C*

*Tel: 886-2-2267-2000, 2267-9936
Fax: 886-2267-6244, 2267-6189, 2267-6306
<http://www.everlight.com>*