

NOTE  
 1. 嵌合相手: 51382シリーズ  
 2. 偶数極 (列) に適用。  
 3. キングは両外側の位置に付加。  
 4. 製品番号 MATERIAL NO.

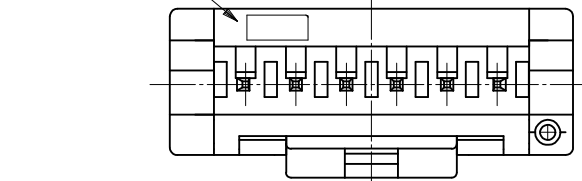
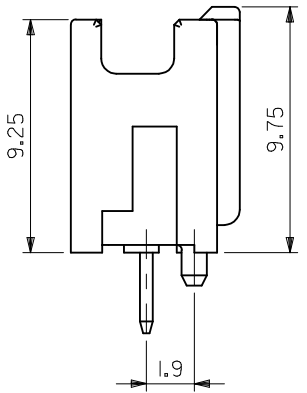
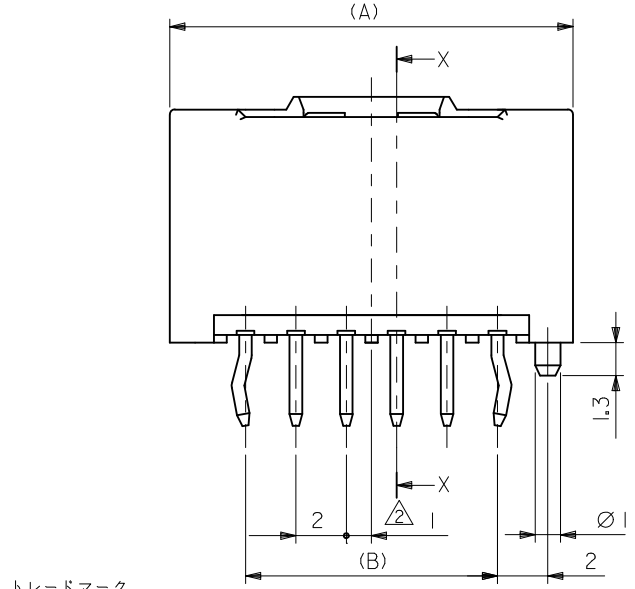
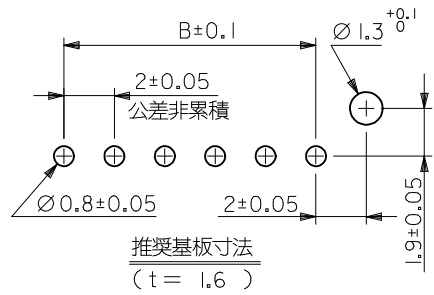

MATERIAL  
 ピン : 黄銅, 錫メッキ  
 ハウジング: PBT

55932-\*\*\*\*  
 極数 CIRCUIT SIZE

色 COLOR
10 自然色 (白) NATURAL (WHITE)
11 黒 BLACK
12 赤 RED
13 黄 YELLOW
14 青 BLUE
15 桃 PINK
16 緑 GREEN
17 茶 BROWN
18 橙 ORANGE
19 紫 VIOLET
41 灰 GRAY
43 蛍光黄 FLUORESCENCE YELLOW
44 水 PALE BLUE
46 黄緑 YELLOWISH GREEN

31	28	34	55932-15**	15
29	26	32	55932-14**	14
27	24	30	55932-13**	13
25	22	28	55932-12**	12
23	20	26	55932-11**	11
21	18	24	55932-10**	10
19	16	22	55932-09**	9
17	14	20	55932-08**	8
15	12	18	55932-07**	7
13	10	16	55932-06**	6
11	8	14	55932-05**	5
9	6	12	55932-04**	4
7	4	10	55932-03**	3
5	2	8	55932-02**	2
C	B	A	MATERIAL NO. CKT.	

MODEL NO. : 55932-\*\*\*\*

REVISED EC NO: J2016-0482 DRWN: MIYABE 2015/10/15 CHKD: KASAKAWA 2015/11/10 APPR: NUKITA 2015/12/24	GENERAL TOLERANCES (UNLESS SPECIFIED)		DIMENSION STYLE MM ONLY		SCALE ---	DESIGN UNITS METRIC	THIRD ANGLE PROJECTION
	0.25 UNDER	UNDER	±0.03	DRAWN BY T. NIITSU	DATE '02/02/08	TITLE 2.0 W/B SINGLE CONN. PLUG HOUSING ASS'Y ST -LEAD FREE-	
	0.25 OVER	0.5 UNDER	±0.05	CHECKED BY K. ASAKAWA	DATE '03/06/12		
	0.5 OVER	1.0 UNDER	±0.1	APPROVED BY T. YAMAGUCHI	DATE '03/06/12		
	1.0 OVER	10 UNDER	±0.2	MATERIAL NO.	DOCUMENT NO.	SD-55932-002	
10 OVER	30 UNDER	±0.25	SEE CHART		SHEET NO. 1 OF 2		
30 OVER		±0.3	THIS DRAWING CONTAINS INFORMATION THAT IS PROPRIETARY TO MOLEX INCORPORATED AND SHOULD NOT BE USED WITHOUT WRITTEN PERMISSION				
ANGULAR ±3 °			DRAFT WHERE APPLICABLE MUST REMAIN WITHIN DIMENSIONS				

10 9 8 7 6 5 4 3 2 1

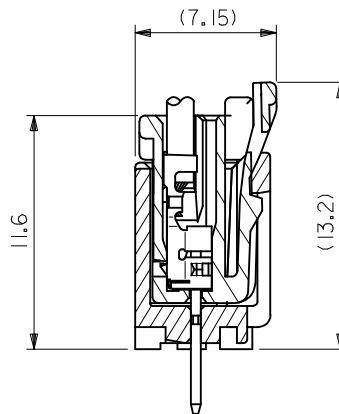
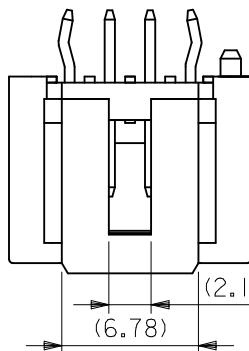
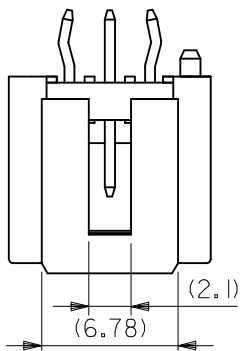
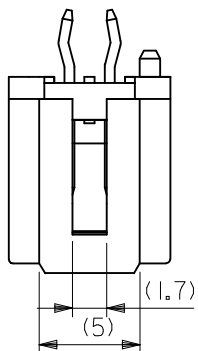

嵌合断面図

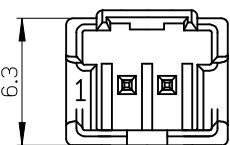

2 CIRCUIT

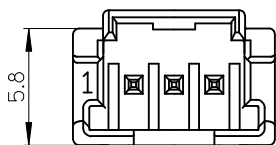

3 CIRCUIT

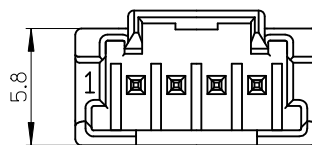

4 CIRCUIT 以上

MODEL NO. : 55932-\*\*\*\*

<b>REVISED</b> EC NO: J2016-0482 DRWN:IMIYABE 2015/10/09 CHKD:KASAKAWA 2015/11/10 APPR:NUKITA 2015/12/24	GENERAL TOLERANCES (UNLESS SPECIFIED)			DIMENSION STYLE <b>MM ONLY</b>		SCALE ---	DESIGN UNITS <b>METRIC</b>	THIRD ANGLE PROJECTION		
	0.25 UNDER	UNDER	±0.03	DRAWN BY	DATE	TITLE				
	0.25 OVER	0.5 UNDER	±0.05	T.NIITSU	'02/02/08	<b>2.0 W/B SINGLE CONN.                  PLUG HOUSING ASS'Y ST                  -LEAD FREE-</b>				
	0.5 OVER	1.0 UNDER	±0.1	K.ASAKAWA	'03/06/12					
	1.0 OVER	10 UNDER	±0.2	APPROVED BY		DATE	<b>molex</b> DOCUMENT NO. SD-55932-002 SHEET NO. 2 OF 2			
10 OVER	30 UNDER	±0.25	T.YAMAGUCHI		'03/06/12					
30 OVER		±0.3	MATERIAL NO.			SEE SHEET 1				
ANGULAR ±3 °			DRAFT WHERE APPLICABLE MUST REMAIN WITHIN DIMENSIONS			SIZE <b>A3</b>	THIS DRAWING CONTAINS INFORMATION THAT IS PROPRIETARY TO MOLEX INCORPORATED AND SHOULD NOT BE USED WITHOUT WRITTEN PERMISSION			

9 8 7 6 5 4 3 2 1