

400MHz Slew Enhanced VFAs

The EL5x02 and EL5x03 families represent high-speed VFAs based on a CFA amplifier architecture. This gives the typical high slew rate benefits of a CFA family along with the stability and ease of use associated with the VFA type architecture. With slew rates of 3500V/μs this family of devices enables the use of voltage feedback amplifiers in a space where the only alternative has been current feedback amplifiers. This family will also be available in single, dual, and triple versions, with 200MHz, 400MHz, and 750MHz versions. These are all available in single, dual, and triple versions.

Both families operate on single 5V or ±5V supplies from minimum supply current. EL5x02 also features an output enable function, which can be used to put the output in to a high-impedance mode. This enables the outputs of multiple amplifiers to be tied together for use in multiplexing applications.

Typical applications for these families will include cable driving, filtering, A-to-D and D-to-A buffering, multiplexing and summing within video, communications, and instrumentation designs.

Features

- Operates off 3V, 5V, or ±5V applications
- Power-down to 0μA (EL5x02)
- -3dB bandwidth = 400MHz
- ±0.1dB bandwidth = 50MHz
- Low supply current = 5mA
- Slew rate = 3500V/μs
- Low offset voltage = 5mV max
- Output current = 140mA
- A_{VOL} = 2000
- Diff gain/phase = 0.01%/0.01°

Applications

- Video amplifiers
- PCMCIA applications
- A/D drivers
- Line drivers
- Portable computers
- High speed communications
- RGB applications
- Broadcast equipment
- Active filtering

Ordering Information

PART NUMBER	PACKAGE	TAPE & REEL	PKG. DWG. #
EL5102IS	8-Pin SO	-	MDP0027
EL5102IS-T7	8-Pin SO	7"	MDP0027
EL5102IS-T13	8-Pin SO	13"	MDP0027
EL5102IW-T7	6-Pin SOT-23	7" (3K pcs)	MDP0038
EL5102IW-T7A	6-Pin SOT-23	7" (250 pcs)	MDP0038
EL5103IC-T7	5-Pin SC-70	7" (3K pcs)	P5.049
EL5103IC-T7A	5-Pin SC-70	7" (250 pcs)	P5.049
EL5103IW-T7	5-Pin SOT-23	7" (3K pcs)	MDP0038
EL5103IW-T7A	5-Pin SOT-23	7" (250 pcs)	MDP0038
EL5202IY	10-Pin MSOP	-	MDP0043
EL5202IY-T7	10-Pin MSOP	7"	MDP0043

PART NUMBER	PACKAGE	TAPE & REEL	PKG. DWG. #
EL5202IY-T13	10-Pin MSOP	13"	MDP0043
EL5203IS	8-Pin SO	-	MDP0027
EL5203IS-T7	8-Pin SO	7"	MDP0027
EL5203IS-T13	8-Pin SO	13"	MDP0027
EL5203IY	8-Pin MSOP	-	MDP0043
EL5203IY-T7	8-Pin MSOP	7"	MDP0043
EL5203IY-T13	8-Pin MSOP	13"	MDP0043
EL5302IU	16-Pin QSOP	-	MDP0040
EL5302IU-T7	16-Pin QSOP	7"	MDP0040
EL5302IU-T13	16-Pin QSOP	13"	MDP0040



EL5102, EL5103, EL5202, EL5203, EL5302

Pinouts

**EL5102
(6-PIN SOT-23)
TOP VIEW**

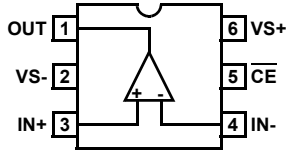

**EL5103
(5-PIN SOT-23)
TOP VIEW**

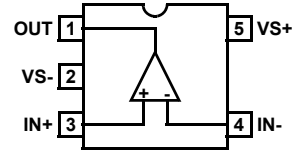

**EL5102
(8-PIN SO)
TOP VIEW**

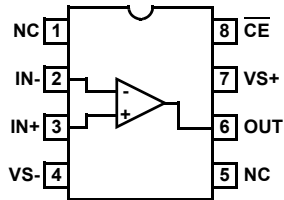

**EL5203
(8-PIN SO, MSOP)
TOP VIEW**

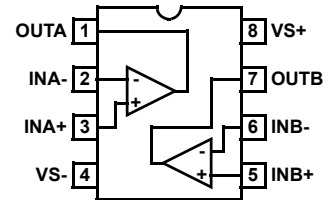

**EL5202
(10-PIN MSOP)
TOP VIEW**

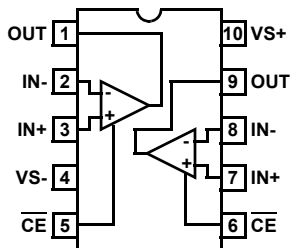

**EL5302
(16-PIN QSOP)
TOP VIEW**

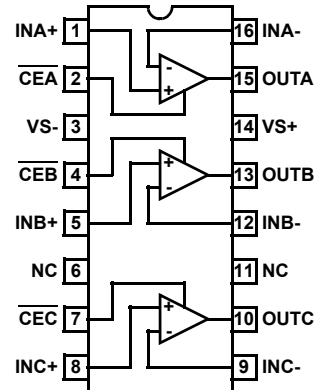

EL5102, EL5103, EL5202, EL5203, EL5302

Absolute Maximum Ratings (T_A = 25°C)

Supply Voltage between V _{S+} and GND	13.2V	Maximum Current into I _{N+} , I _{N-} , \overline{CE}	±5mA
Input Voltage	±V _S	Power Dissipation	See Curves
Differential Input Voltage	±4V	Storage Temperature Range	-65°C to +150°C
Maximum Continuous Output Current	80mA	Ambient Operating Temperature Range	-40°C to +85°C
		Operating Junction Temperature	150°C

CAUTION: Stresses above those listed in "Absolute Maximum Ratings" may cause permanent damage to the device. This is a stress only rating and operation of the device at these or any other conditions above those indicated in the operational sections of this specification is not implied.

IMPORTANT NOTE: All parameters having Min/Max specifications are guaranteed. Typical values are for information purposes only. Unless otherwise noted, all tests are at the specified temperature and are pulsed tests, therefore: T_J = T_C = T_A

DC Electrical Specifications V_{S+} = +5V, V_{S-} = -5V, T_A = 25°C, R_L = 150Ω, V_{ENABLE} = +5V, unless otherwise specified.

PARAMETER	DESCRIPTION	CONDITIONS	MIN	TYP	MAX	UNIT
V _{OS}	Offset Voltage	EL5102, EL5103, EL5202, EL5203		1	5	mV
		EL5302		2	8	mV
TCV _{OS}	Offset Voltage Temperature Coefficient	Measured from T _{MIN} to T _{MAX}		10		μV/°C
I _B	Input Bias Current	V _{IN} = 0V	-12	2	12	μA
I _{OS}	Input Offset Current	V _{IN} = 0V	-8	1	8	μA
TCI _{OS}	Input Bias Current Temperature Coefficient	Measured from T _{MIN} to T _{MAX}		50		nA/°C
PSRR	Power Supply Rejection Ratio	V _S = ±4.75V to ±5.25V	-70	-80		dB
CMRR	Common Mode Rejection Ratio	V _{CM} = -3V to 3.0V	-60	-80		dB
CMIR	Common Mode Input Range	Guaranteed by CMRR test	-3	±3.3	3	V
R _{IN}	Input Resistance	Common mode	200	400		kΩ
C _{IN}	Input Capacitance	SO package		1		pF
I _{S,ON}	Supply Current - Enabled per amplifier		4.6	5.2	5.8	mA
I _{S,OFF}	Supply Current - Shut-down per amplifier	V _{S+}	+1	0	+25	μA
		V _{S-}	-25	7	-1	μA
AVOL	Open Loop Gain	V _{OUT} = ±2.5V, R _L = 1kΩ to GND	58	66		dB
		V _{OUT} = ±2.5V, R _L = 150Ω to GND		60		dB
V _{OUT}	Output Voltage Swing	R _L = 1kΩ to GND	±3.5	±3.9		V
		R _L = 150Ω to GND	±3.4	±3.7		V
I _{OUT}	Output Current	A _V = 1, R _L = 10Ω to 0V	±80	±150		mA
V _{CE-ON}	\overline{CE} Pin Voltage for Power-up		(V _{S+})-5		(V _{S+})-3	V
V _{CE-OFF}	\overline{CE} Pin Voltage for Shut-down		(V _{S+})-1		V _{S+}	V
I _{EN-ON}	Pin Current - Enabled	\overline{CE} = 0V	-1	0	+1	μA
I _{EN-OFF}	Pin Current - Disabled	\overline{CE} = +5V	1	14	25	μA

EL5102, EL5103, EL5202, EL5203, EL5302

Closed Loop AC Electrical Specifications $V_{S+} = +5V$, $V_{S-} = -5V$, $T_A = 25^\circ C$, $V_{ENABLE} = +5V$, $A_V = +1$, $R_F = 0\Omega$, $R_L = 150\Omega$ to GND pin, unless otherwise specified. (Note 1)

PARAMETER	DESCRIPTION	CONDITIONS	MIN	TYP	MAX	UNIT
BW	-3dB Bandwidth ($V_{OUT} = 400mV_{P-P}$)	$A_V = 1$, $R_F = 0\Omega$		400		MHz
SR	Slew Rate	$A_V = +2$, $R_L = 100\Omega$, $V_{OUT} = -3V$ to $+3V$	1100	2200	5000	V/ μs
		$R_L = 500\Omega$, $V_{OUT} = -3V$ to $+3V$		4000		V/ μs
t_R, t_F	Rise Time, Fall Time	$\pm 0.1V$ step		2.8		ns
OS	Overshoot	$\pm 0.1V$ step		10		%
t_S	0.1% Settling Time	$V_S = \pm 5V$, $R_L = 500\Omega$, $A_V = 1$, $V_{OUT} = \pm 3V$		20		ns
dG	Differential Gain (Note 2)	$A_V = 2$, $R_F = 1k\Omega$		0.01		%
dP	Differential Phase (Note 2)	$A_V = 2$, $R_F = 1k\Omega$		0.01		$^\circ$
e_N	Input Noise Voltage	$f = 10kHz$		6		nV/ \sqrt{Hz}
i_N	Input Noise Current	$f = 10kHz$		1.25		pA/ \sqrt{Hz}
t_{DIS}	Disable Time (Note 3)			50		ns
t_{EN}	Enable Time (Note 3)			25		ns

NOTES:

- All AC tests are performed on a "warmed up" part, except slew rate, which is pulse tested.
- Standard NTSC signal = 286mV_{P-P}, $f = 3.58MHz$, as V_{IN} is swept from 0.6V to 1.314V. R_L is DC coupled.
- Disable/Enable time is defined as the time from when the logic signal is applied to the ENABLE pin to when the supply current has reached half its final value.

Typical Performance Curves

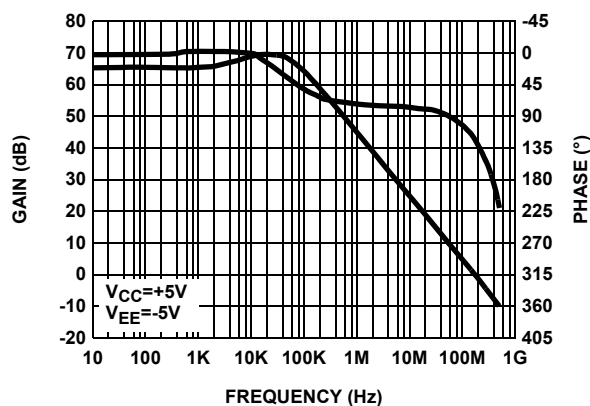

FIGURE 1. OPEN LOOP GAIN AND PHASE vs FREQUENCY

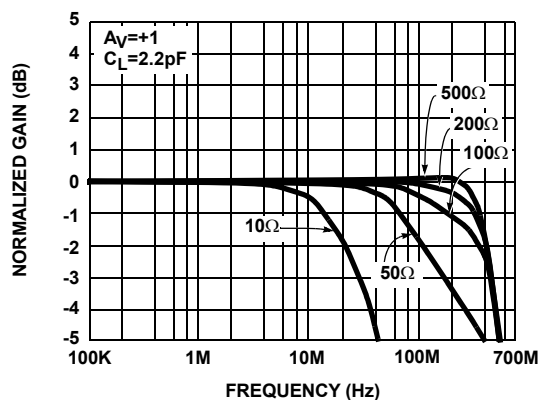

FIGURE 2. GAIN vs FREQUENCY FOR VARIOUS R_L

Typical Performance Curves (Continued)

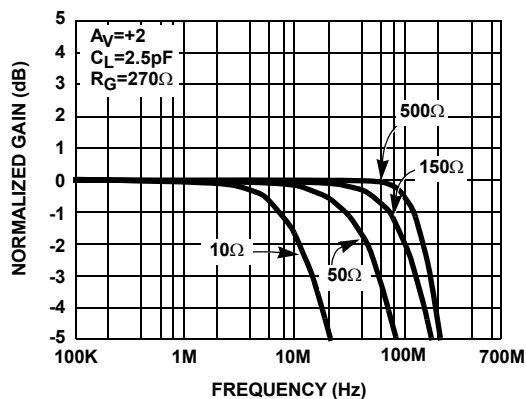

FIGURE 3. GAIN vs FREQUENCY FOR VARIOUS R_L

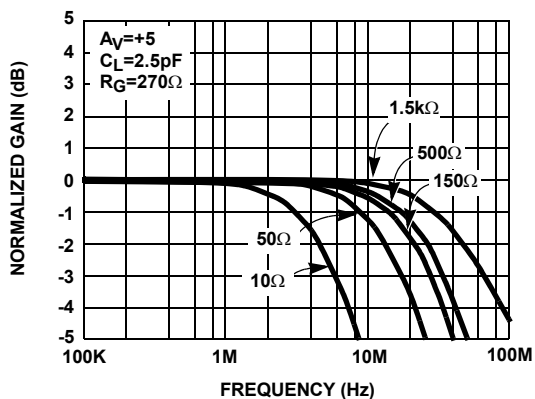

FIGURE 4. GAIN vs FREQUENCY FOR VARIOUS R_L

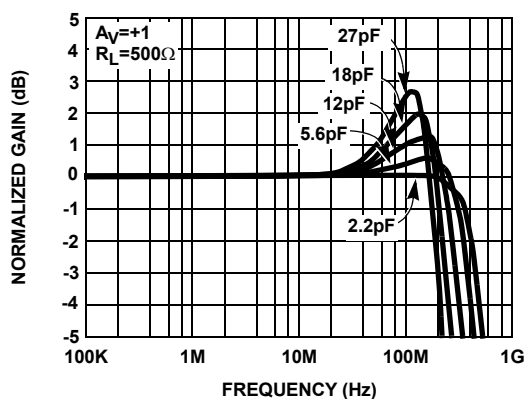

FIGURE 5. GAIN vs FREQUENCY FOR VARIOUS C_L

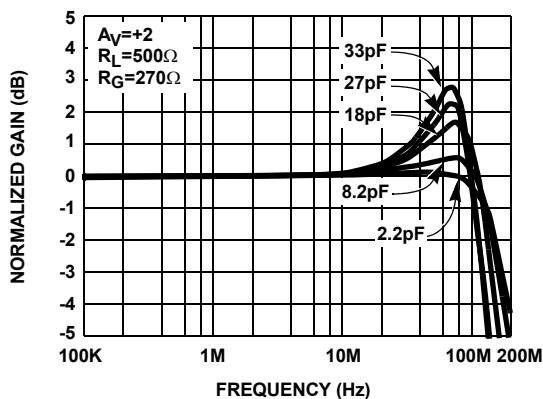

FIGURE 6. GAIN vs FREQUENCY FOR VARIOUS C_L

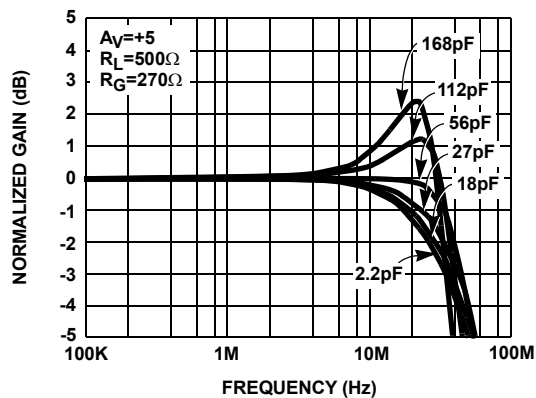

FIGURE 7. GAIN vs FREQUENCY FOR VARIOUS C_L

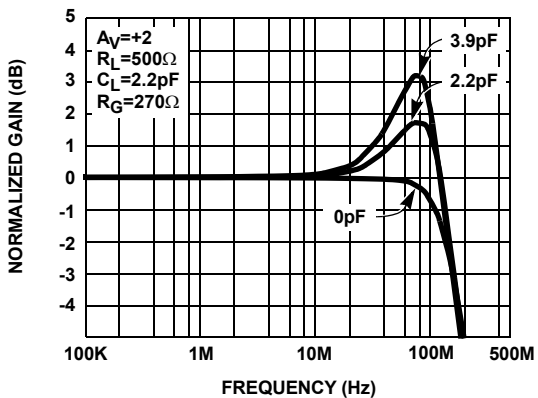

FIGURE 8. GAIN vs FREQUENCY FOR VARIOUS C_{IN}

Typical Performance Curves (Continued)

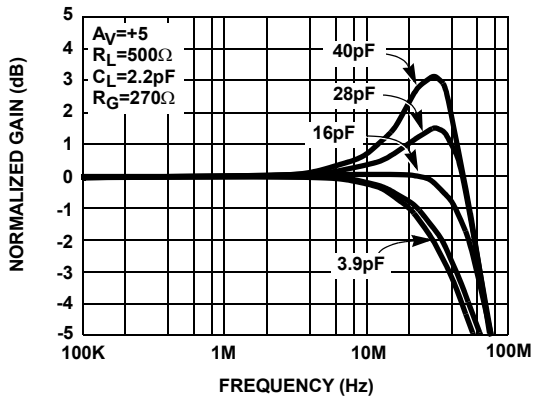

FIGURE 9. GAIN vs FREQUENCY FOR VARIOUS C_{IN}

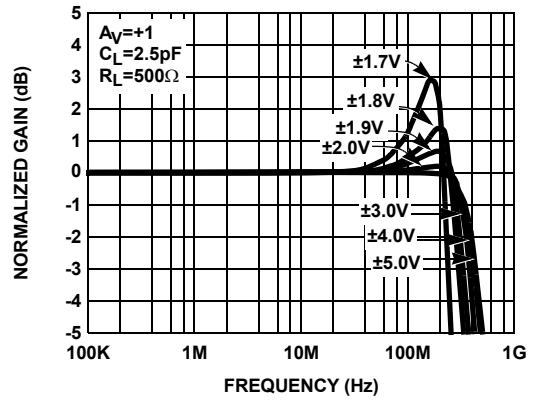

FIGURE 10. GAIN vs FREQUENCY FOR VARIOUS SUPPLY VOLTAGES

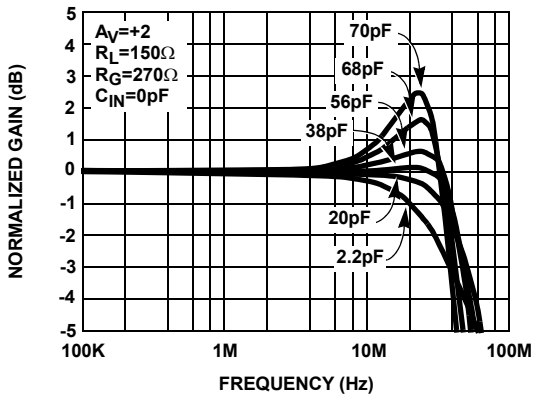

FIGURE 11. FREQUENCY vs GAIN FOR VARIOUS C_L

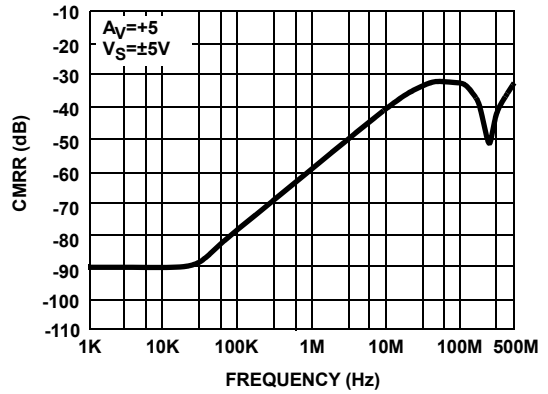

FIGURE 12. CMRR vs FREQUENCY

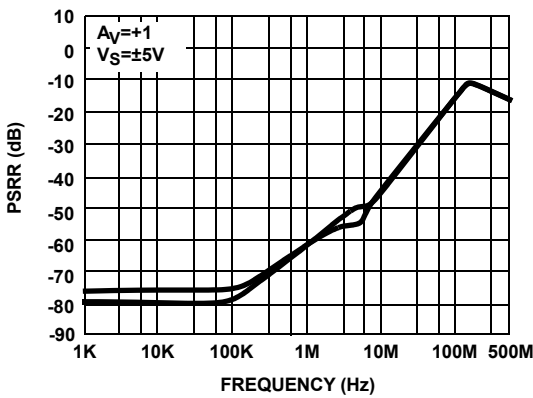

FIGURE 13. PSRR vs FREQUENCY

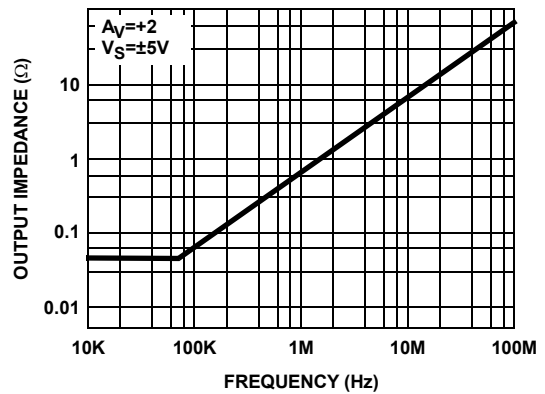

FIGURE 14. OUTPUT IMPEDANCE/PHASE vs FREQUENCY

Typical Performance Curves (Continued)

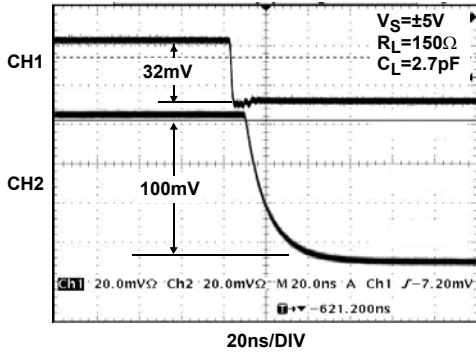

FIGURE 15. FALL TIME SMALL SIGNAL

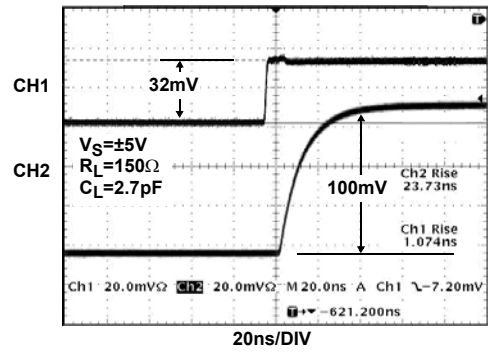

FIGURE 16. RISE TIME SMALL SIGNAL

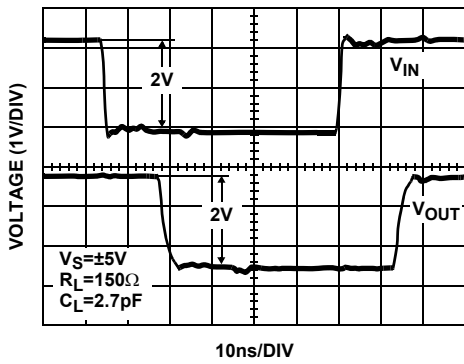

FIGURE 17. RISE AND FALL TIME LARGE SIGNAL

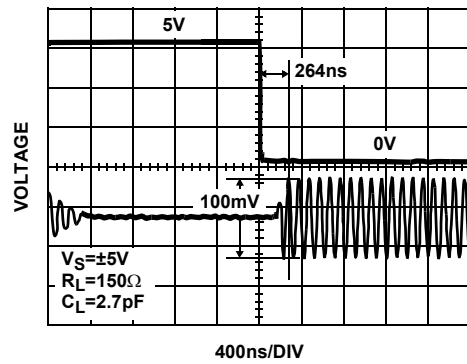

FIGURE 18. TURN-ON TIME

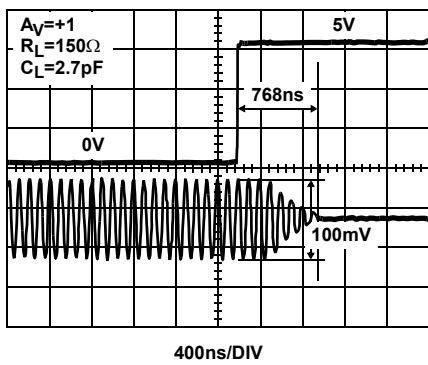

FIGURE 19. TURN-OFF TIME

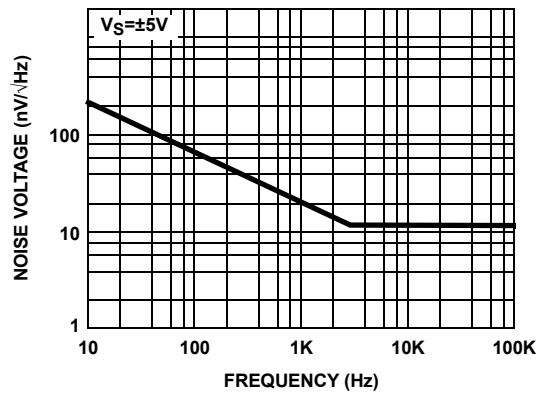

FIGURE 20. EQUIVALENT NOISE VOLTAGE vs FREQUENCY

EL5102, EL5103, EL5202, EL5203, EL5302

Typical Performance Curves (Continued)

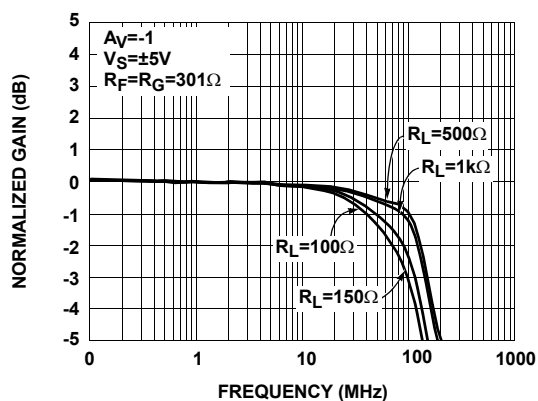

FIGURE 21. GAIN vs FREQUENCY FOR VARIOUS R_L

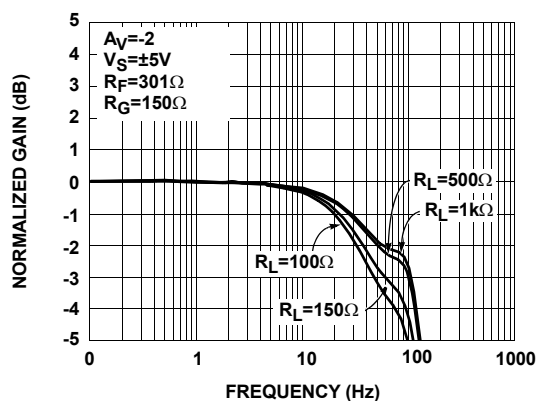

FIGURE 22. GAIN vs FREQUENCY FOR VARIOUS R_L

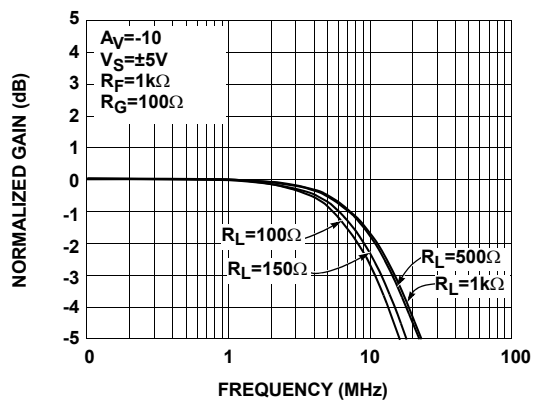

FIGURE 23. GAIN vs FREQUENCY FOR VARIOUS R_L

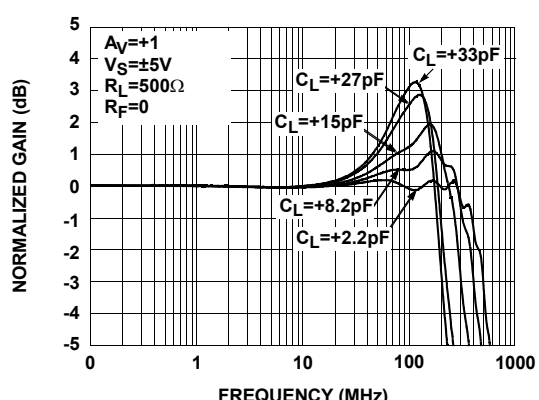

FIGURE 24. GAIN vs FREQUENCY FOR VARIOUS C_L

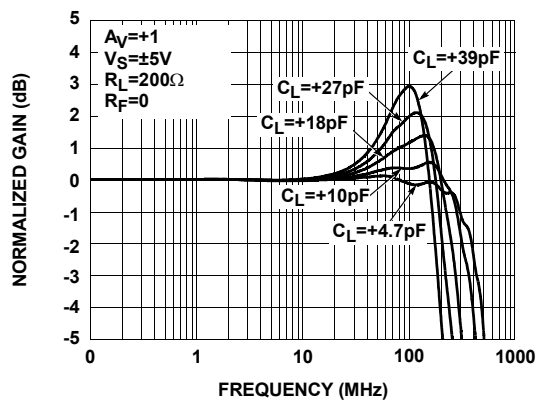

FIGURE 25. GAIN vs FREQUENCY FOR VARIOUS C_L

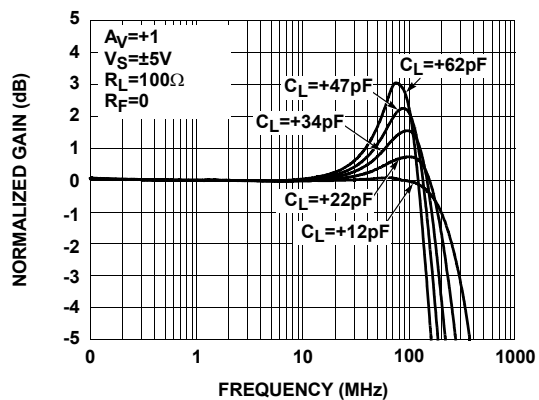

FIGURE 26. GAIN vs FREQUENCY FOR VARIOUS C_L

Typical Performance Curves (Continued)

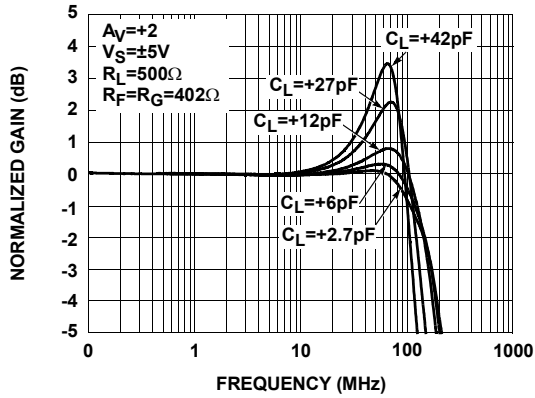

FIGURE 27. GAIN vs FREQUENCY FOR VARIOUS C_L

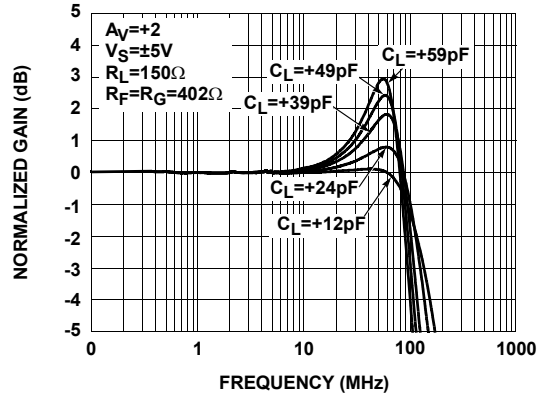

FIGURE 28. GAIN vs FREQUENCY FOR VARIOUS C_L

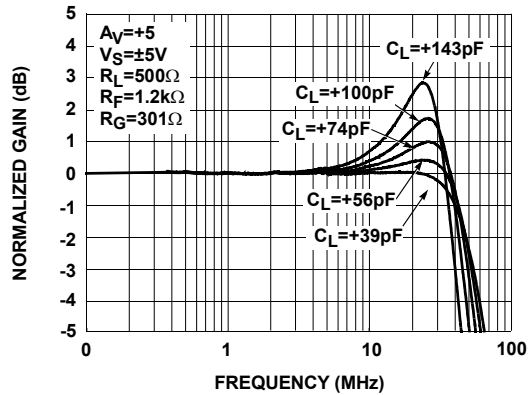

FIGURE 29. GAIN vs FREQUENCY FOR VARIOUS C_L

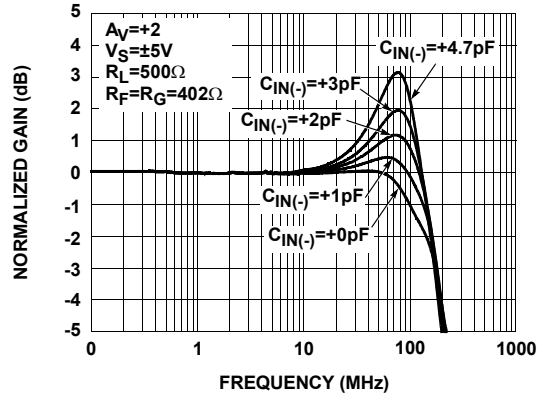

FIGURE 30. GAIN vs FREQUENCY FOR VARIOUS $C_{IN(-)}$

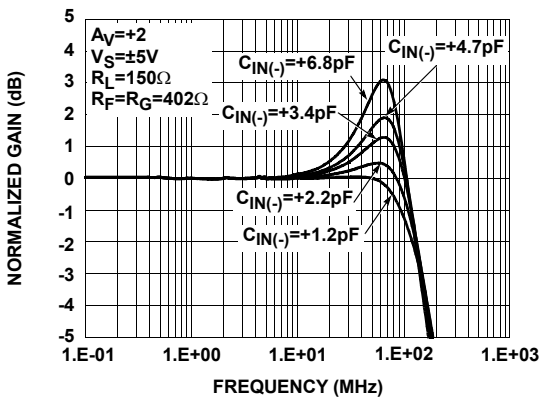

FIGURE 31. GAIN vs FREQUENCY FOR VARIOUS $C_{IN(-)}$

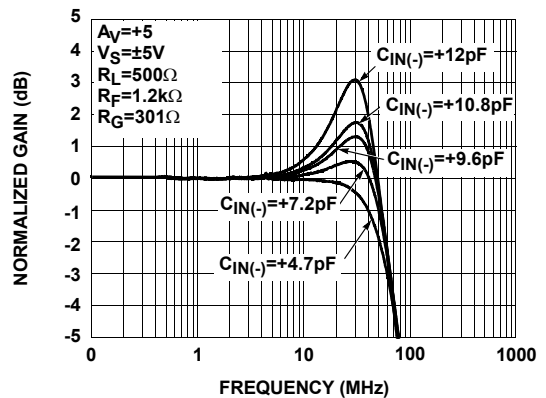

FIGURE 32. GAIN vs FREQUENCY FOR VARIOUS $C_{IN(-)}$

Typical Performance Curves (Continued)

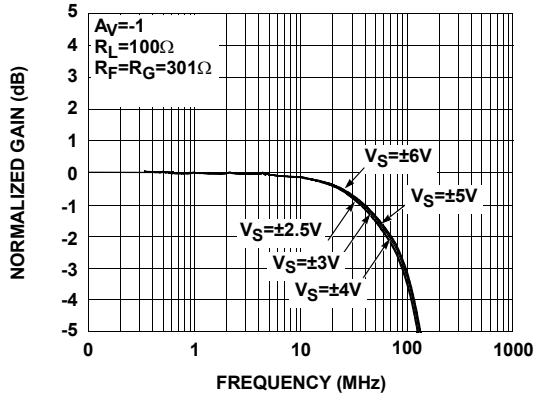

FIGURE 33. GAIN vs FREQUENCY FOR VARIOUS V_S

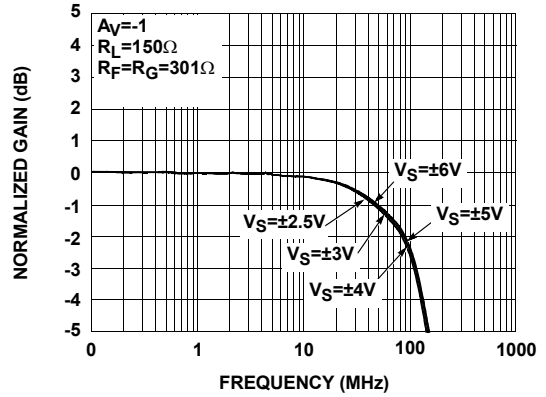

FIGURE 34. GAIN vs FREQUENCY FOR VARIOUS V_S

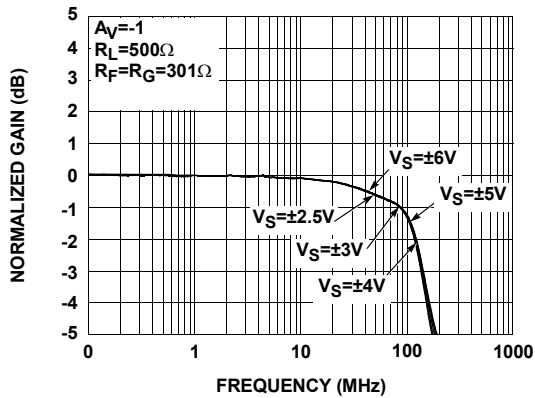

FIGURE 35. GAIN vs FREQUENCY FOR VARIOUS V_S

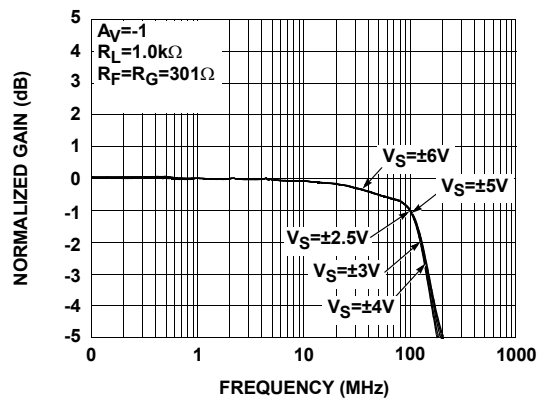

FIGURE 36. GAIN vs FREQUENCY FOR VARIOUS V_S

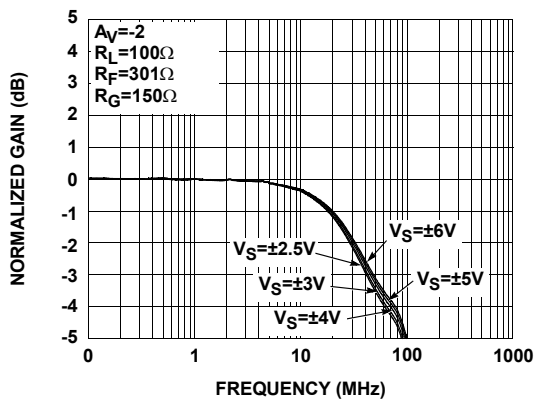

FIGURE 37. GAIN vs FREQUENCY FOR VARIOUS V_S

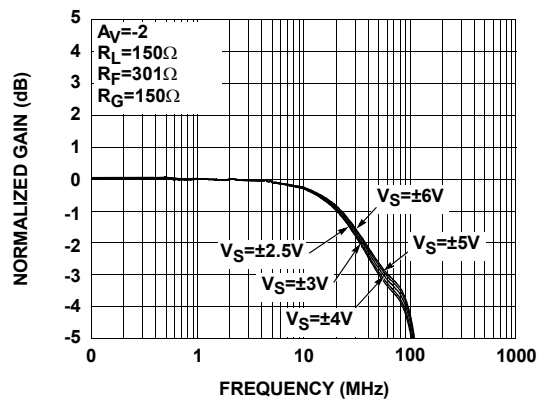

FIGURE 38. GAIN vs FREQUENCY FOR VARIOUS V_S

Typical Performance Curves (Continued)

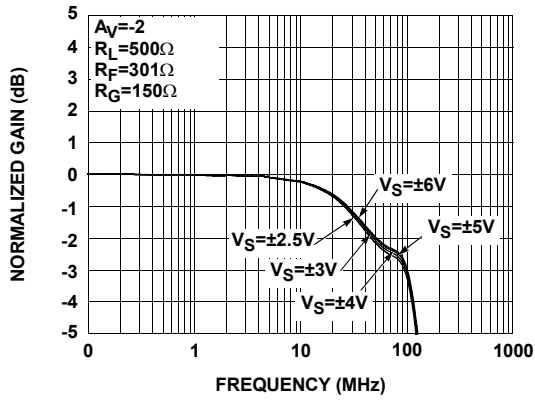

FIGURE 39. GAIN vs FREQUENCY FOR VARIOUS V_S

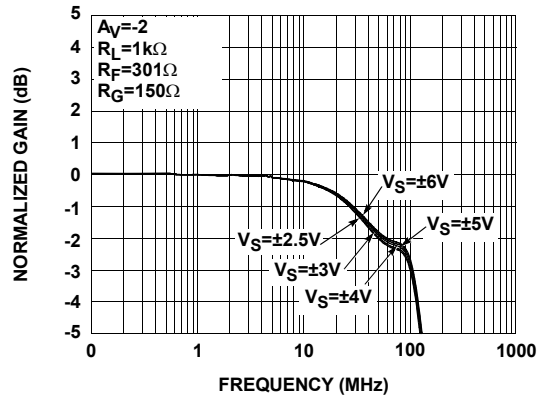

FIGURE 40. GAIN vs FREQUENCY FOR VARIOUS V_S

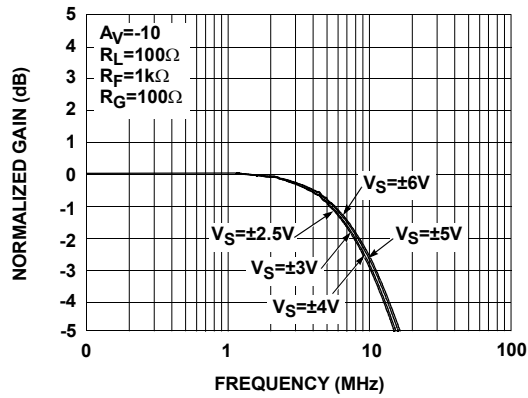

FIGURE 41. GAIN vs FREQUENCY FOR VARIOUS V_S

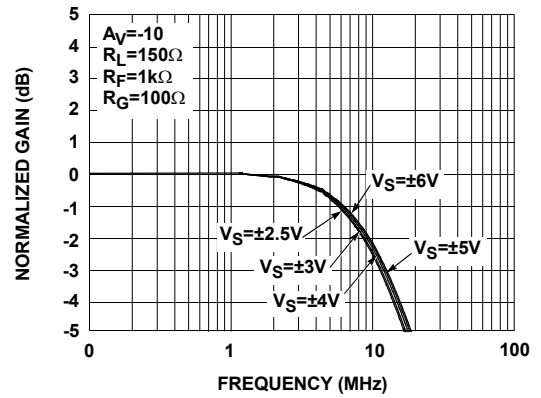

FIGURE 42. GAIN vs FREQUENCY FOR VARIOUS V_S

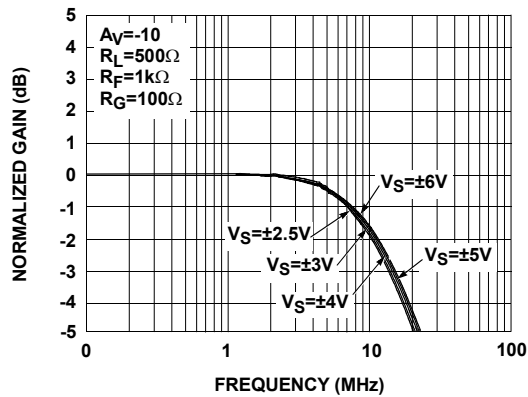

FIGURE 43. GAIN vs FREQUENCY FOR VARIOUS V_S

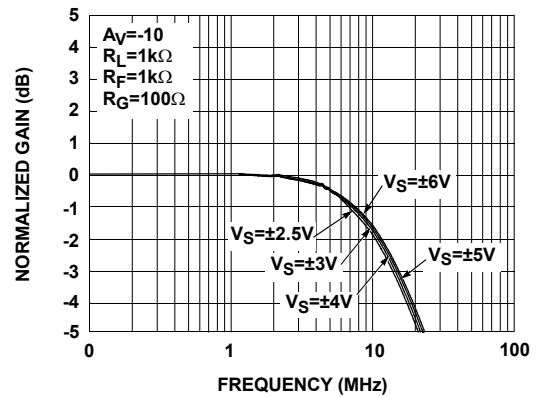

FIGURE 44. GAIN vs FREQUENCY FOR VARIOUS V_S

Typical Performance Curves (Continued)

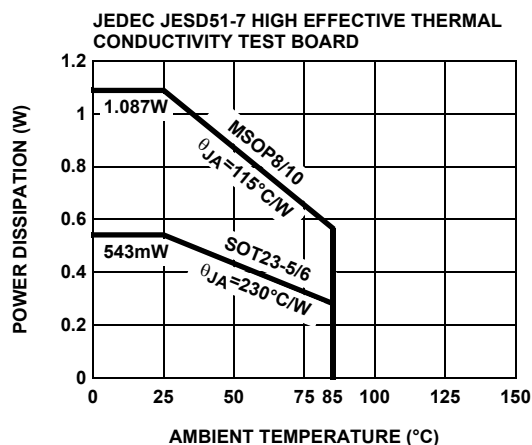

FIGURE 45. PACKAGE POWER DISSIPATION vs AMBIENT TEMPERATURE

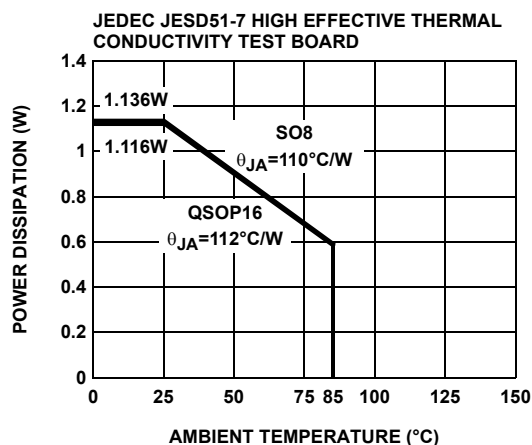

FIGURE 46. PACKAGE POWER DISSIPATION vs AMBIENT TEMPERATURE

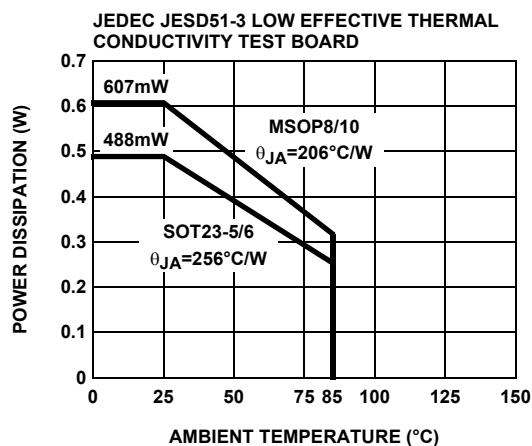

FIGURE 47. PACKAGE POWER DISSIPATION vs AMBIENT TEMPERATURE

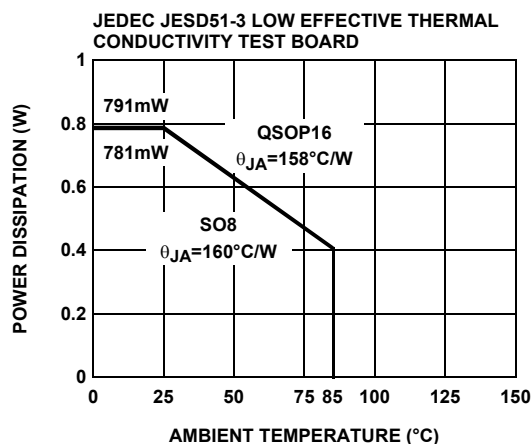

FIGURE 48. PACKAGE POWER DISSIPATION vs AMBIENT TEMPERATURE

All Intersil U.S. products are manufactured, assembled and tested utilizing ISO9000 quality systems. Intersil Corporation's quality certifications can be viewed at www.intersil.com/design/quality

Intersil products are sold by description only. Intersil Corporation reserves the right to make changes in circuit design, software and/or specifications at any time without notice. Accordingly, the reader is cautioned to verify that data sheets are current before placing orders. Information furnished by Intersil is believed to be accurate and reliable. However, no responsibility is assumed by Intersil or its subsidiaries for its use; nor for any infringements of patents or other rights of third parties which may result from its use. No license is granted by implication or otherwise under any patent or patent rights of Intersil or its subsidiaries.

For information regarding Intersil Corporation and its products, see www.intersil.com