

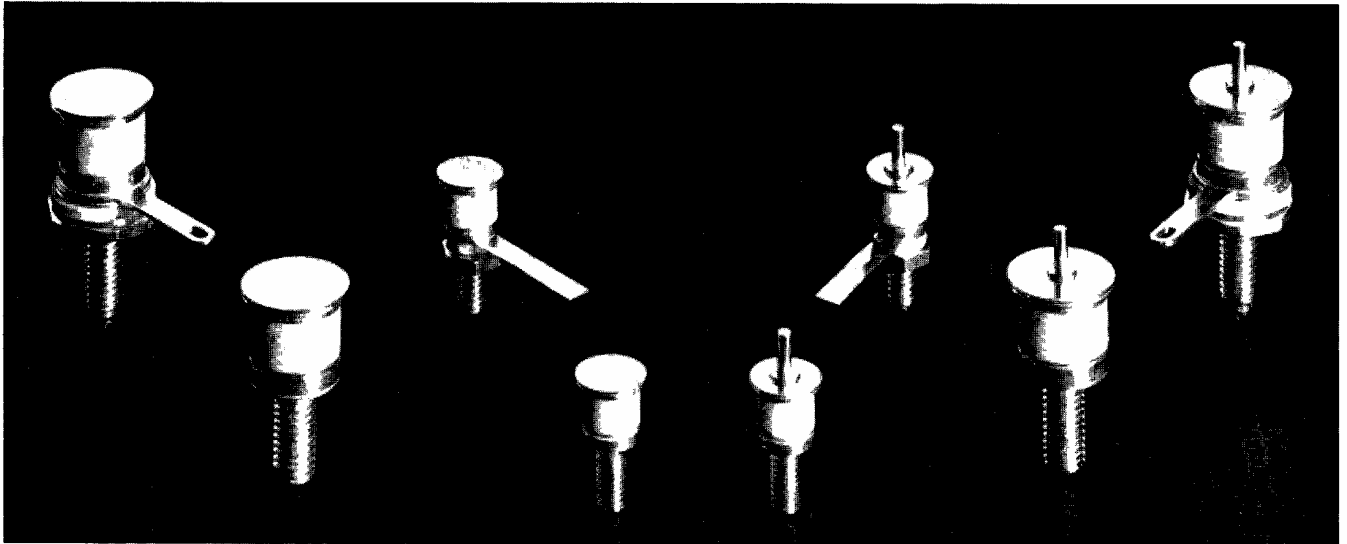

KILOVOLT™ PIN Diodes

2000 Volt and 3000 Volt PIN Diodes

MA4PK2000 and MA4PK3000 Series



Features

- Voltage Ratings to 3000 Volts
- 25 Ampere Current Rating
- Designed for HF, Multi-Kilowatt Switches
- Low Loss, Low Distortion Design
- Rugged, Hermetically Sealed Packaging
- Convenient Solder Lug Attachment

Description

M/A-COM's KILOVOLT™ PIN diodes utilize modern semiconductor and packaging technology that assures low loss, low distortion, and reliable performance in multi-kilowatt switch applications at frequencies as low as 1 MHz. The semiconductor chips employed have low resistance, high power dissipation and very high stand-off voltage capability.

KILOVOLT™ PIN diodes employ ultra high resistivity, long carrier lifetime, float zone silicon intrinsic material onto which P+ and N+ regions are deposited using an epitaxial process specifically designed at M/A-COM for high voltage PIN diodes. This process results in better preservation of the intrinsic carrier lifetime and superior junctions in comparison to the conventional double diffused process. The processing of the I-region width is tightly controlled using modern lapping techniques.

KILOVOLT™ PIN diode chips utilize M/A-COM's proprietary cermachip™ glass passivation. The hard glass covers all exposed junction and intrinsic region surfaces. This results in a hermetically sealed, passivated chip that has been accepted in many hi-rel military programs.

Packaging

New metal-ceramic packages were developed for the KILOVOLT™ PIN diode series. They were designed to withstand extremely high voltages and currents and to be compatible with the semiconductor chip and RF circuitry. These packages meet the environmental requirements of MIL-STD-202 and MIL-STD-750.

The PIN diode chip is bonded to the package and the anode strap is bonded to the chip at temperatures exceeding 300°C. The anode strap is a unique, large cross-section area design allowing for high current capability. The packages are sealed using a projection welding technique in an inert environment.

KILOVOLT™ PIN diodes are available with a solder lug on the anode electrode to allow a convenient and reliable wrap-around wire connection. ALL 2000 VOLT DIODES ARE IN NON-MAGNETIC PACKAGES.

Applications

M/A-COM's KILOVOLT™ PIN diodes are designed for use as high power switching elements in multi-kilowatt HF and VHF applications. These PIN diodes have been extensively characterized for their electrical and thermal properties to assure predictable low loss, high power handling, and low distortion performance. Some typical applications are as follows:

1. Filter Switches
2. Antenna Couplers
3. Power Amplifier By-pass Switches
4. MRI Switches

Bulletin No. 4335

KILOVOLT PIN Diodes — MA4PK2000 and MA4PK3000 Series

M/A-COM KILOVOLT PIN Diodes

Part Numbers

| 2000 Volt Rating | 3000 Volt Rating | Package Type |
|------------------|------------------|--------------------------------|
| MA4PK2000 | MA4PK3000 | Pill |
| MA4PK2001 | MA4PK3001 | Stud - Solder Lug |
| MA4PK2002 | MA4PK3002 | Stud - No Solder Lug |
| MA4PK2003 | MA4PK3003 | Insulated Stud - Solder Lug |
| MA4PK2004 | MA4PK3004 | Insulated Stud - No Solder Lug |

Maximum Ratings

| | |
|--|-------------------|
| Operating and Storage Temperature | -65°C to +175°C |
| Installation Temperature | 250°C, 30 Seconds |
| Instantaneous Reverse Voltage | Voltage Rating |
| Forward Current (RF and DC) | 25 Amperes |
| Power Dissipation at 25°C Case Temperature | |
| MA4PK2001, MA4PK2002 | 50 Watts |
| MA4PK2003, MA4PK2004 | 37.5 Watts |
| MA4PK3001, MA4PK3002 | 75 Watts |
| MA4PK3003, MA4PK3004 | 50 Watts |

Note: Cathode heat sink is standard on all parts. Reverse polarity, NIP diodes are available on request.

Electrical Specifications @ 25°C

| Parameter | Condition | MA4PK2000 Series | MA4PK3000 Series |
|--------------------------------|------------------------------|-----------------------------------|-----------------------------------|
| Reverse Voltage Rating | 10 μ A | 2000 Volts | 3000 Volts |
| Series Resistance (Max) | F = 4 MHz, I = 0.5 A | 0.20 Ω | 0.25 Ω |
| Series Resistance (Typ) | F = 1.0 - 100 MHz, I = 0.5 A | 0.10 Ω | 0.15 Ω |
| Total Capacitance (Max) | F = 1 MHz, V = 100 V | 3.2 pF | 4.0 pF |
| Reverse Bias Conductance (Max) | F = 10 MHz, V = 100 V | 1 μ S | 1 μ S |
| Carrier Lifetime (Min) | I _F = 10 mA | 10 μ s | 20 μ s |
| Forward Voltage (Max) | I _F = 1 A | 1.2 V | 1.2 V |
| Thermal Resistance (Max) | | 3°C/W (Stud) 4°C/W (Ins. Stud) | 2°C/W (Stud) 3°C/W (Ins. Stud) |
| I-Region Width (Nom) | | 200 μ m | 325 μ m |

MA4PK2000
MA4PK3000



MA4PK2001
MA4PK3001

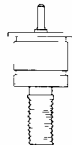

MA4PK2002
MA4PK3002

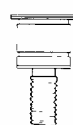

MA4PK2003
MA4PK3003

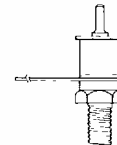

MA4PK2004
MA4PK3004

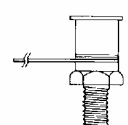

Typical Characteristics

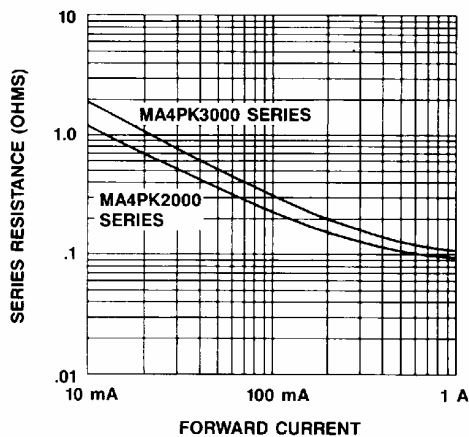

FIGURE 1. SERIES RESISTANCE VS. CURRENT
FREQUENCY 1 - 100 MHz

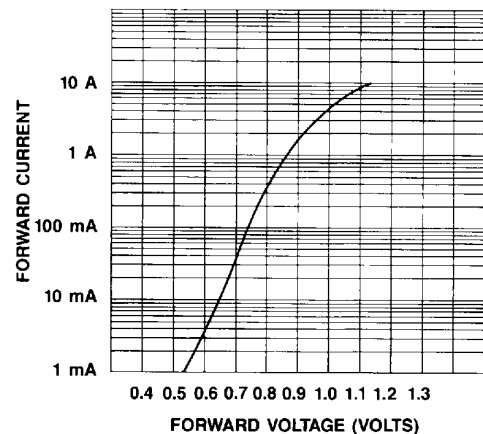

FIGURE 2. DC FORWARD VOLTAGE VS. FORWARD CURRENT
MA4PK2000 SERIES AND MA4PK3000 SERIES

Typical Characteristics (Cont'd)

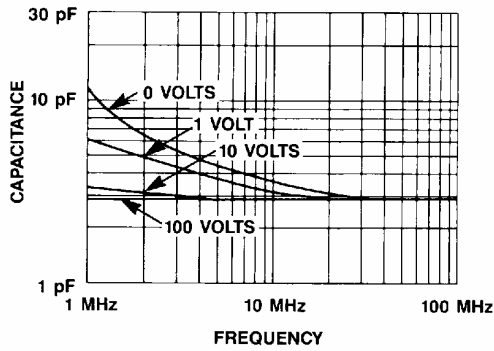

FIGURE 3. REVERSE BIAS CAPACITANCE VS. FREQUENCY AND REVERSE VOLTAGE - MA4PK2000 SERIES

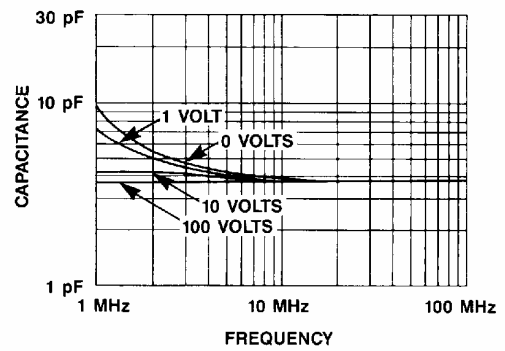

FIGURE 4. REVERSE BIAS CAPACITANCE VS. FREQUENCY AND REVERSE VOLTAGE - MA4PK3000 SERIES

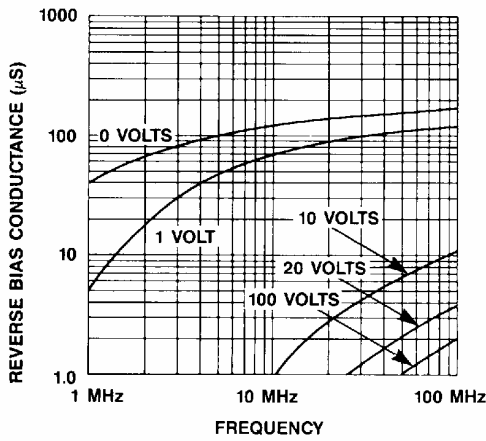

FIGURE 5. REVERSE BIAS CONDUCTANCE VS. FREQUENCY AND REVERSE VOLTAGE - MA4PK2000 SERIES

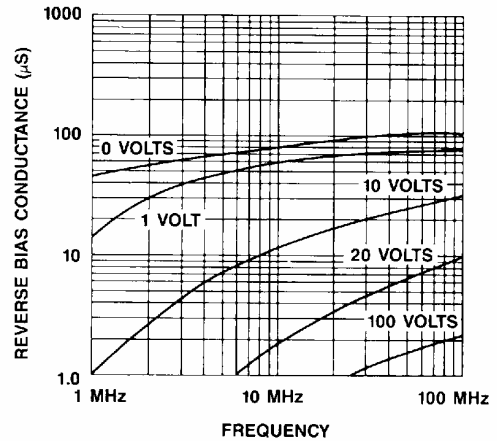

FIGURE 6. REVERSE BIAS CONDUCTANCE VS. FREQUENCY AND REVERSE VOLTAGE - MA4PK3000 SERIES

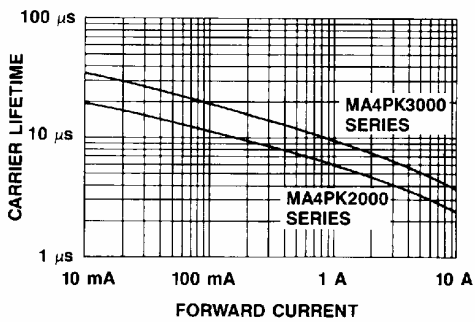

FIGURE 7. CARRIER LIFETIME VS. FORWARD CURRENT

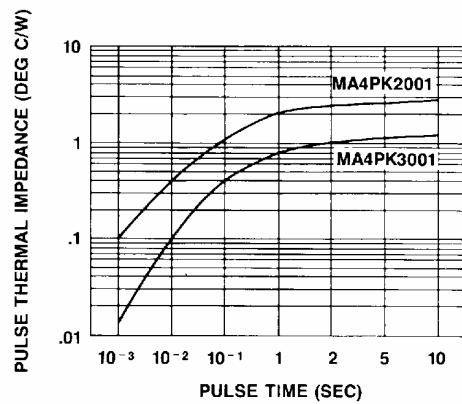
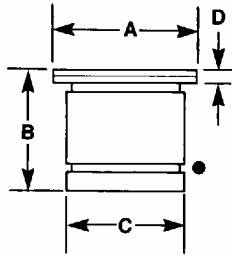

FIGURE 8. PULSED THERMAL RESISTANCE

Case Styles*

● DENOTES CATHODE

Pill



MA4PK2000
ODS-1027

| DIM. | INCHES | | MILLIMETERS | |
|------|--------|------|-------------|------|
| | MIN. | MAX. | MIN. | MAX. |
| A | 304 | 316 | 7.72 | 8.02 |
| B | 254 | 270 | 6.45 | 6.86 |
| C | 245 | 255 | 6.22 | 6.48 |
| D | 023 | 031 | 0.58 | 0.79 |

$C_P = .45 \text{ pF}$
 $L_S = 2 \text{ nH}$

MAPK3000
ODS-1073

| DIM. | INCHES | | MILLIMETERS | |
|------|--------|------|-------------|------|
| | MIN. | MAX. | MIN. | MAX. |
| A | 468 | 485 | 11.9 | 12.3 |
| B | 373 | 395 | 9.45 | 10.0 |
| C | 390 | 400 | 9.91 | 10.2 |
| D | 028 | 042 | 0.71 | 1.06 |

$C_P = .75 \text{ pF}$
 $L_S = 3 \text{ nH}$

Stud

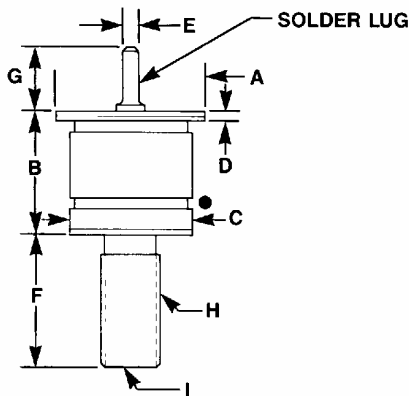

MA4PK2001
ODS-1082
(Solder Lug)

| DIM. | INCHES | | MILLIMETERS | |
|------|---------------------|------|-------------|------|
| | MIN. | MAX. | MIN. | MAX. |
| A | 304 | 316 | 7.72 | 8.02 |
| B | 266 | 292 | 6.45 | 6.86 |
| C | 245 | 255 | 6.22 | 6.48 |
| D | 023 | 031 | 0.58 | 0.79 |
| E | 060 | 065 | 1.52 | 1.65 |
| F | 281 | 305 | 7.14 | 7.75 |
| G | 190 | 205 | 4.83 | 5.21 |
| H | 6-40 UNF 3A | | | |
| I | 072 SPLINE x .07 DP | | | |

$C_P = .45 \text{ pF}$
 $L_S = 2 \text{ nH}$

MA4PK2002
ODS-1048
(No Solder Lug)

MA4PK3001
ODS-1084
(Solder Lug)

| DIM. | INCHES | | MILLIMETERS | |
|------|-------------------|------|-------------|------|
| | MIN. | MAX. | MIN. | MAX. |
| A | 468 | 485 | 11.9 | 12.3 |
| B | 387 | 411 | 9.83 | 10.4 |
| C | 390 | 400 | 9.90 | 10.1 |
| D | 028 | 042 | 0.71 | 1.06 |
| E | 060 | 065 | 1.52 | 1.65 |
| F | 425 | 445 | 10.8 | 11.3 |
| G | 190 | 205 | 4.83 | 5.21 |
| H | 10-32 UNF-2A | | | |
| I | 050 SLOT x .06 DP | | | |

$C_P = .75 \text{ pF}$
 $L_S = 3 \text{ nH}$

Insulated Stud

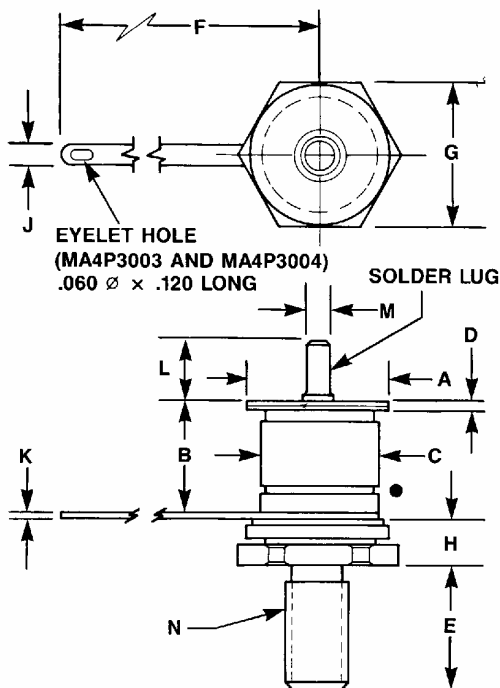

MA4PK2003
ODS-1080
(Solder Lug)

| DIM. | INCHES | | MILLIMETERS | |
|------|-------------|------|-------------|------|
| | MIN. | MAX. | MIN. | MAX. |
| A | 304 | 316 | 7.72 | 8.02 |
| B | 254 | 270 | 6.45 | 6.86 |
| C | 245 | 255 | 6.22 | 6.48 |
| D | 023 | 031 | 0.58 | 0.79 |
| E | 221 | 252 | 5.61 | 6.40 |
| F | 780 | 790 | 19.8 | 20.1 |
| G | 245 | 255 | 6.22 | 6.48 |
| H | 128 | 137 | 3.25 | 3.48 |
| J | 120 | 130 | 3.05 | 3.30 |
| K | 007 | 009 | 0.18 | 0.23 |
| L | 190 | 205 | 4.83 | 5.21 |
| M | 060 | 065 | 1.52 | 1.65 |
| N | 6-32 UNC-3A | | | |

$C_P = .45 \text{ pF}$
 $L_S = 2 \text{ nH}$
 $C_{GRD} = 1.1 \text{ pF}$

MA4PK2004
ODS-1038
(No Solder Lug)

MA4PK3003
ODS-1085
(Solder Lug)

| DIM. | INCHES | | MILLIMETERS | |
|------|--------------|------|-------------|-------|
| | MIN. | MAX. | MIN. | MAX. |
| A | 468 | 485 | 11.9 | 12.3 |
| B | 373 | 395 | 9.47 | 10.0 |
| C | 390 | 400 | 9.91 | 10.2 |
| D | 028 | 042 | 0.71 | 1.07 |
| E | 422 | 452 | 10.7 | 11.5 |
| F | 805 | 820 | 20.4 | 20.8 |
| G | 490 | 500 | 12.4 | 12.7 |
| H | 148 | 170 | 3.76 | 4.32 |
| J | 120 | 130 | 3.05 | 3.30 |
| K | 022 | 026 | 0.559 | 0.660 |
| L | 190 | 205 | 4.83 | 5.21 |
| M | 060 | 065 | 1.52 | 1.65 |
| N | 10-32 UNF-2A | | | |

$C_P = .75 \text{ pF}$
 $L_S = 3 \text{ nH}$
 $C_{GRD} = 4.2 \text{ pF}$

*For drop-in replacements of select competitor packages, please consult the factory.

M/A-COM SEMICONDUCTOR DIVISION • Burlington, MA 01803 • (617) 272-3000 • FAX (617) 272-8861

Copyright Each Manufacturing Company.

All Datasheets cannot be modified without permission.

This datasheet has been download from :

www.AllDataSheet.com

100% Free DataSheet Search Site.

Free Download.

No Register.

Fast Search System.

www.AllDataSheet.com