



Schottky Barrier Diodes for General Purpose Applications

Technical Data

1N5711
1N5712
5082-2300 Series
5082-2800 Series
5082-2900

Features

- **Low Turn-On Voltage**
As Low as 0.34 V at 1 mA
- **Pico Second Switching Speed**
- **High Breakdown Voltage**
Up to 70 V
- **Matched Characteristics Available**

Description/Applications

The 1N5711, 1N5712, 5082-2800/10/11 are passivated Schottky barrier diodes which use a patented "guard ring" design to achieve a high breakdown voltage. Packaged in a low cost glass package, they are well suited for high level detecting, mixing, switching, gating, log or A-D converting, video detecting, frequency discriminating, sampling, and wave shaping.

The 5082-2835 is a passivated Schottky diode in a low cost glass package. It is optimized for low turn-on voltage. The 5082-2835 is particularly well suited for the UHF mixing needs of the CATV marketplace.

The 5082-2300 Series and 5082-2900 devices are unpassivated Schottky diodes in a glass package. These diodes have extremely low 1/f noise and are ideal for low noise mixing, and high sensitivity detecting. They are particularly well suited for use in Doppler or narrow band video receivers.

Outline 15

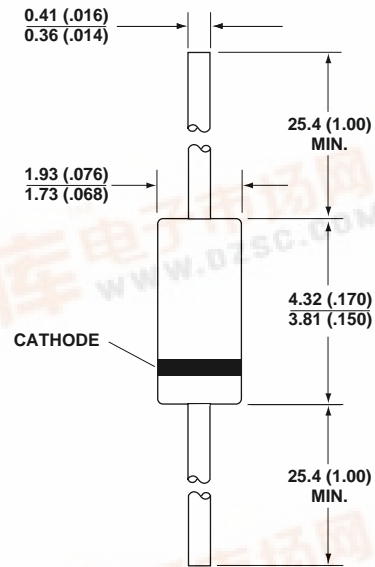

DIMENSIONS IN MILLIMETERS AND (INCHES).

Maximum Ratings

Junction Operating and Storage Temperature Range

5082-2303, -2900	-60°C to +100°C
1N5711, 1N5712, 5082-2800/10/11	-65°C to +200°C
5082-2835	-60°C to +150°C

DC Power Dissipation

(Measured in an infinite heat sink at $T_{CASE} = 25^{\circ}C$)

Derate linearly to zero at maximum rated temperature

5082-2303, -2900	100 mW
1N5711, 1N5712, 5082-2800/10/11	250 mW
5082-2835	150 mW

Peak Inverse Voltage V_{BR}



Package Characteristics

Outline 15

Lead Material	Dumet
Lead Finish	95-5% Tin-Lead
Max. Soldering Temperature	260°C for 5 sec
Min. Lead Strength	4 pounds pull
Typical Package Inductance	
1N5711, 1N5712:	2.0 nH
2800 Series:	2.0 nH
2300 Series, 2900:	3.0 nH
Typical Package Capacitance	
1N5711, 1N5712:	0.2 pF
2800 Series:	0.2 pF
2300 Series, 2900:	0.07 pF

The leads on the Outline 15 package should be restricted so that the bend starts at least 1/16 inch from the glass body.

Outline 15 diodes are available on tape and reel. The tape and reel specification is patterned after RS-296-D.

Electrical Specifications at $T_A = 25^\circ\text{C}$

General Purpose Diodes

Part Number	Package Outline	Min. Breakdown Voltage V_{BR} (V)	Max. Forward Voltage V_F (mV)	$V_F = 1$ V Max. at Forward Current I_F (mA)	Max. Reverse Leakage Current I_R (nA) at V_R (V)	Max. Capacitance C_T (pF)
5082-2800	15	70	410	15	200 50	2.0
1N5711	15	70	410	15	200 50	2.0
5082-2810	15	20	410	35	100 15	1.2
1N5712	15	20	550	35	150 16	1.2
5082-2811	15	15	410	20	100 8	1.2
5082-2835	15	8*	340	10*	100 1	1.0
Test Conditions		$I_R = 10 \mu\text{A}$ * $I_R = 100 \mu\text{A}$	$I_F = 1 \text{ mA}$	* $V_F = 0.45 \text{ V}$		$V_R = 0 \text{ V}$ $f = 1.0 \text{ MHz}$

Note: Effective Carrier Lifetime (τ) for all these diodes is 100 ps maximum measured with Krakauer method at 5 mA except for 5082-2835 which is measured at 20 mA.

Low 1/f (Flicker) Noise Diodes

Part Number 5082-	Package Outline	Min. Breakdown Voltage V_{BR} (V)	Max. Forward Voltage V_F (mV)	$V_F = 1$ V Max. at Forward Current I_F (mA)	Max. Reverse Leakage Current I_R (nA) at V_R (V)	Max. Capacitance C_T (pF)
2303	15	20	400	35	500 15	1.0
2900	15	10	400	20	100 5	1.2
Test Conditions		$I_R = 10 \mu\text{A}$	$I_F = 1 \text{ mA}$			$V_R = 0 \text{ V}$ $f = 1.0 \text{ MHz}$

Note: Effective Carrier Lifetime (τ) for all these diodes is 100 ps maximum measured with Krakauer method at 20 mA.

Matched Pairs and Quads

Basic Part Number 5082-	Matched Pair Unconnected	Matched Quad Unconnected	Batch Matched ^[1]	Test Conditions
2900				ΔV_F at $I_F = 1.0, 10 \text{ mA}$
2800	5082-2804 $\Delta V_F = 20 \text{ mV}$	5082-2805 $\Delta V_F = 20 \text{ mV}$		ΔV_F at $I_F = 0.5, 5 \text{ mA}$ $*I_F = 10 \text{ mA}$ ΔC_O at $f = 1.0 \text{ MHz}$
2811			5082-2826 $\Delta V_F = 10 \text{ mV}$ $\Delta C_O = 0.1 \text{ pF}$	ΔV_F at $I_F = 10 \text{ mA}$ ΔC_O at $f = 1.0 \text{ MHz}$
2835			5082-2080 $\Delta V_F = 10 \text{ mV}$ $\Delta C_O = 0.1 \text{ pF}$	ΔV_F at $I_F = 10 \text{ mA}$ ΔC_O at $f = 1.0 \text{ MHz}$

Note:

1. Batch matched devices have a minimum batch size of 50 devices.

SPICE Parameters

Parameter	Units	5082-2800	5082-2810	5082-2811	5082-2835	5082-2303	5082-2900
B_V	V	75	25	18	9	25	10
C_{J0}	pF	1.6	0.8	1.0	0.7	0.7	1.1
E_G	eV	0.69	0.69	0.69	0.69	0.69	0.69
I_{BV}	A	10E-5	10E-5	10E-5	10E-5	10E-5	10E-5
I_S	A	2.2 x 10E-9	1.1 x 10E-9	0.3 x 10E-8	2.2 x 10E-8	7 x 1.0E-9	10E-8
N		1.08	1.08	1.08	1.08	1.08	1.08
R_S	Ω	25	10	10	5	10	15
P_B	V	0.6	0.6	0.6	0.56	0.64	0.64
P_T		2	2	2	2	2	2
M		0.5	0.5	0.5	0.5	0.5	0.5

Typical Parameters

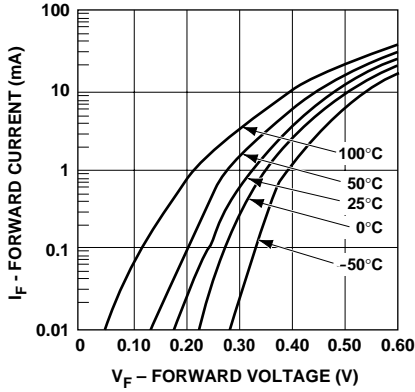

Figure 1. I-V Curve Showing Typical Temperature Variation for 5082-2300 Series and 5082-2900 Schottky Diodes.

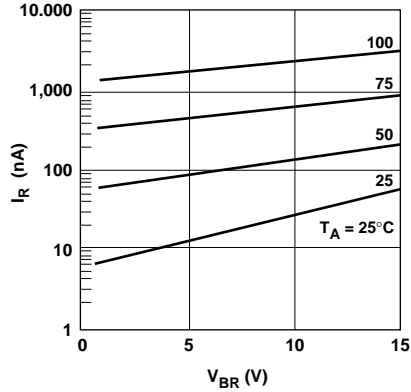

Figure 2. 5082-2300 Series Typical Reverse Current vs. Reverse Voltage at Various Temperatures.

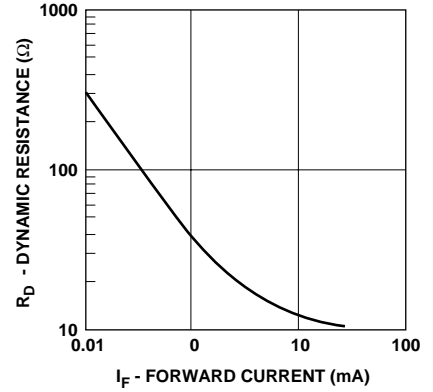

Figure 3. 5082-2300 Series and 5082-2900 Typical Dynamic Resistance (R_D) vs. Forward Current (I_F).

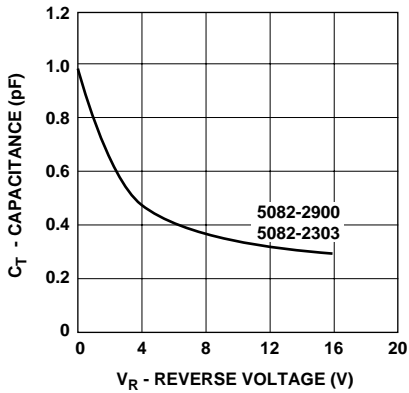

Figure 4. 5082-2300 and 5082-2900 Typical Capacitance vs. Reverse Voltage.

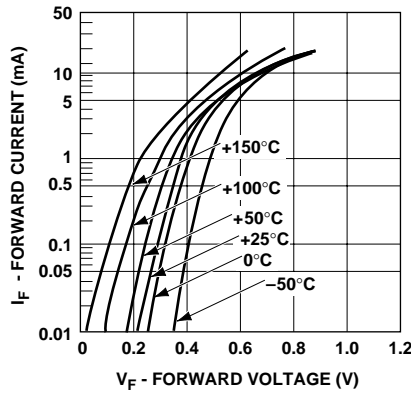

Figure 5. I-V Curve Showing Typical Temperature Variation for 5082-2800 or 1N5711 Schottky Diodes.

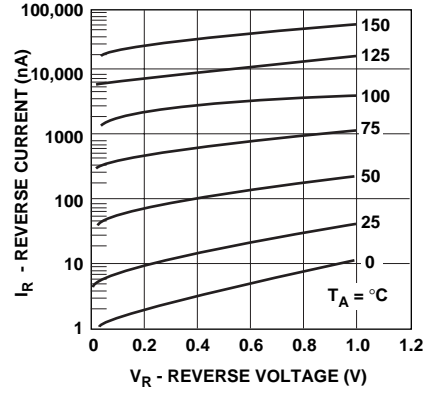

Figure 6. (5082-2800 OR 1N5711) Typical Variation of Reverse Current (I_R) vs. Reverse Voltage (V_R) at Various Temperatures.

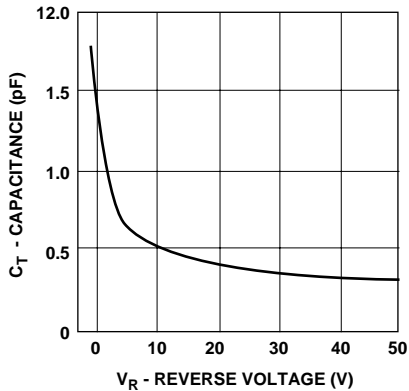

Figure 7. (5082-2800 or 1N5711) Typical Capacitance (C_T) vs. Reverse Voltage (V_R).

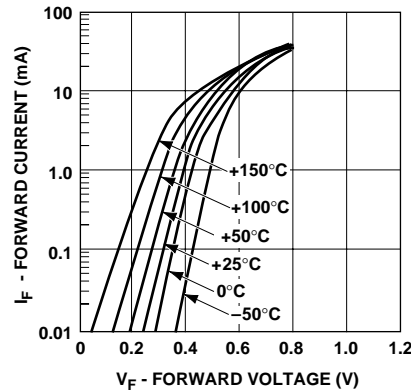

Figure 8. I-V Curve Showing Typical Temperature Variation for the 5082-2810 or 1N5712 Schottky Diode.

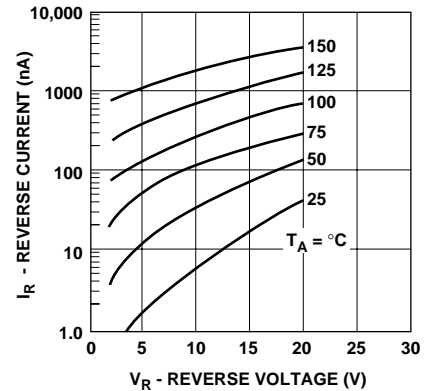

Figure 9. (5082-2810 or 1N5712) Typical Variation of Reverse Current (I_R) vs. Reverse Voltage (V_R) at Various Temperatures.

Typical Parameters, continued

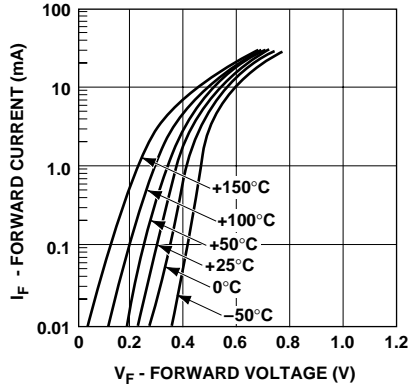

Figure 10. I-V Curve Showing Typical Temperature Variation for the 5082-2811 Schottky Diode.

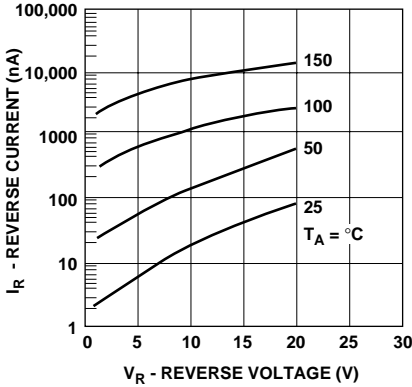

Figure 11. (5082-2811) Typical Variation of Reverse Current (I_R) vs. Reverse Voltage (V_R) at Various Temperatures.

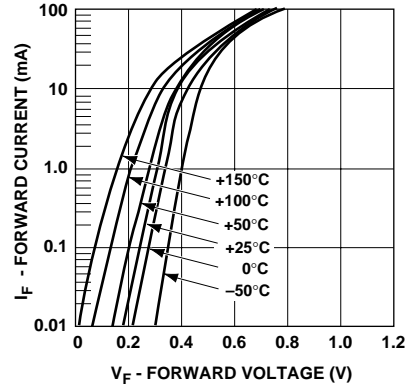

Figure 12. I-V Curve Showing Typical Temperature Variations for 5082-2835 Schottky Diode.

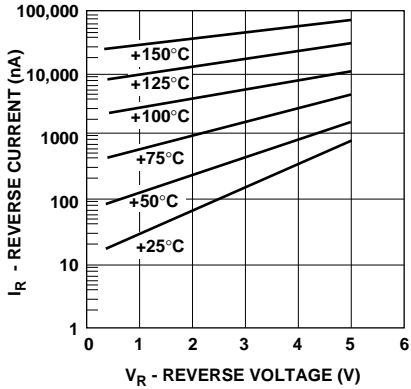

Figure 13. (5082-2835) Typical Variation of Reverse Current (I_R) vs. Reverse Voltage (V_R) at Various Temperatures.

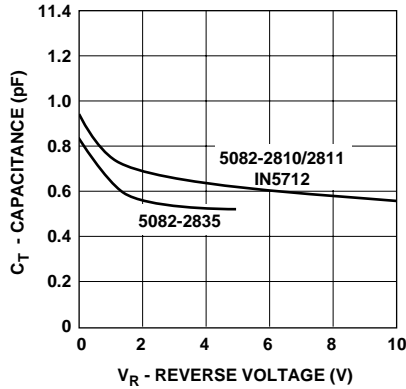

Figure 14. Typical Capacitance (C_T) vs. Reverse Voltage (V_R).

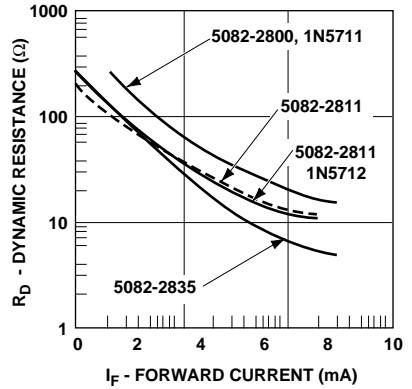

Figure 15. Typical Dynamic Resistance (R_D) vs. Forward Current (I_F).



Diode Package Marking

1N5xxx 5082-xxxx

would be marked:

1Nx	xx
xxx	xx
YWW	YWW

where xxxx are the last four digits of the 1Nxxxx or the 5082-xxxx part number. Y is the last digit of the calendar year. WW is the work week of manufacture.

Examples of diodes manufactured during workweek 45 of 1999:

1N5712 5082-3080

would be marked:

1N5	30
712	80
945	945