



TS420 Series

SENSITIVE

4A SCRs

MAIN FEATURES:

Symbol	Value	Unit
$I_{T(RMS)}$	4	A
V_{DRM}/V_{RRM}	600 and 700	V
I_{GT}	200	μA

DESCRIPTION

Thanks to highly sensitive triggering levels, the TS420 series is suitable for all applications where the available gate current is limited, such as motor control for hand tools, kitchen aids, overvoltage crowbar protection for low power supplies, ... Available in through-hole or surface-mount packages, they provide an optimized performance in a limited space area.

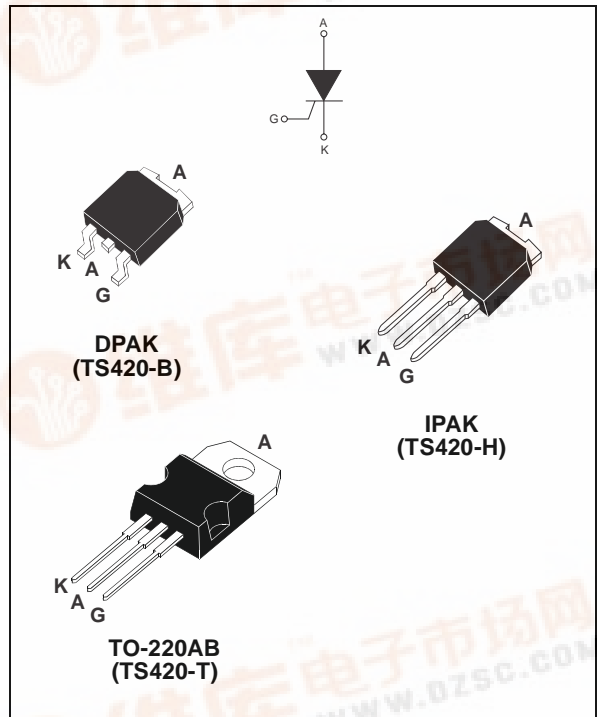

ABSOLUTE RATINGS (limiting values)

Symbol	Parameter		Value	Unit
$I_{T(RMS)}$	RMS on-state current (180° conduction angle)		$T_I = 115^\circ C$	4 A
$I_{T(AV)}$	Average on-state current (180° conduction angle)		$T_I = 115^\circ C$	2.5 A
I_{TSM}	Non repetitive surge peak on-state current	$t_p = 8.3 \text{ ms}$	$T_j = 25^\circ C$	33
		$t_p = 10 \text{ ms}$		30
I^2t	I^2t Value for fusing	$t_p = 10 \text{ ms}$	$T_j = 25^\circ C$	4.5 A^2s
di/dt	Critical rate of rise of on-state current $I_G = 2 \times I_{GT}$, $t_r \leq 100 \text{ ns}$	$F = 60 \text{ Hz}$	$T_j = 125^\circ C$	50 $A/\mu s$
I_{GM}	Peak gate current	$t_p = 20 \mu s$	$T_j = 125^\circ C$	1.2 A
$P_{G(AV)}$	Average gate power dissipation		$T_j = 125^\circ C$	0.2 W
T_{stg} T_j	Storage junction temperature range Operating junction temperature range			- 40 to + 150 - 40 to + 125 $^\circ C$



TS420 Series

ELECTRICAL CHARACTERISTICS (T_j = 25°C, unless otherwise specified)

Symbol	Test Conditions		TS420	Unit	
I _{GT}	V _D = 12 V R _L = 33 Ω	MAX.	200	μA	
V _{GT}		MAX.	0.8	V	
V _{GD}	V _D = V _{DRM} R _L = 3.3 kΩ R _{GK} = 220 Ω	T _j = 125°C	MIN.	0.1	V
V _{RG}	I _{RG} = 10 μA		MIN.	8	V
I _H	I _T = 50 mA R _{GK} = 1 kΩ		MAX.	5	mA
I _L	I _G = 1 mA R _{GK} = 1 kΩ		MAX.	6	mA
dV/dt	V _D = 67 % V _{DRM} R _{GK} = 220 Ω	T _j = 125°C	MIN.	5	V/μs
V _{TM}	I _{TM} = 8 A tp = 380 μs	T _j = 25°C	MAX.	1.6	V
V _{t0}	Threshold voltage	T _j = 125°C	MAX.	0.85	V
R _d	Dynamic resistance	T _j = 125°C	MAX.	90	mΩ
I _{DRM} I _{RRM}	V _{DRM} = V _{RRM} R _{GK} = 220 Ω	T _j = 25°C	MAX.	5	μA
		T _j = 125°C		1	mA

THERMAL RESISTANCES

Symbol	Parameter	Value	Unit	
R _{th(j-c)}	Junction to case (DC)	3.0	°C/W	
R _{th(j-a)}	Junction to ambient (DC)	S = 0.5 cm ² DPAK	70	°C/W
		IPAK	100	
		TO-220AB	60	

S = copper surface under tab

PRODUCT SELECTOR

Part Number	Voltage (xxx)		Sensitivity	Package
	600 V	700 V		
TS420-xxxB	X	X	200 μA	DPAK
TS420-xxxH	X	X	200 μA	IPAK
TS420-xxxT	X	X	200 μA	TO-220AB

ORDERING INFORMATION

<p>TS 4 20 - 600 B (-TR)</p> <p>SCR SERIES ←</p> <p>CURRENT: 4A ←</p> <p>SENSITIVITY: 20: 200μA</p> <p>VOLTAGE: 600: 600V 700: 700V</p> <p>PACKAGE: B: DPAK H: IPAK T: TO-220AB</p> <p>PACKING MODE Blank: Tube -TR: DPAK tape & reel</p>

OTHER INFORMATION

Part Number	Marking	Weight	Base Quantity	Packing mode
TS420-x00B	TS420x00	0.3 g	75	Tube
TS420-x00B-TR	TS420x00	0.3 g	2500	Tape & reel
TS420-x00H	TS420x00	0.4 g	75	Tube
TS420-x00T	TS420x00T	2.3 g	50	Tube

Note: x = voltage

Fig. 1: Maximum average power dissipation versus average on-state current.

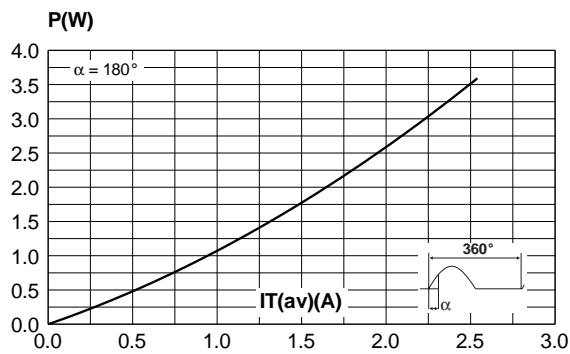

Fig. 2-1: Average and D.C. on-state current versus case temperature.

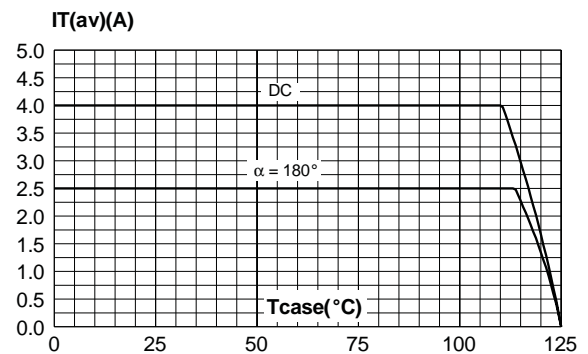

Fig. 2-2: Average and D.C. on-state current versus ambient temperature (device mounted on FR4 with recommended pad layout) (DPAK).

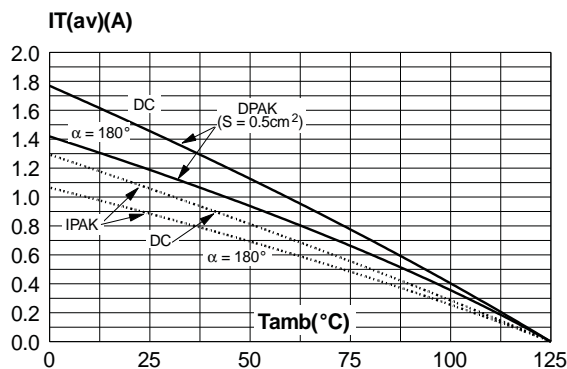

Fig. 3: Relative variation of thermal impedance junction to ambient versus pulse duration (recommended pad layout, FR4 PC board) for DPAK.

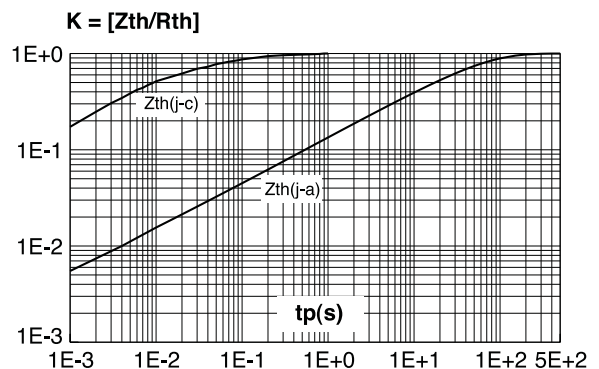

Fig. 4: Relative variation of gate trigger current and holding current versus junction temperature.

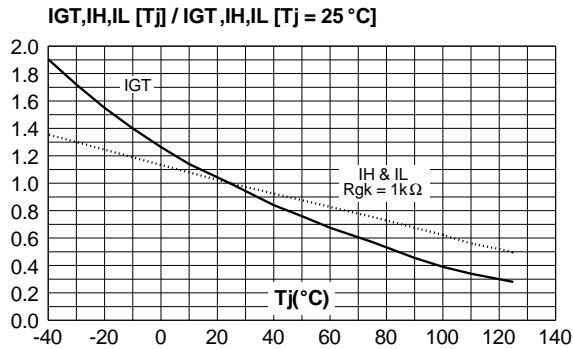

Fig. 5: Relative variation of holding current versus gate-cathode resistance (typical values).

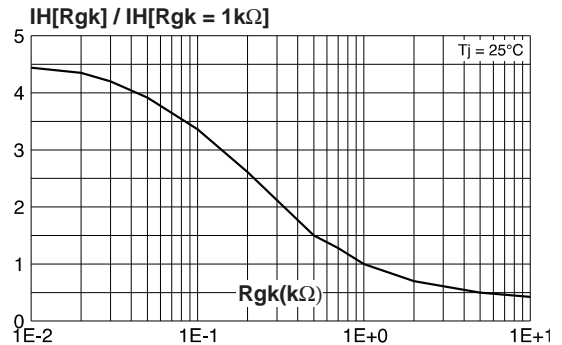

Fig. 6: Relative variation of dV/dt immunity versus gate-cathode resistance (typical values).

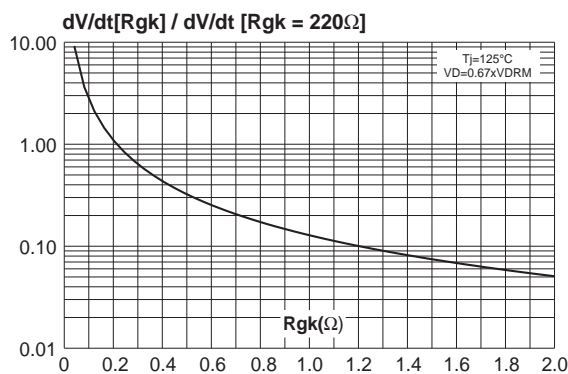

Fig. 7: Relative variation of dV/dt immunity versus gate-cathode resistance (typical values).

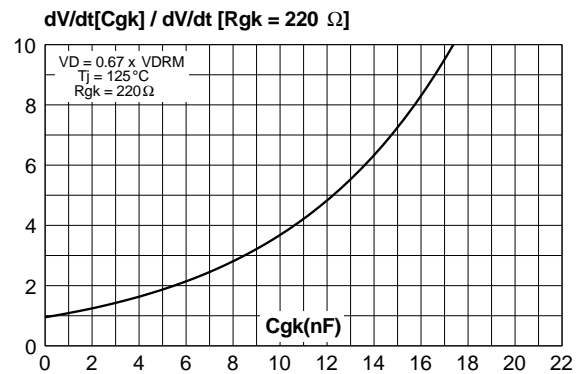

Fig. 8: Surge peak on-state current versus number of cycles.

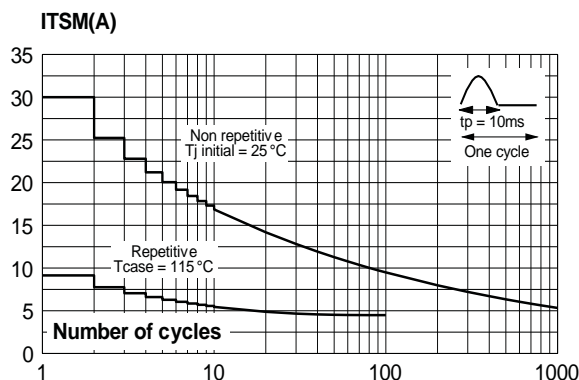

Fig. 9: Non-repetitive surge peak on-state current for a sinusoidal pulse with width $t_p < 10$ ms, and corresponding values of I^2t .

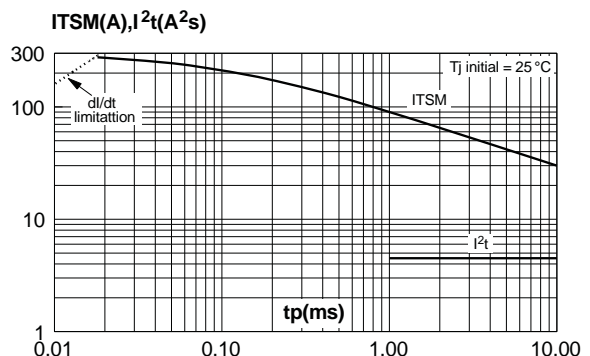

Fig. 10: On-state characteristics (maximum values).

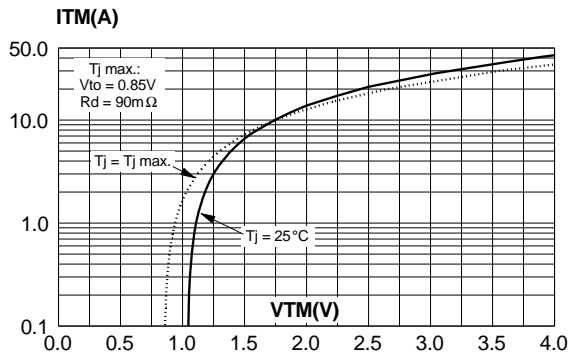
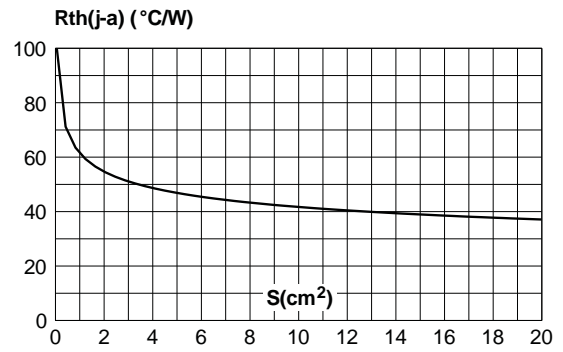

Fig. 11: Thermal resistance junction to ambient versus copper surface under tab (Epoxy printed circuit board FR4, copper thickness: 35 μm) (DPAK).



TS420 Series

PACKAGE MECHANICAL DATA

DPAK (Plastic)

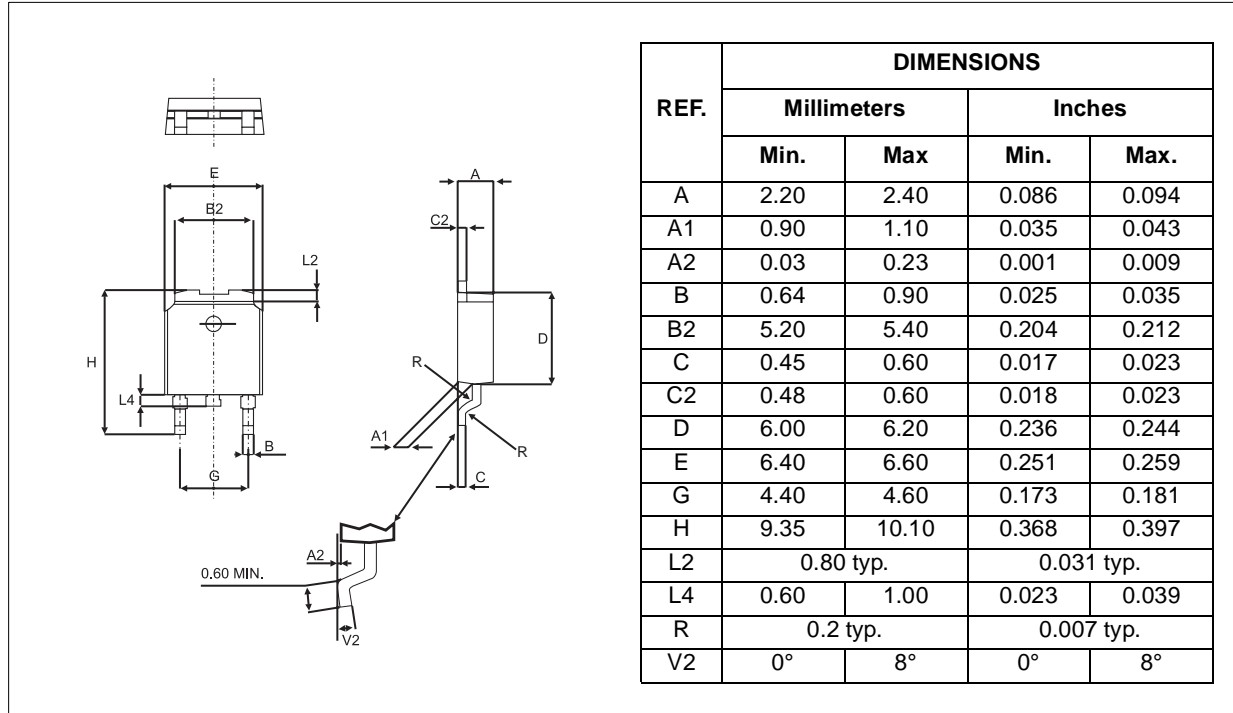

FOOTPRINT DIMENSIONS (in millimeters)

DPAK (Plastic)

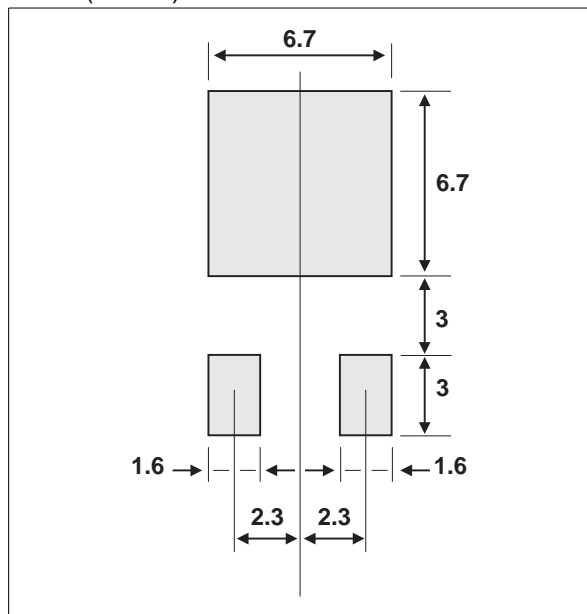

PACKAGE MECHANICAL DATA

IPAK (Plastic)

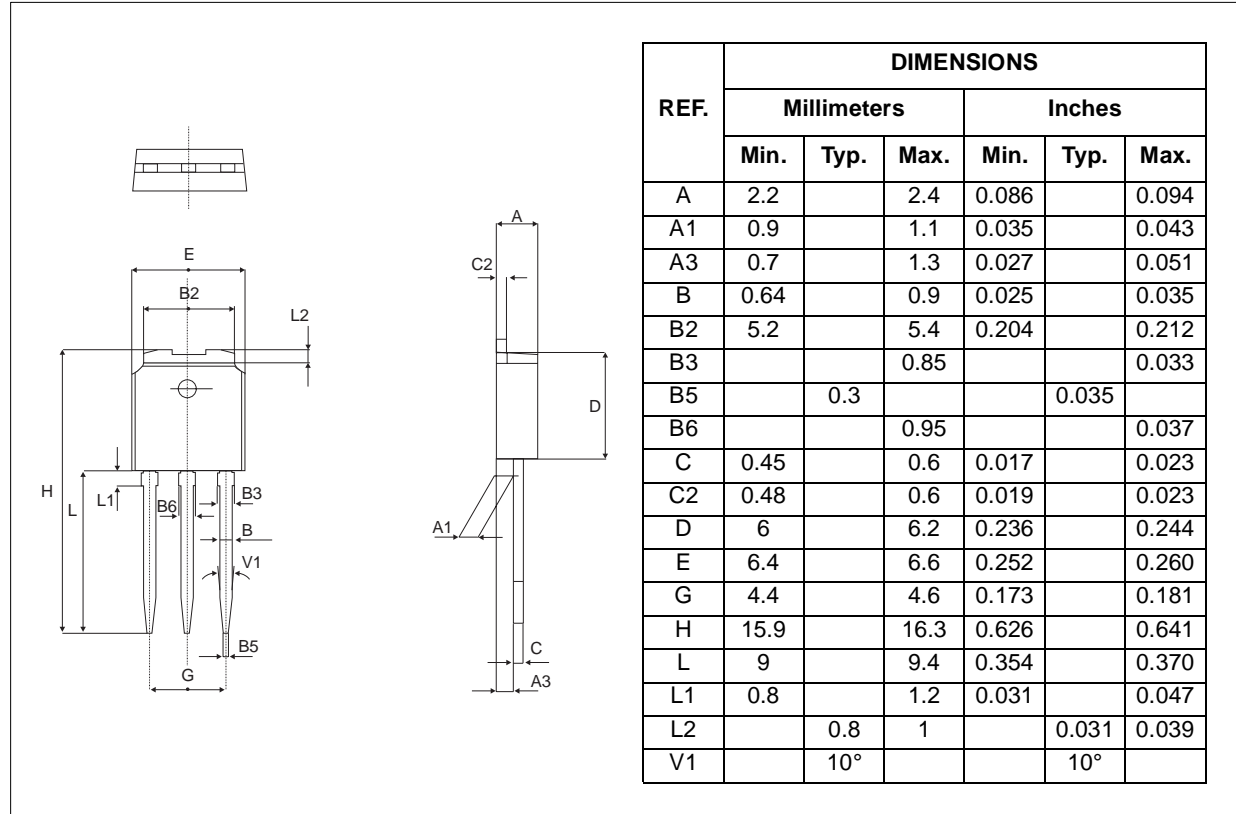

TS420 Series

PACKAGE MECHANICAL DATA

TO-220AB (Plastic)

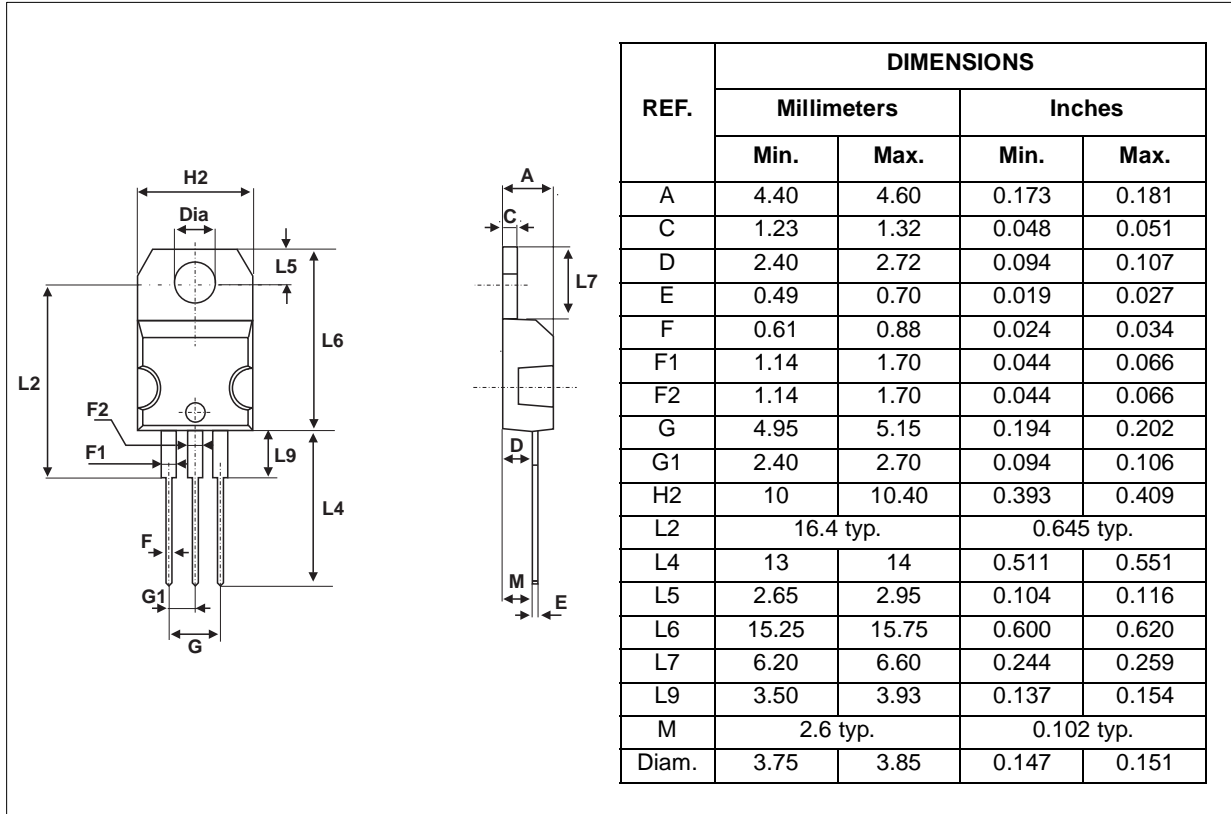

Information furnished is believed to be accurate and reliable. However, STMicroelectronics assumes no responsibility for the consequences of use of such information nor for any infringement of patents or other rights of third parties which may result from its use. No license is granted by implication or otherwise under any patent or patent rights of STMicroelectronics. Specifications mentioned in this publication are subject to change without notice. This publication supersedes and replaces all information previously supplied. STMicroelectronics products are not authorized for use as critical components in life support devices or systems without express written approval of STMicroelectronics.

© The ST logo is a registered trademark of STMicroelectronics

© 2000 STMicroelectronics - Printed in Italy - All Rights Reserved

STMicroelectronics GROUP OF COMPANIES

Australia - Brazil - China - Finland - France - Germany - Hong Kong - India - Italy - Japan - Malaysia - Malta - Morocco
Singapore - Spain - Sweden - Switzerland - United Kingdom

<http://www.st.com>