

查询AR709LT供应商

POSEICO 捷多邦 专业PCB打样工厂, 24小时加急出货

POSEICO

POSEICO SPA

Power SEmiconductors Italian COporation

Via N. Lorenzi 8, 16152 Genova - ITALY

Tel. ++ 39 010 6556234 - Fax ++ 39 010 6557519

Sales Office:

Tel. ++ 39 010 6556775 - Fax ++ 39 010 6442510

RECTIFIER DIODE

AR709LT

Repetitive voltage up to **1000 V**
 Mean forward current **9600 A**
 Surge current **85 kA**

FINAL SPECIFICATION

nov 02 - ISSUE : 02

Symbol	Characteristic	Conditions	Tj [°C]	Value	Unit
BLOCKING					
V _{RRM}	Repetitive peak reverse voltage		190	1000	V
V _{RSM}	Non-repetitive peak reverse voltage		190	1100	V
I _{RRM}	Repetitive peak reverse current	V=VRRM	190	200	mA
CONDUCTING					
I _{F(AV)}	Mean forward current	180° sin ,50 Hz, Th=55°C, double side cooled		9600	A
I _{F(AV)}	Mean forward current	180° sin ,50 Hz, Tc=85°C, double side cooled		9500	A
I _{FSM}	Surge forward current	Sine wave, 10 ms without reverse voltage	190	85	kA
I ² t	I ² t			36125 x 1E3	A ² s
V _{FM}	Forward voltage	Forward current = 6000 A	25	1.14	V
V _{F(TO)}	Threshold voltage		190	0.70	V
r _F	Forward slope resistance		190	0.033	mohm
SWITCHING					
t _{rr}	Reverse recovery time		190		µs
Q _{rr}	Reverse recovery charge				µC
I _{rr}	Peak reverse recovery current				A
MOUNTING					
R _{th(j-h)}	Thermal impedance, DC	Junction to heatsink, double side cooled		9.5	°C/kW
R _{th(c-h)}	Thermal impedance	Case to heatsink, double side cooled		2	°C/kW
T _j	Operating junction temperature			-30 / 190	°C
F	Mounting force			46.0 / 54.0	kN
	Mass			1150	g

ORDERING INFORMATION : AR709LT S 10

standard specification VRRM/100



DISSIPATION CHARACTERISTICS

SQUARE WAVE

Th [°C]

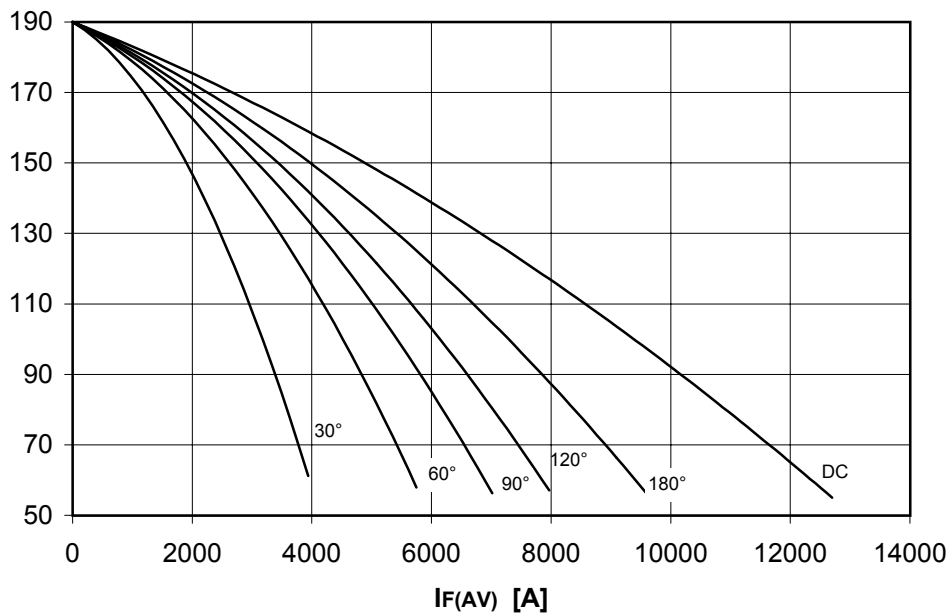

PF(AV) [W]

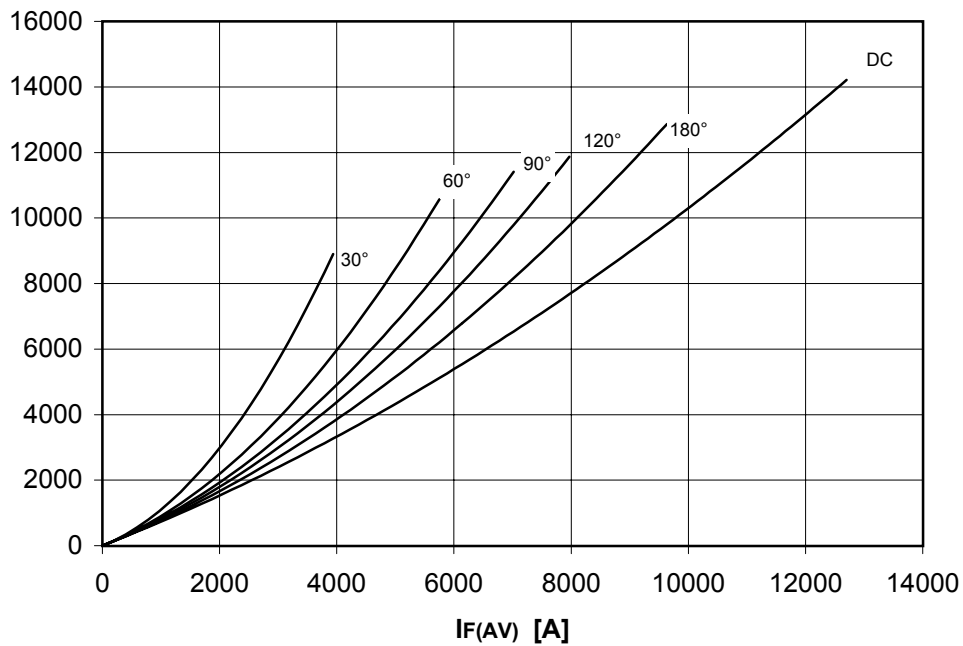

DISSIPATION CHARACTERISTICS

SINE WAVE

Th [°C]

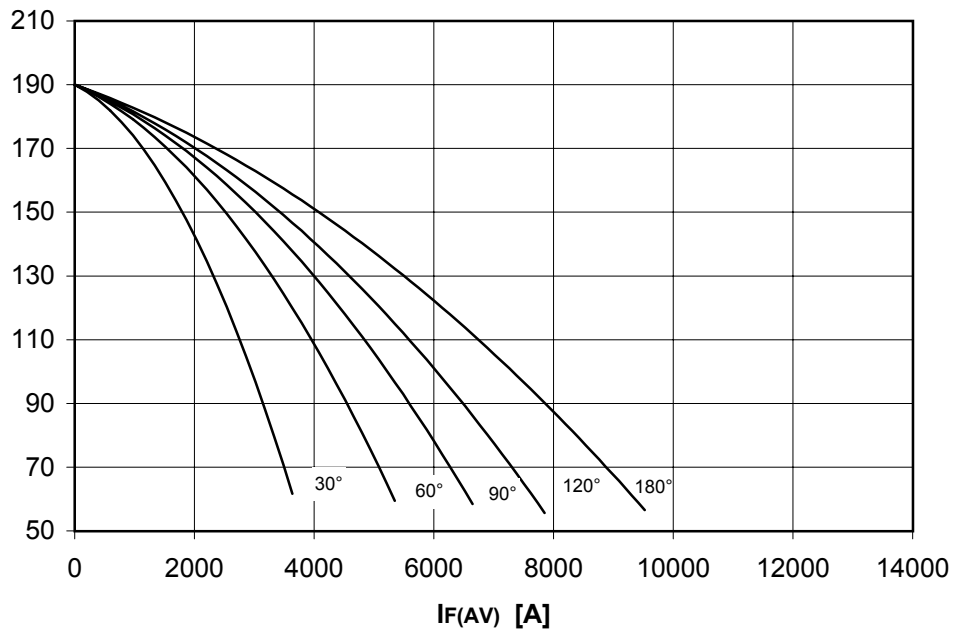

PF(AV) [W]

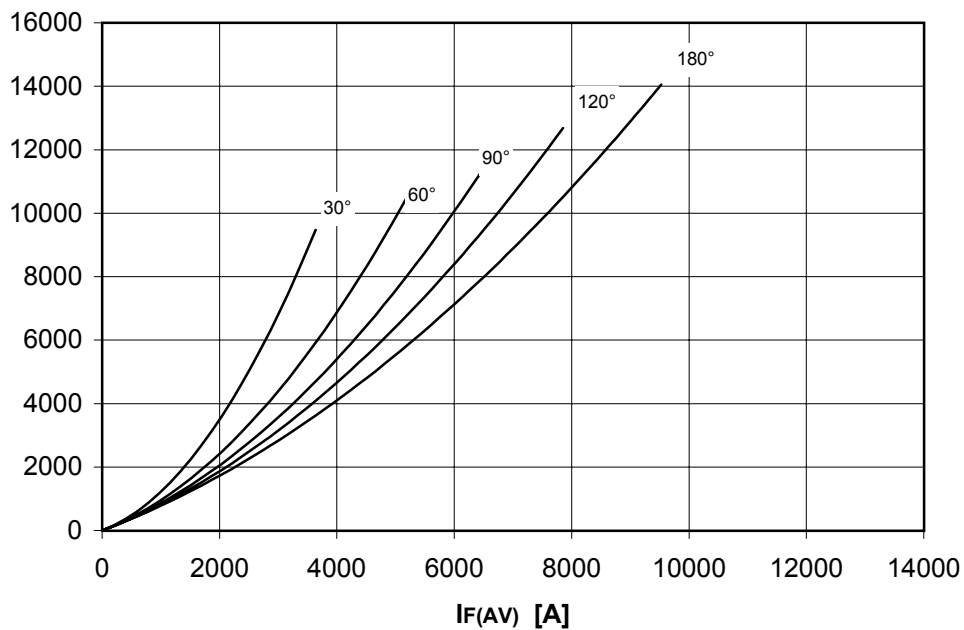

AR709LT RECTIFIER DIODE



FINAL SPECIFICATION nov 02 - ISSUE : 02

FORWARD CHARACTERISTIC
T_j = 190 °C

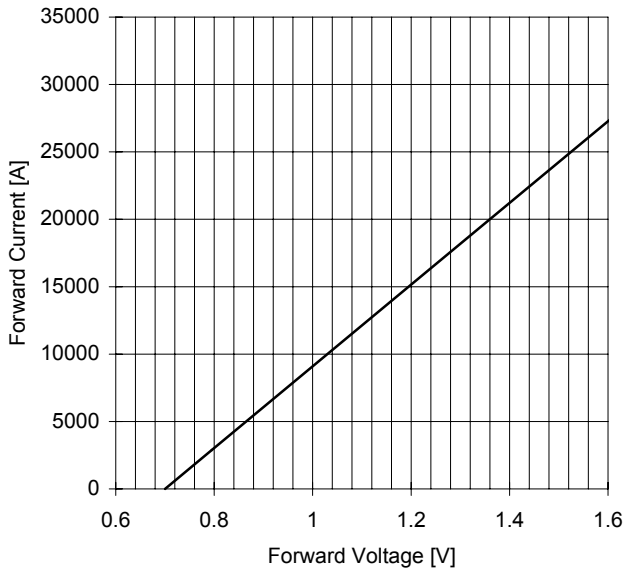

SURGE CHARACTERISTIC
T_j = 190 °C

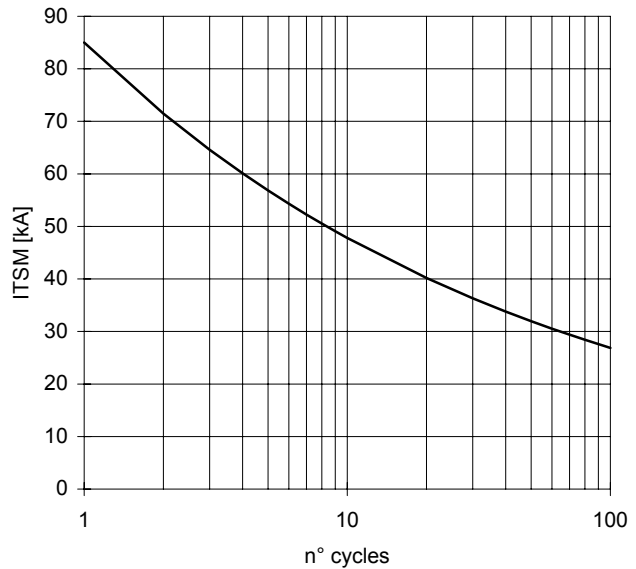

TRANSIENT THERMAL IMPEDANCE
DOUBLE SIDE COOLED

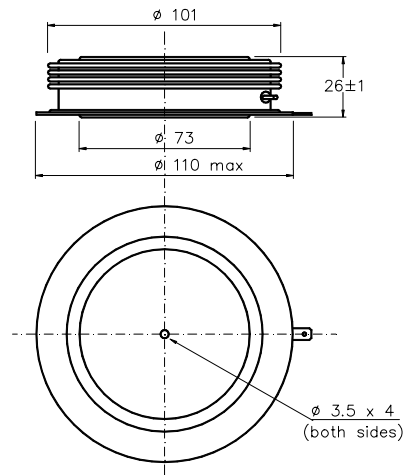
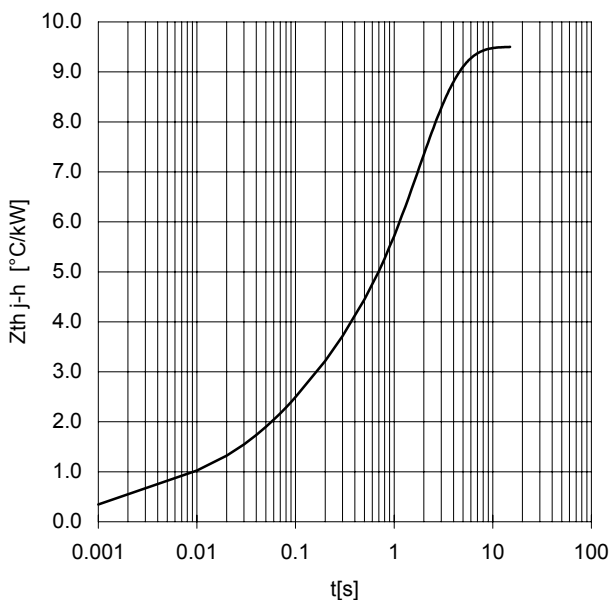

Dimensions
in mm



All the characteristics given in this data sheet are guaranteed only with uniform clamping force, cleaned and lubricated heatsink, surfaces with flatness < .03 mm and roughness < 2 μm.

In the interest of product improvement POSEICO SPA reserves the right to change any data given in this data sheet at any time without previous notice.

If not stated otherwise the maximum value of ratings (symbols over shaded background) and characteristics is reported.

Distributed by

