



## DFA20 SERIES DUAL OUTPUT

### DESCRIPTION

The compact, dual output DFA20 series provides power densities up to 11 watts per cubic inch (0.67 watts per cm<sup>3</sup>). Ideal for battery operated industrial, medical control and remote data collection systems, this converter has fully filtered inputs and outputs. Complete overload protection with independent pulse-by-pulse current limiting and an overtemperature shutdown ensures reliable system operation. Converters with 48 volt inputs are isolated to 1544 volts.

### FEATURES

- Remote ON/OFF and TRIM
- Water Washable Case
- Overcurrent Protection and Thermal Shutdown
- Efficiencies to 85%
- Low Input to Output Capacitance
- 700Volt to 1544Volt Isolation
- Five-Side Shielded Case
- Extended Range Input (2:1)

Selection Chart				
Model	Input Range VDC		Output VDC	Output mA
	Min	Max		
DFA20E12D5	9	18	±5	1700
DFA20E12D12	9	18	±12	850
DFA20E12D15	9	18	±15	700
DFA20E24D5	18	36	±5	1700
DFA20E24D12	18	36	±12	850
DFA20E24D15	18	36	±15	700
DFA20E48D5	36	72	±5	1700
DFA20E48D12	36	72	±12	850
DFA20E48D15	36	72	±15	700

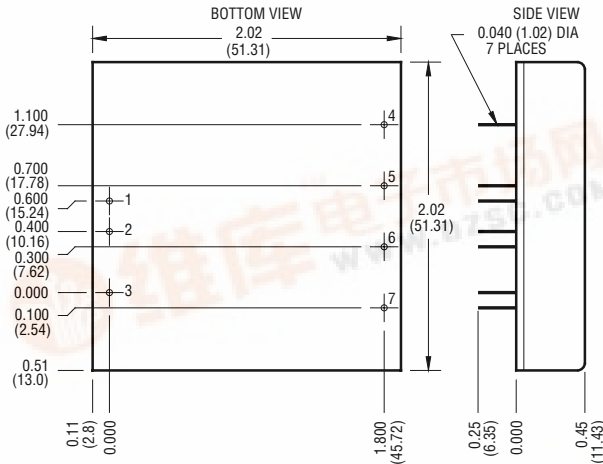

Mechanical tolerances unless otherwise noted:  
 X.XX dimensions: ±0.020 inches  
 X.XXX dimensions: ±0.005 inches

Pin	Function
1	+INPUT
2	-INPUT
3	ON/OFF
4	+OUTPUT
5	COMMON
6	-OUTPUT
7	TRIM

General Specifications (1)			
All Models			Units
<b>ON/OFF Function</b>			
ON Logic Level or Leave Pin Open	MIN	>1.6	VDC
OFF Logic Level or Tie Pin to -Input	MAX	<0.7	VDC
Open Circuit Voltage	TYP	2.5	VDC
Input Resistance	TYP	20	Kohms
Converter Idle Current ON/OFF Pin Low			
12V Models	TYP	3	mA
4V and 48V Models	TYP	5	mA
<b>Isolation (2)</b>			
Breakdown Voltage			
Input to Output 12V , 24V	MIN	700	VDC
Input to Output 48V	MIN	1544	VDC
10 μA Leakage			
Input to Output Capacitance	TYP	500	pF
<b>Output Trim Function</b>			
Trim Range	MIN	±5	%
Input Resistance	MIN	60	Kohms
<b>Environmental</b>			
Case Functional Range, Tc No Derating	MIN MAX	-40 90	°C
Case Functional Range (3)	MIN MAX	-50 100	°C
Storage Range	MIN MAX	-55 105	°C
Thermal Shutdown Case Temperature	TYP	105	°C
Thermal Impedance (4)	TYP	9.5	°C/Watt
<b>General</b>			
MTBF (Calculated)	TYP	800,000	HRS
Unit Weight	TYP	2.3/65	oz/gm
Chassis Mounting Kit 12V, 24V		CM2B2	
Chassis Mounting Kit 48V		CM2A2	

### NOTES (cont)

- (2) Case is electrically connected to Pin 2, -Input.
- (3) The functional case operating range is intended to give an additional data point for evaluating this converter. Sustained operation at the higher operating range will reduce expected operational life. The data sheet specifications are not guaranteed beyond the case operating range.
- (4) The case thermal impedance is specified as the case temperature rise over ambient per package watt dissipated.

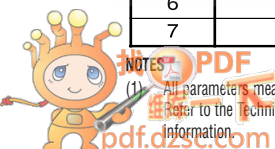

### DFA20 SERIES – DUAL OUTPUT

Input Parameters (1)								
Model		DFA20E12D5	DFA20E12D12	DFA20E12D15	DFA20E24D5	DFA20E24D12	DFA20E48D15	Units
Voltage Range	MIN	9.0			18.0			VDC
	MAX	18.0			36.0			
Reflected Ripple (2)	TYP	350			140			$mA_{pp}$
	TYP	100			40			$mA_{rms}$
Input Current No Load Full Load	TYP	12	12	12	12	12	12	mA
	TYP	1750	2170	2210	875	1010	1030	
Efficiency	TYP	81	78	79	81	84	85	%
Switching Frequency	TYP	220						kHz
Maximum Input Overvoltage, 100 ms maximum	MAX	24			45			VDC
Turn-on Time, 1% Output Error	TYP	6						ms
Model		DFA20E48D5		DFA20E48D12		DFA20E48D15		Units
Voltage Range	MIN	36.0						VDC
	MAX	72.0						
Reflected Ripple (2)	TYP	90						$mA_{pp}$
	TYP	25						$mA_{rms}$
Input Current No Load Full Load	TYP	12		12		12		mA
	TYP	440		505		520		
Efficiency	TYP	81		84		84		%
Switching Frequency	TYP	220						kHz
Maximum Input Overvoltage, 100 ms maximum	MAX	85						VDC
Turn-on Time, 1% Output Error	TYP	10						ms

Output Parameters (1)						
Model		DFA20E12D5 DFA20E24D5 DFA20E48D5	DFA20E12D12 DFA20E24D12 DFA20E48D12	DFA20E12D15 DFA20E24D15 DFA20E48D15	Units	
Output Voltage		±5		±12	±15	VDC
Output Voltage Accuracy	MIN	4.95		11.90	14.90	VDC
	TYP	5.00		12.00	15.00	
	MAX	5.05		12.10	15.10	
Output Balance Plus to Minus Output, Full Load		TYP		< 0.5		%
Rated Load Range	MIN	0.0		0.0	0.0	A
	MAX	1.7		0.85	0.7	
Load Regulation (3)	TYP	0.3		0.1	0.2	%
	MAX	0.7		0.6	0.6	
Cross Regulation (4)	TYP	3		3	3	%
Line Regulation $V_{in} = \text{Min-Max VDC}$	TYP	< 0.1		< 0.2	< 0.2	%
	MAX	0.8		0.8	0.8	
Short Term Stability (5)	TYP	< 0.05				%/24Hrs
Long Term Stability	TYP	< 0.2				%/kHrs
Input Ripple Rejection (6)	TYP	> 40				dB
Noise, 0-20MHz bw (2)	TYP	50		50	50	$mV_{pp}$
RMS Noise, 0.01-1 MHz bw	TYP	15		10	10	$mV_{rms}$
Temperature Coefficient	TYP	50				ppm/°C
	MAX	150				
Short Circuit Protection to Common for all Outputs		Continuous, Current Limit and Thermal Protection				

Specification notes for this page are located on the next page.

## DFA20 SERIES – DUAL OUTPUT

### NOTES

- (1) All parameters measured at Tc=25°C, nominal input voltage and full rated load unless otherwise noted. Refer to the Technical Reference Section for the definition of terms, measurement circuits and other information.
- (2) Noise is measured per Technical Reference Section. Measurement bandwidth is 0-20 MHz for peak-peak measurements, 10 kHz to 1 MHz for RMS measurements. Output noise is measured with a 1µF tantalum located 1" away from the converter to simulate PCB standard decoupling. Input reflected ripple is measured into a 1 µH source impedance.
- (3) Load regulation for the outputs is specified as the voltage change when both outputs are changed from maximum to minimum at the same time.
- (4) Cross regulation is defined as the change in one output when the other output is changed from full load to 25% of full load. The converter can be run at no load on either or both outputs with no damage.
- (5) Short term stability is specified after a 30 minute warmup at full load, constant line and recording the drift over a 24 hour period.
- (6) The input ripple rejection is specified for DC to 120 Hz ripple with a modulation amplitude of 1% of Vin.

### DFA20 SERIES APPLICATION NOTES:

#### External Capacitance Requirements

No external capacitance is required for operation of the DFA20 Series. The use of input capacitors with less than 0.5Ω ESR may cause peaking in the input filter and degrade filter performance. External output capacitance is not required for operation, however it is recommended that 1µF to 10µF of tantalum and 0.001 to 0.1µF ceramic capacitance be selected for reduced system noise. Additional output capacitance may be added for increased filtering, but should not exceed 400µF.

#### Remote ON/OFF Operation

The remote ON/OFF pin may be left floating if this function is not used. It is recommended to drive this pin with an open collector arrangement or a relay contact. When the ON/OFF pin is pulled low with respect to the -INPUT, the converter is placed in a low power drain state.

#### Output TRIM

The TRIM pin may be used to adjust the output ±5% from the nominal setting. This function allows adjustment for voltage drops in the system wiring. Figure 1 shows the proper connections to use this function. If the TRIM function is not required the pin may be left floating.

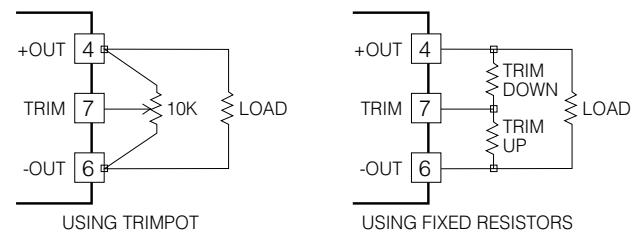
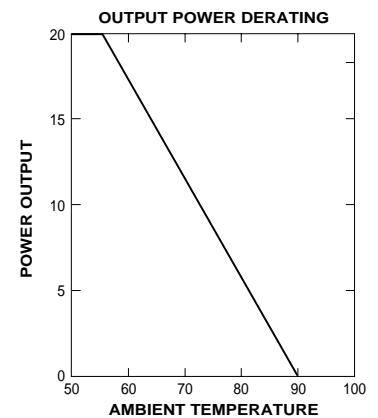
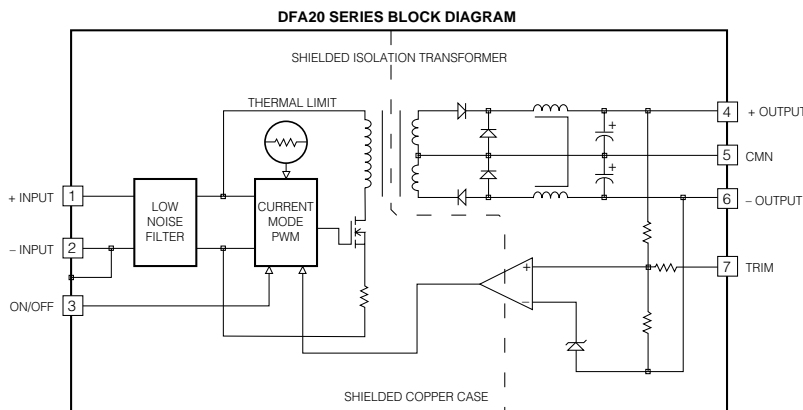
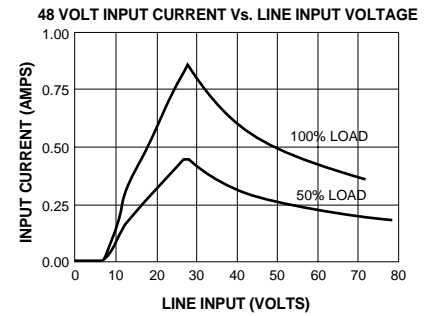
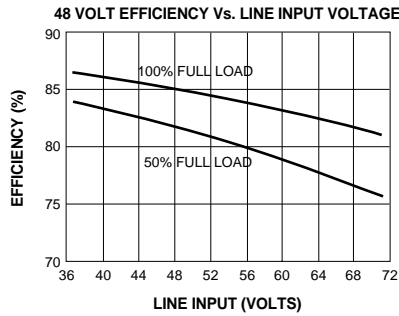
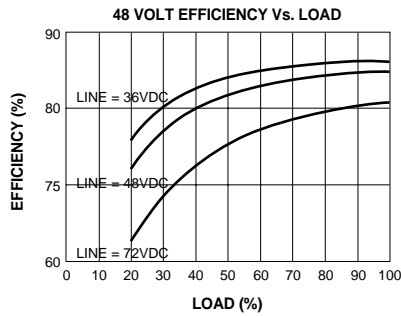
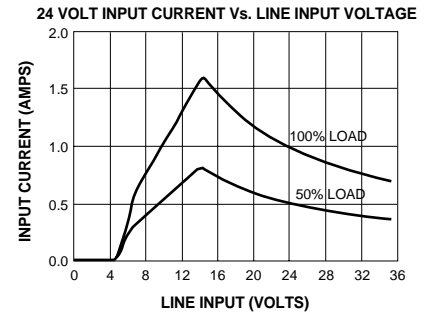
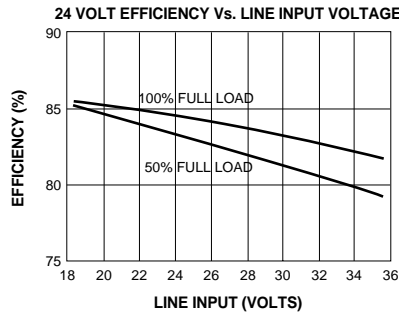
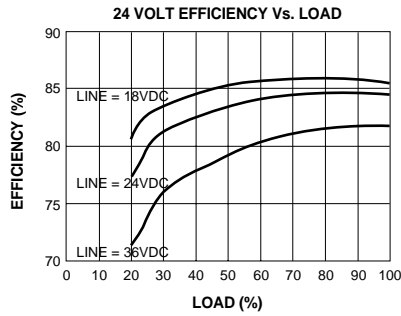
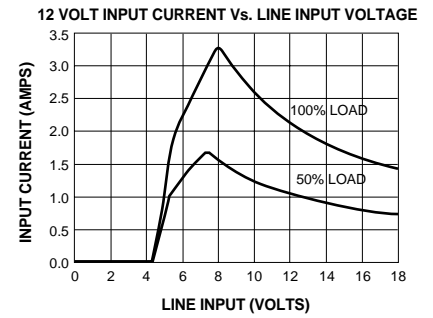
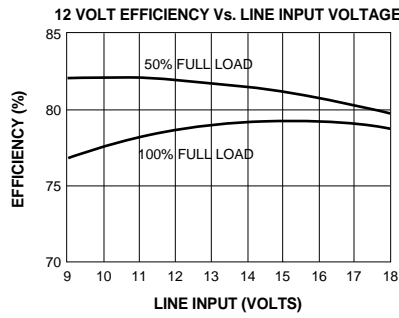
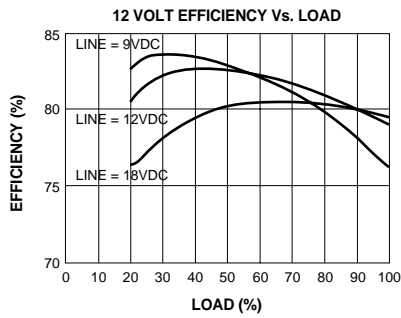

Figure 1.



**DFA20 SERIES – DUAL OUTPUT**

Typical Performance: (Tc=25°C, Vin=Nom VDC, Rated Load)



**NOTES ON USING THE CURVES**

- 1) The input currents are for 20 watts of output power. For  $\pm 5$  volt output models the current is approximately 15% less.
- 2) The efficiency curves are for 12 volt output models. To use for other models adjust as follows:  
 $\pm 5$  volt models subtract approximately 3%.  
 $\pm 15$  volt models add approximately 1%.

