



IL1/ IL2/ IL5

Vishay Semiconductors

Optocoupler, Phototransistor Output, With Base Connection

Features

- Current Transfer Ratio (see order information)
- Isolation Test Voltage 5300 V_{RMS}
- Lead-free component
- Component in accordance to RoHS 2002/95/EC and WEEE 2002/96/EC

Agency Approvals

- UL1577, File No. E52744 System Code H or J, Double Protection
- DIN EN 60747-5-2 (VDE0884)
DIN EN 60747-5-5 pending
Available with Option 1

Description

The IL1/ IL2/ IL5 are optically coupled isolated pairs employing GaAs infrared LEDs and silicon NPN phototransistor. Signal information, including a DC level, can be transmitted by the drive while maintaining a high degree of electrical isolation between input and output. The IL1/ IL2/ IL5 are especially designed for driving medium-speed logic and can be used to eliminate troublesome ground loop and noise problems. These couplers can be used also to replace relays and transformers in many digital interface applications such as CRT modulation.

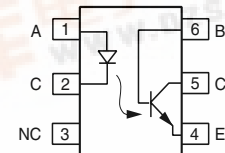
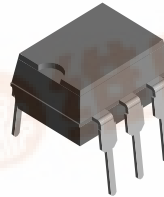

1179004



Order Information

Part	Remarks
IL1	CTR > 20 %, DIP-6
IL2	CTR > 100 %, DIP-6
IL5	CTR > 50 %, DIP-6
IL1-X006	CTR > 20 %, DIP-6 400 mil (option 6)
IL2-X006	CTR > 100 %, DIP-6 400 mil (option 6)
IL2-X009	CTR > 100 %, SMD-6 (option 9)
IL5-X009	CTR > 50 %, SMD-6 (option 9)

For additional information on the available options refer to Option Information.

Absolute Maximum Ratings

T_{amb} = 25 °C, unless otherwise specified

Stresses in excess of the absolute Maximum Ratings can cause permanent damage to the device. Functional operation of the device is not implied at these or any other conditions in excess of those given in the operational sections of this document. Exposure to absolute Maximum Rating for extended periods of the time can adversely affect reliability.

Input

Parameter	Test condition	Symbol	Value	Unit
Reverse voltage		V _R	6.0	V
Forward current		I _F	60	mA
Surge current		I _{FSM}	2.5	A
Power dissipation		P _{diss}	100	mW
Derate linearly from 25 °C			1.33	mW/°C



IL1/ IL2/ IL5



Vishay Semiconductors

Output

Parameter	Test condition	Part	Symbol	Value	Unit
Collector-emitter breakdown voltage		IL1	BV_{CEO}	50	V
		IL2	BV_{CEO}	70	V
		IL5	BV_{CEO}	70	V
Emitter-base breakdown voltage			BV_{EBO}	7.0	V
Collector-base breakdown voltage			BV_{CBO}	70	V
Collector current			I_C	50	mA
	$t < 1.0$ ms		I_C	400	mA
Power dissipation			P_{diss}	200	mW
Derate linearly from 25 °C				2.6	mW/°C

Coupler

Parameter	Test condition	Symbol	Value	Unit
Package power dissipation		P_{tot}	250	mW
Derate linearly from 25 °C			3.3	mW/°C
Isolation test voltage (between emitter and detector referred to standard climate 23 °/50 %RH, DIN 50014)		V_{ISO}	5300	V_{RMS}
Creepage			≥ 7.0	mm
Clearance			≥ 7.0	mm
Comparative tracking index per DIN IEC 112/VDE 0303, part 1			175	
Isolation resistance	$V_{IO} = 500$ V, $T_{amb} = 25$ °C	R_{IO}	$\geq 10^{12}$	Ω
	$V_{IO} = 500$ V, $T_{amb} = 100$ °C	R_{IO}	$\geq 10^{11}$	Ω
Storage temperature		T_{stg}	- 40 to + 150	°C
Operating temperature		T_{amb}	- 40 to + 100	°C
Junction temperature		T_j	100	°C
Soldering temperature	2.0 mm from case bottom	T_{sld}	260	°C

Electrical Characteristics

$T_{amb} = 25$ °C, unless otherwise specified

Minimum and maximum values are testing requirements. Typical values are characteristics of the device and are the result of engineering evaluation. Typical values are for information only and are not part of the testing requirements.

Input

Parameter	Test condition	Symbol	Min	Typ.	Max	Unit
Forward voltage	$I_F = 60$ mA	V_F		1.25	1.65	V
Breakdown voltage	$I_R = 10$ μ A	V_{BR}	6.0	30		V
Reverse current	$V_R = 6.0$ V	I_R		0.01	10	μ A
Capacitance	$V_R = 0$ V, $f = 1.0$ MHz	C_O		40		pF
Thermal resistance junction to lead		R_{thjl}		750		K/W



Output

Parameter	Test condition	Symbol	Min	Typ.	Max	Unit
Collector-emitter capacitance	$V_{CE} = 5.0 \text{ V}, f = 1.0 \text{ MHz}$	C_{CE}		6.8		pF
Collector - base capacitance	$V_{CB} = 5.0 \text{ V}, f = 1.0 \text{ MHz}$	C_{CB}		8.5		pF
Emitter - base capacitance	$V_{EB} = 5.0 \text{ V}, f = 1.0 \text{ MHz}$	C_{EB}		11		pF
Collector-emitter leakage current	$V_{CE} = 10 \text{ V}$	I_{CEO}		5.0	50	nA
Collector-emitter saturation voltage	$I_{CE} = 1.0 \text{ mA}, I_B = 20 \mu\text{A}$	V_{CESAT}		0.25		V
Base-emitter voltage	$V_{CE} = 10 \text{ V}, I_B = 20 \mu\text{A}$	V_{BE}		0.65		V
DC forward current gain	$V_{CE} = 10 \text{ V}, I_B = 20 \mu\text{A}$	HFE	200	650	1800	
DC forward current gain saturated	$V_{CE} = 0.4 \text{ V}, I_B = 20 \mu\text{A}$	HFE_{sat}	120	400	600	
Thermal resistance junction to lead		R_{thjl}		500		K/W

Coupler

Parameter	Test condition	Symbol	Min	Typ.	Max	Unit
Capacitance (input-output)	$V_{I-O} = 0 \text{ V}, f = 1.0 \text{ MHz}$	C_{IO}		0.6		pF
Insulation resistance	$V_{I-O} = 500 \text{ V}$	R_S		10^{14}		Ω

Current Transfer Ratio

Parameter	Test condition	Part	Symbol	Min	Typ.	Max	Unit
Current Transfer Ratio (collector-emitter saturated)	$I_F = 10 \text{ mA}, V_{CE} = 0.4 \text{ V}$	IL1	CTR_{CESat}		75		%
		IL2	CTR_{CESat}		170		%
		IL5	CTR_{CESat}		100		%
Current Transfer Ratio (collector-emitter)	$I_F = 10 \text{ mA}, V_{CE} = 10 \text{ V}$	IL1	CTR_{CE}	20	80	300	%
		IL2	CTR_{CE}	100	200	500	%
		IL5	CTR_{CE}	50	130	400	%
Current Transfer Ratio (collector-base)	$I_F = 10 \text{ mA}, V_{CB} = 9.3 \text{ V}$	IL1	CTR_{CB}		0.25		%
		IL2	CTR_{CB}		0.25		%
		IL5	CTR_{CB}		0.25		%

Switching Non-saturated

Parameter	Current	Delay	Rise time	Storage	Fall time	Propagation H-L	Propagation L-H
Test condition	$V_{CE} = 5.0 \text{ V}, R_L = 75 \Omega, t_p$ measured at 50 % of output						
Symbol	I_F	t_D	t_r	t_S	t_f	t_{PHL}	t_{PLH}
Unit	mA	μs	μs	μs	μs	μs	μs
IL1	20	0.8	1.9	0.2	1.4	0.7	1.4
IL2	4.0	1.7	2.6	0.4	2.2	1.2	2.3
IL5	10	1.7	2.6	0.4	2.2	1.1	2.5

IL1/ IL2/ IL5



Vishay Semiconductors

Switching Saturated

Parameter	Current	Delay	Rise time	Storage	Fall time	Propagation H-L	Propagation L-H
Test condition	$V_{CE} = 0.4 \text{ V}, R_L = 1.0 \text{ k}\Omega, V_{CL} = 5.0 \text{ V}, V_{TH} = 1.5 \text{ V}$						
Symbol	I_F	t_D	t_r	t_s	t_f	t_{PHL}	t_{PLH}
Unit	mA	μs	μs	μs	μs	μs	μs
IL1	20	0.8	1.2	7.4	7.6	1.6	8.6
IL2	5.0	1.0	2.0	5.4	13.5	5.4	7.4
IL5	10	1.7	7.0	4.6	20	2.6	7.2

Common Mode Transient Immunity

Parameter	Test condition	Symbol	Min	Typ.	Max	Unit
Common mode rejection output high	$V_{CM} = 50 \text{ V}_{P-P}, R_L = 1 \text{ k}\Omega, I_F = 10 \text{ mA}$	$ CM_H $		5000		V/ μs
Common mode rejection output low	$V_{CM} = 50 \text{ V}_{P-P}, R_L = 1 \text{ k}\Omega, I_F = 10 \text{ mA}$	$ CM_L $		5000		V/ μs
Common mode coupling capacitance		C_{CM}		0.01		pF

Typical Characteristics ($T_{amb} = 25 \text{ }^\circ\text{C}$ unless otherwise specified)

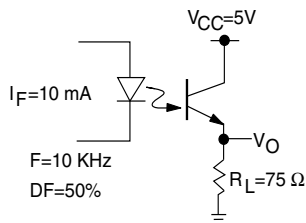

01_01

Figure 1. Non-saturated Switching Schematic

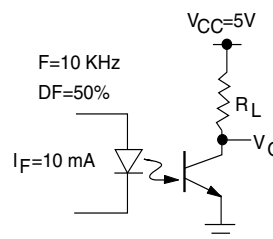

01_02

Figure 2. Saturated Switching Schematic

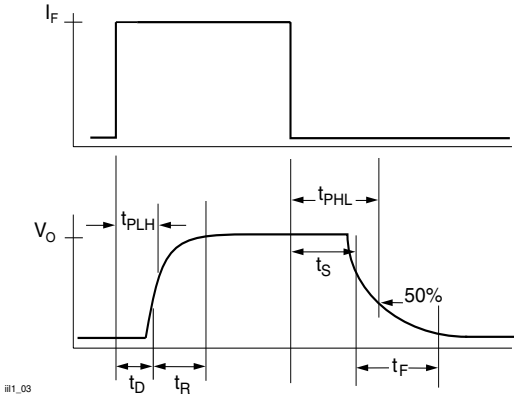

Figure 3. Non-saturated Switching Timing

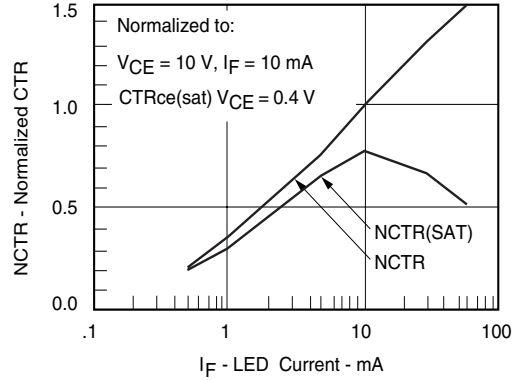

Figure 6. Normalized Non-Saturated and Saturated CTR vs. LED Current

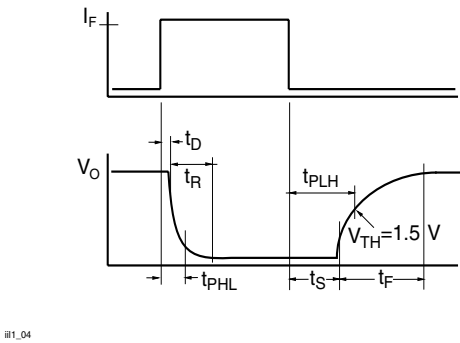

Figure 4. Saturated Switching Timing

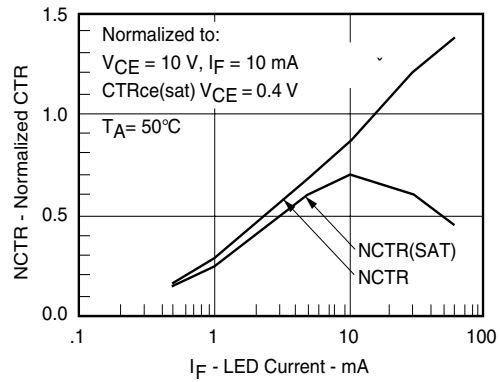

Figure 7. Normalized Non-saturated and Saturated CTR vs. LED Current

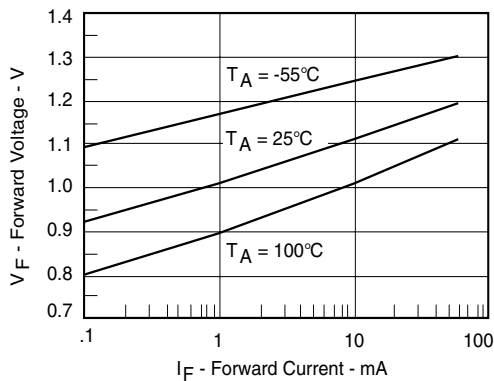

Figure 5. Forward Voltage vs. Forward Current

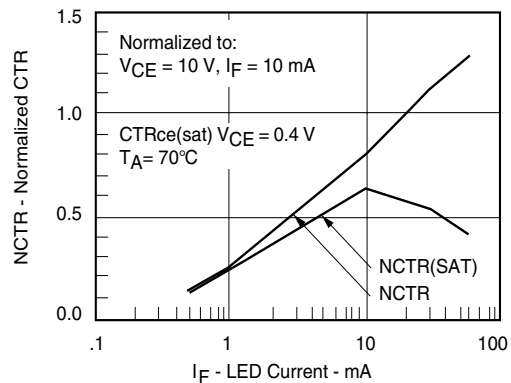
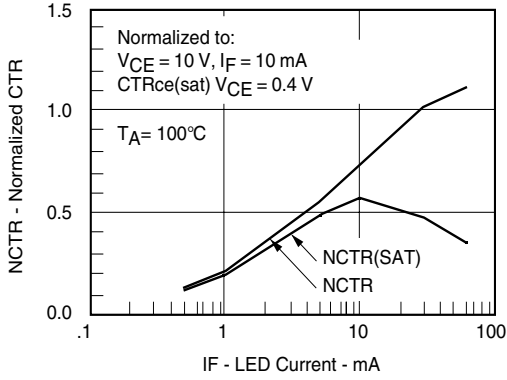
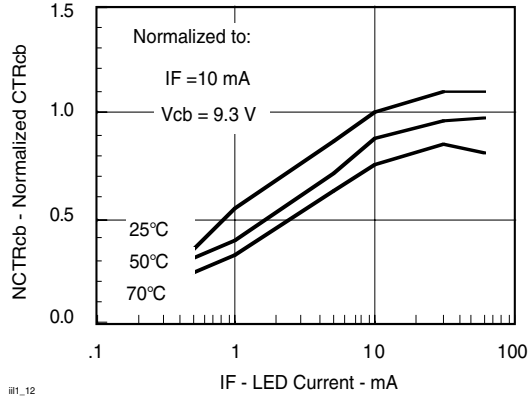

Figure 8. Normalized Non-saturated and saturated CTR vs. LED Current



#1_09

Figure 9. Normalized Non-Saturated and Saturated CTR, $T_A = 100^\circ\text{C}$ vs. LED Current



#1_12

Figure 12. Normalized CTR_{cb} vs. LED Current and Temperature

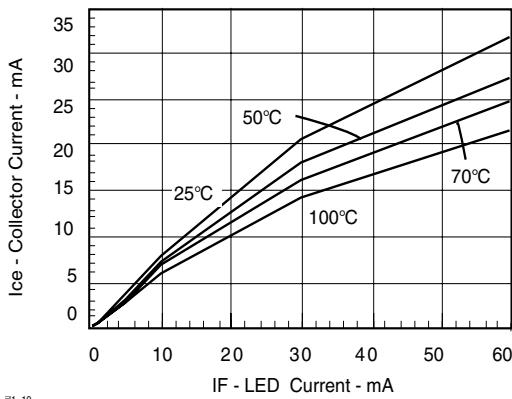

#1_10

Figure 10. Collector-Emitter Current vs. Temperature and LED Current

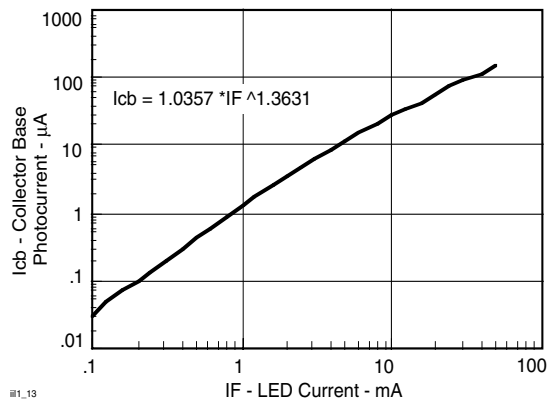

#1_13

Figure 13. Collector-Base Photocurrent vs. LED Current

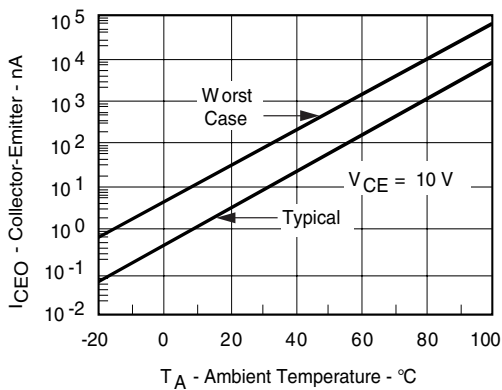

#1_11

Figure 11. Collector-Emitter Leakage Current vs. Temp.

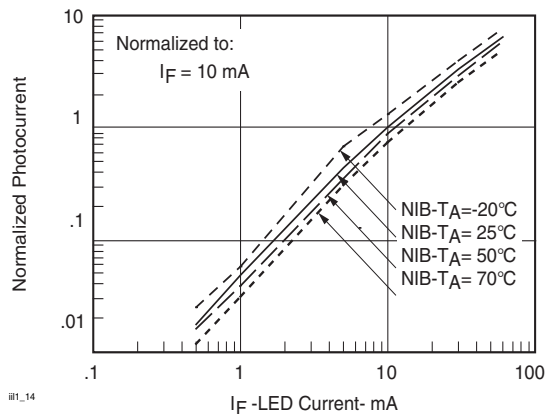

#1_14

Figure 14. Normalized Photocurrent vs. I_F and Temp.

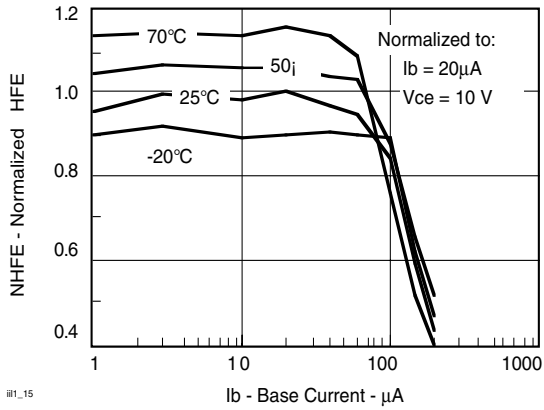

Figure 15. Normalized Non-saturated HFE vs. Base Current and Temperature

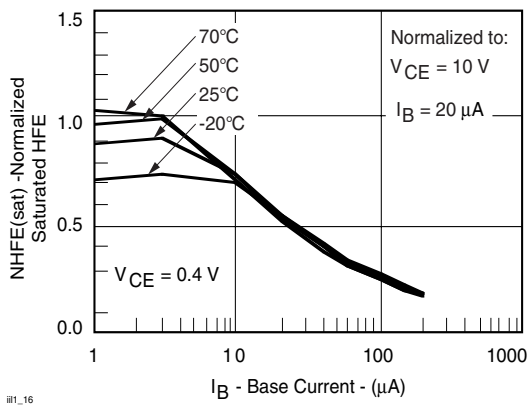

Figure 16. Normalized Saturated HFE vs. Base Current and Temperature

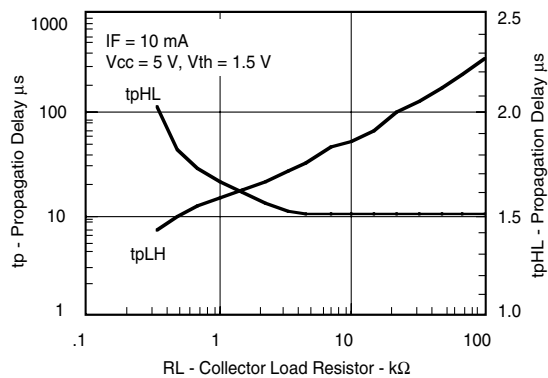

Figure 17. Propagation Delay vs. Collector Load Resistor

IL1/ IL2/ IL5



Vishay Semiconductors

Package Dimensions in Inches (mm)

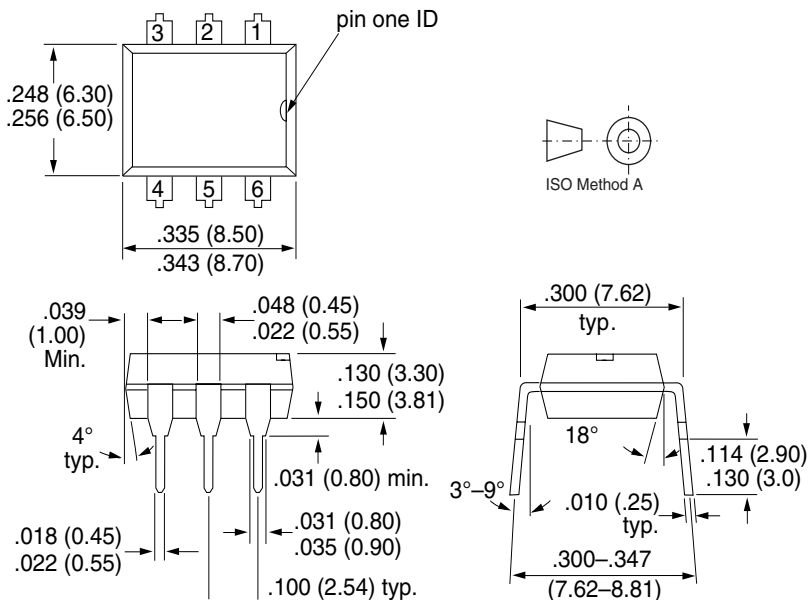

i178004

Option 6

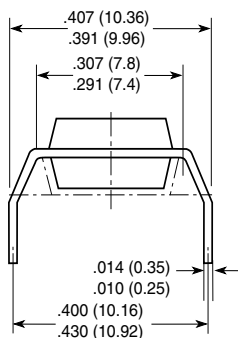

18493

Option 9

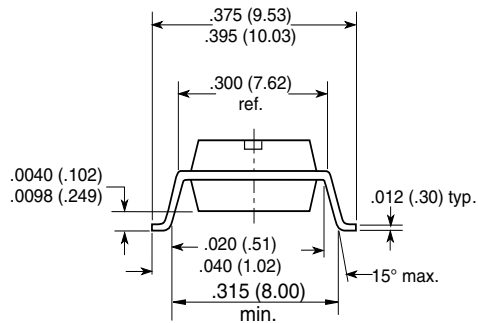



Ozone Depleting Substances Policy Statement

It is the policy of Vishay Semiconductor GmbH to

1. Meet all present and future national and international statutory requirements.
2. Regularly and continuously improve the performance of our products, processes, distribution and operating systems with respect to their impact on the health and safety of our employees and the public, as well as their impact on the environment.

It is particular concern to control or eliminate releases of those substances into the atmosphere which are known as ozone depleting substances (ODSs).

The Montreal Protocol (1987) and its London Amendments (1990) intend to severely restrict the use of ODSs and forbid their use within the next ten years. Various national and international initiatives are pressing for an earlier ban on these substances.

Vishay Semiconductor GmbH has been able to use its policy of continuous improvements to eliminate the use of ODSs listed in the following documents.

1. Annex A, B and list of transitional substances of the Montreal Protocol and the London Amendments respectively
2. Class I and II ozone depleting substances in the Clean Air Act Amendments of 1990 by the Environmental Protection Agency (EPA) in the USA
3. Council Decision 88/540/EEC and 91/690/EEC Annex A, B and C (transitional substances) respectively.

Vishay Semiconductor GmbH can certify that our semiconductors are not manufactured with ozone depleting substances and do not contain such substances.

We reserve the right to make changes to improve technical design and may do so without further notice.

Parameters can vary in different applications. All operating parameters must be validated for each customer application by the customer. Should the buyer use Vishay Semiconductors products for any unintended or unauthorized application, the buyer shall indemnify Vishay Semiconductors against all claims, costs, damages, and expenses, arising out of, directly or indirectly, any claim of personal damage, injury or death associated with such unintended or unauthorized use.

Vishay Semiconductor GmbH, P.O.B. 3535, D-74025 Heilbronn, Germany
Telephone: 49 (0)7131 67 2831, Fax number: 49 (0)7131 67 2423