



1.5KE Series and 1N6267 thru 1N6303A

Vishay Semiconductors
formerly General Semiconductor

TRANSZORB® Transient Voltage Suppressors

V_(BR) Unidirectional 6.8 to 540V
V_(BR) Bidirectional 6.8 to 440V
Peak Pulse Power 1500W

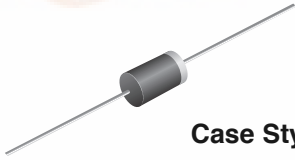

Case Style 1.5KE

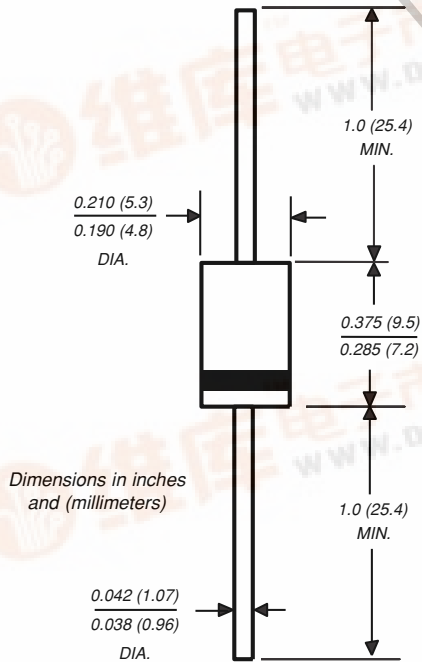

Features

- Underwriters Laboratory Recognition under UL standard for safety 497B: Isolated Loop Circuit Protection
- Glass passivated junction
- 1500W peak pulse power capability on 10/1000µs waveform, repetition rate (duty cycle): 0.05%
- Excellent clamping capability
- Low incremental surge resistance
- Very fast response time
- Includes 1N6267 thru 1N6303A

Mechanical Data

Case: Molded plastic body over passivated junction

Terminals: Plated axial leads, solderable per MIL-STD-750, Method 2026

High temperature soldering guaranteed: 265°C/10 seconds, 0.375" (9.5mm) lead length, 5lbs. (2.3 kg) tension

Polarity: For unidirectional types the color band denotes the cathode, which is positive with respect to the anode under normal TVS operation

Mounting Position: Any **Weight:** 0.045 oz., 1.2 g

Flammability: Epoxy is rated UL 94V-0

Packaging Codes – Options (Antistatic):

- 51 – 1K per Bulk box, 10K/carton
- 54 – 1.4K per 13" paper Reel (52mm horiz. tape), 4.2K/carton
- 73 – 1K per horiz. tape & Ammo box, 10K/carton

Devices for Bidirectional Applications

For bi-directional, use C or CA suffix for types 1.5KE6.8 thru types 1.5KE440 (e.g. 1.5KE6.8C, 1.5KE440CA). Electrical characteristics apply in both directions.

Maximum Ratings and Characteristics (T_A = 25°C unless otherwise noted)

Parameter	Symbol	Limit	Unit
Peak power dissipation with a 10/1000µs waveform ⁽¹⁾ (Fig. 1)	PPPM	1500	W
Peak pulse current with a 10/1000µs waveform ⁽¹⁾	IPPM	See Next Table	A
Steady state power dissipation at T _L = 75°C, lead lengths 0.375" (9.5mm) ⁽²⁾	PM(AV)	6.5	W
Peak forward surge current, 8.3ms single half sine-wave unidirectional only ⁽³⁾	IFSM	200	A
Maximum instantaneous forward voltage at 100A for unidirectional only ⁽⁴⁾	V _F	3.5/5.0	V
Typical thermal resistance junction-to-lead	R _{θJL}	20	°C/W
Typical thermal resistance junction-to-ambient	R _{θJA}	75	°C/W
Operating junction and storage temperature range	T _J , T _{STG}	-55 to +175	°C

Notes: (1) Non-repetitive current pulse, per Fig.3 and derated above T_A = 25°C per Fig. 2

(2) Mounted on copper pad area of 1.6 x 1.6" (40 x 40mm) per Fig. 5

(3) Measured on 8.3ms single half sine-wave or equivalent square wave, duty cycle = 4 pulses per minute maximum

(4) V_F = 3.5V for 1.5KE220(A) & below; V_F = 5.0V for 1.5KE250(A) & above

1.5KE Series and 1N6267 thru 1N6303A



Vishay Semiconductors
formerly General Semiconductor

Electrical Characteristics (T_A = 25°C unless otherwise noted)

JEDEC Type Number	General Semiconductor Part Number	Breakdown Voltage V _(BR) at I _T ⁽¹⁾ (V)		Test Current I _T (mA)	Stand-off Voltage V _{WM} (V)	Maximum Reverse Leakage at V _{WM} I _D ⁽⁴⁾ (μA)	Maximum Peak Pulse Current I _{PPM} ⁽²⁾ (A)	Maximum Clamping Voltage at I _{PPM} V _C (V)	Maximum Temp. Coefficient of V _(BR) (% / °C)
		Min	Max						
1N6267	+1.5KE6.8	6.12	7.48	10	5.50	1000	139	10.8	0.057
1N6267A	+1.5KE6.8A	6.45	7.14	10	5.80	1000	143	10.5	0.057
1N6268	+1.5KE7.5	6.75	8.25	10	6.05	500	128	11.7	0.061
1N6268A	+1.5KE7.5A	7.13	7.88	10	6.40	500	133	11.3	0.061
1N6269	+1.5KE8.2	7.38	9.02	10	6.63	200	120	12.5	0.065
1N6269A	+1.5KE8.2A	7.79	8.61	10	7.02	200	124	12.1	0.065
1N6270	+1.5KE9.1	8.19	10.0	1.0	7.37	50	109	13.8	0.068
1N6270A	+1.5KE9.1A	8.65	9.55	1.0	7.78	50	112	13.4	0.068
1N6271	+1.5KE10	9.00	11.0	1.0	8.10	10	100	15.0	0.073
1N6271A	+1.5KE10A	9.50	10.5	1.0	8.55	10	103	14.5	0.073
1N6272	+1.5KE11	9.90	12.1	1.0	8.92	5.0	92.6	16.2	0.075
1N6272A	+1.5KE11A	10.5	11.6	1.0	9.40	5.0	96.2	15.6	0.075
1N6273	+1.5KE12	10.8	13.2	1.0	9.72	5.0	86.7	17.3	0.076
1N6273A	+1.5KE12A	11.4	12.6	1.0	10.2	5.0	89.8	16.7	0.078
1N6274	+1.5KE13	11.7	14.3	1.0	10.5	5.0	78.9	19.0	0.081
1N6274A	+1.5KE13A	12.4	13.7	1.0	11.1	5.0	82.4	18.2	0.081
1N6275	+1.5KE15	13.5	16.5	1.0	12.1	1.0	68.2	22.0	0.084
1N6275A	+1.5KE15A	14.3	15.8	1.0	12.8	1.0	70.8	21.2	0.084
1N6276	+1.5KE16	14.4	17.6	1.0	12.9	1.0	63.8	23.5	0.086
1N6276A	+1.5KE16A	15.2	16.8	1.0	13.6	1.0	66.7	22.5	0.086
1N6277	+1.5KE18	16.2	19.8	1.0	14.5	1.0	56.6	26.5	0.088
1N6277A	+1.5KE18A	17.1	18.9	1.0	15.3	1.0	59.5	25.2	0.089
1N6278	+1.5KE20	18.0	22.0	1.0	16.2	1.0	51.5	29.1	0.090
1N6278A	+1.5KE20A	19.0	21.0	1.0	17.1	1.0	54.2	27.7	0.090
1N6279	+1.5KE22	19.8	24.2	1.0	17.8	1.0	47.0	31.9	0.092
1N6279A	+1.5KE22A	20.9	23.1	1.0	18.8	1.0	49.0	30.6	0.092
1N6280	+1.5KE24	21.6	26.4	1.0	19.4	1.0	43.2	34.7	0.094
1N6280A	+1.5KE24A	22.8	25.2	1.0	20.5	1.0	45.2	33.2	0.094
1N6281	+1.5KE27	24.3	29.7	1.0	21.8	1.0	38.4	39.1	0.096
1N6281A	+1.5KE27A	25.7	28.4	1.0	23.1	1.0	40.0	37.5	0.096
1N6282	+1.5KE30	27.0	33.0	1.0	24.3	1.0	34.5	43.5	0.097
1N6282A	+1.5KE30A	28.5	31.5	1.0	25.6	1.0	36.2	41.4	0.097
1N6283	+1.5KE33	29.7	36.3	1.0	26.8	1.0	31.4	47.7	0.098
1N6283A	+1.5KE33A	31.4	34.7	1.0	28.2	1.0	32.8	45.7	0.098
1N6284	+1.5KE36	32.4	39.6	1.0	29.1	1.0	28.8	52.0	0.099
1N6284A	+1.5KE36A	34.2	37.8	1.0	30.8	1.0	30.1	49.9	0.099
1N6285	+1.5KE39	35.1	42.9	1.0	31.6	1.0	26.6	56.4	0.100
1N6285A	+1.5KE39A	37.1	41.0	1.0	33.3	1.0	27.8	53.9	0.100
1N6286	+1.5KE43	38.7	47.3	1.0	34.8	1.0	24.2	61.9	0.101
1N6286A	+1.5KE43A	40.9	45.2	1.0	36.8	1.0	25.3	59.3	0.101
1N6287	+1.5KE47	42.3	51.7	1.0	38.1	1.0	22.1	67.8	0.101
1N6287A	+1.5KE47A	44.7	49.4	1.0	40.2	1.0	23.1	64.8	0.101
1N6288	+1.5KE51	45.9	56.1	1.0	41.3	1.0	20.4	73.5	0.102
1N6288A	+1.5KE51A	48.5	53.6	1.0	43.6	1.0	21.4	70.1	0.102
1N6289	+1.5KE56	50.4	61.8	1.0	45.4	1.0	18.6	80.5	0.103
1N6289A	+1.5KE56A	53.2	58.8	1.0	47.8	1.0	19.5	77.0	0.103
1N6290	+1.5KE62	55.8	68.2	1.0	50.2	1.0	16.9	89.0	0.104
1N6290A	+1.5KE62A	58.9	65.1	1.0	53.0	1.0	17.6	85.0	0.104
1N6291	+1.5KE68	61.2	74.8	1.0	55.1	1.0	15.3	98.0	0.104
1N6291A	+1.5KE68A	64.6	71.4	1.0	58.1	1.0	16.3	92.0	0.104
1N6292	+1.5KE75	67.5	82.5	1.0	60.7	1.0	13.9	109	0.105



1.5KE Series and 1N6267 thru 1N6303A

Vishay Semiconductors
formerly General Semiconductor

Electrical Characteristics (Cont'd) (T_A = 25°C unless otherwise noted)

JEDEC Type Number	General Semiconductor Part Number	Breakdown Voltage V _(BR) at I _T ⁽¹⁾ (V)		Test Current I _T (mA)	Stand-off Voltage V _{WM} (V)	Maximum Reverse Leakage at V _{WM} I _D ⁽⁴⁾ (μA)	Maximum Peak Pulse Current I _{PPM} ⁽²⁾ (A)	Maximum Clamping Voltage at I _{PPM} V _C (V)	Maximum Temp. Coefficient of V _(BR) (% / °C)
		Min	Max						
1N6292A	+1.5KE75A	71.3	78.8	1.0	64.1	1.0	14.6	104	0.105
1N6293	+1.5KE82	73.8	90.2	1.0	66.4	1.0	12.7	118	0.105
1N6293A	+1.5KE82A	77.9	86.1	1.0	70.1	1.0	13.3	113	0.105
1N6294	+1.5KE91	81.9	100.0	1.0	73.7	1.0	11.5	131	0.106
1N6294A	+1.5KE91A	86.5	95.5	1.0	77.8	1.0	12.0	125	0.106
1N6295	+1.5KE100	90.0	110	1.0	81.0	1.0	10.4	144	0.106
1N6295A	+1.5KE100A	95.0	105	1.0	85.5	1.0	10.9	137	0.106
1N6296	+1.5KE110	99.0	121	1.0	89.2	1.0	9.5	158	0.107
1N6296A	+1.5KE 110A	105	116	1.0	94.0	1.0	9.9	152	0.107
1N6297	+1.5KE120	108	132	1.0	97.2	1.0	8.7	173	0.107
1N6297A	+1.5KE120A	114	126	1.0	102	1.0	9.1	165	0.107
1N6298	+1.5KE130	117	143	1.0	105	1.0	8.0	187	0.107
1N6298A	+1.5KE130A	124	137	1.0	111	1.0	8.4	179	0.107
1N6299	+1.5KE150	136	165	1.0	121	1.0	7.0	215	0.108
1N6299A	+1.5KE150A	143	158	1.0	128	1.0	7.2	207	0.106
1N6300	+1.5KE160	144	176	1.0	130	1.0	6.5	230	0.106
1N6300A	+1.5KE160A	152	168	1.0	136	1.0	6.8	219	0.108
1N6301	+1.5KE170	153	187	1.0	138	1.0	6.1	244	0.108
1N6301A	+1.5KE170A	162	179	1.0	145	1.0	6.4	234	0.108
1N6302	1.5KE180	162	198	1.0	146	1.0	5.8	258	0.108
1N6302A	1.5KE180A	171	189	1.0	154	1.0	6.1	246	0.108
1N6303	1.5KE200	180	220	1.0	162	1.0	5.2	287	0.108
1N6303A	1.5KE200*	190	210	1.0	171	1.0	5.5	274	0.108
	1.5KE220	198	242	1.0	175	1.0	4.4	344	0.108
	1.5KE220A*	209	231	1.0	185	1.0	4.6	328	0.108
	1.5KE250	225	275	1.0	202	1.0	4.2	360	0.110
	1.5KE250A	237	263	1.0	214	1.0	4.4	344	0.110
	1.5KE300	270	330	1.0	243	1.0	3.5	430	0.110
	1.5KE300A	285	315	1.0	256	1.0	3.6	414	0.110
	1.5KE350	315	385	1.0	284	1.0	3.0	504	0.110
	1.5KE350A	333	368	1.0	300	1.0	3.1	482	0.110
	1.5KE400	360	440	1.0	324	1.0	2.6	574	0.110
	1.5KE400A	380	420	1.0	342	1.0	2.7	548	0.110
	1.5KE440	396	484	1.0	356	1.0	2.4	631	0.110
	1.5KE440A	418	462	1.0	376	1.0	2.5	602	0.110
	1.5KE480	432	528	1.0	389	1.0	2.19	686	0.110
	1.5KE480A	456	504	1.0	408	1.0	2.28	658	0.110
	1.5KE510	459	561	1.0	413	1.0	2.06	729	0.110
	1.5KE510A	485	535	1.0	434	1.0	2.15	698	0.110
	1.5KE540	486	594	1.0	437	1.0	1.94	772	0.110
	1.5KE540A	513	567	1.0	459	1.0	2.03	740	0.110

Notes: (1) Pulse test: t_p ≤ 50ms

(2) Surge current waveform per Fig. 3 and derate per Fig. 2

(3) All terms and symbols are consistent with ANSI/IEEE CA62.35

(4) For bidirectional types with V_R 10 volts and less the I_D limit is doubled

* Bidirectional versions are UL approved under component across the line protection, ULV1414 file number E108274 (1.5KE200CA, 1.5KE220CA)

+ Underwriters Laboratory Recognition for the classification of protectors (QVGQ2) under the UL standard for safety 497B and file number E136766 for both uni-directional and bi-directional devices

Application

- This series of Silicon Transient Suppressors is used in applications where large voltage transients can permanently damage voltage-sensitive components.
- The TVS diode can be used in applications where induced lightning on rural or remote transmission lines presents a hazard to electronic circuitry (ref: R.E.A. specification P.E. 60).
- This Transient Voltage Suppressor diode has a pulse power rating of 1500 watts for one millisecond. The response time of TVS diode clamping action is effectively instantaneous (1 x 10⁻⁹ seconds bidirectional); therefore, they can protect integrated circuits, MOS devices, hybrids, and other voltage sensitive semiconductors and components. TVS diodes can also be used in series or parallel to increase the peak power ratings.

1.5KE Series and 1N6267 thru 1N6303A



Vishay Semiconductors
formerly General Semiconductor

Ratings and Characteristic Curves ($T_A = 25^\circ\text{C}$ unless otherwise noted)

Fig. 1 – Peak Pulse Power Rating Curve

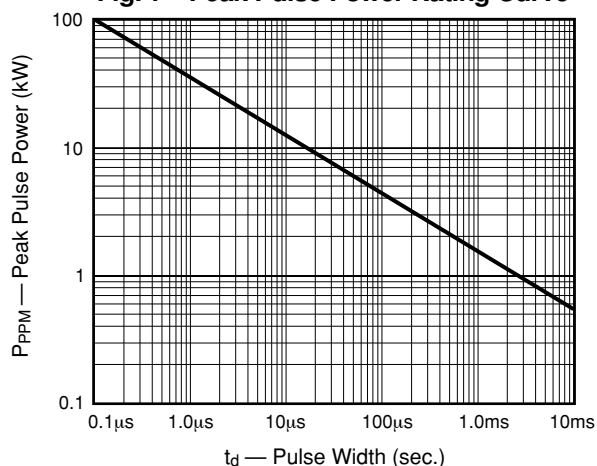

Fig. 2 – Pulse Derating Curve

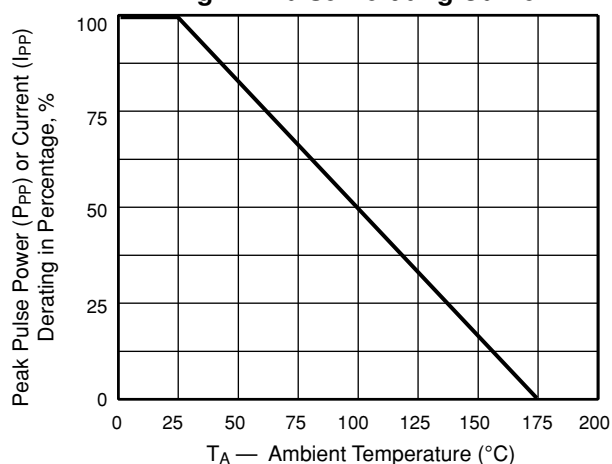

Fig. 3 – Pulse Waveform

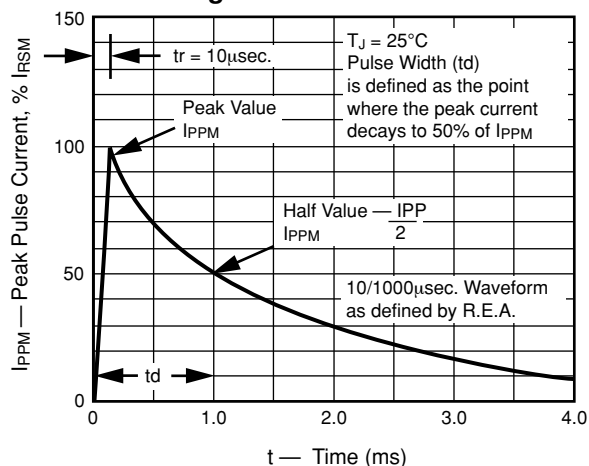

Fig. 4 - Typical Junction Capacitance

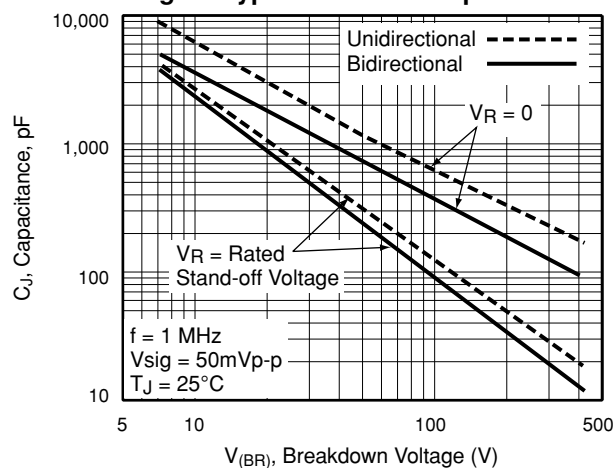

Fig. 5 – Steady State Power Derating Curve

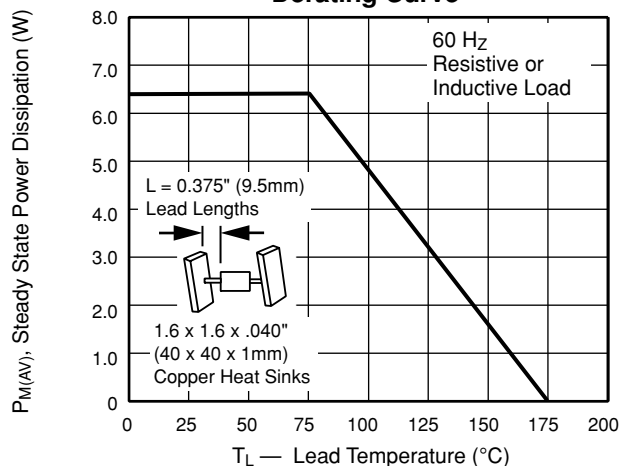
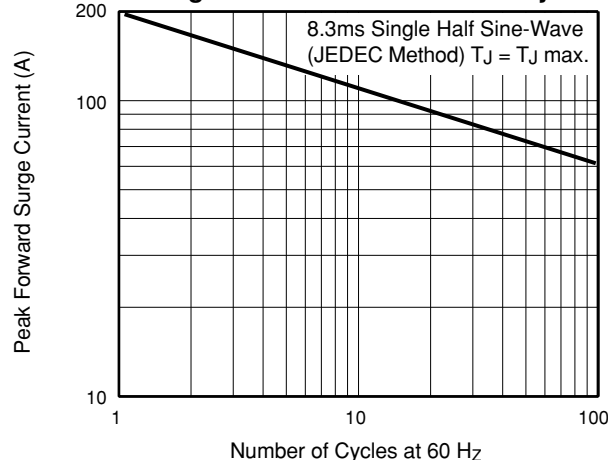

Fig. 6 - Maximum Non-repetitive Peak Forward Surge Current Unidirectional Only





1.5KE Series and 1N6267 thru 1N6303A

Vishay Semiconductors
formerly General Semiconductor

Ratings and Characteristic Curves (T_A = 25°C unless otherwise noted)

Fig. 7 – Incremental Clamping Voltage Curve (Unidirectional)

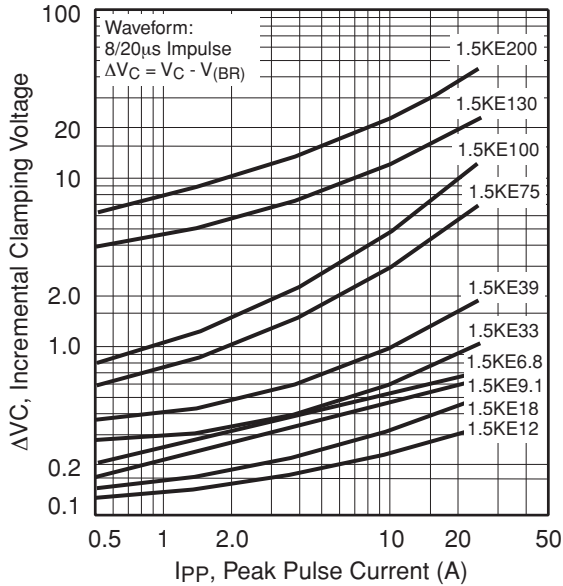

Fig. 8 – Incremental Clamping Voltage Curve (Unidirectional)

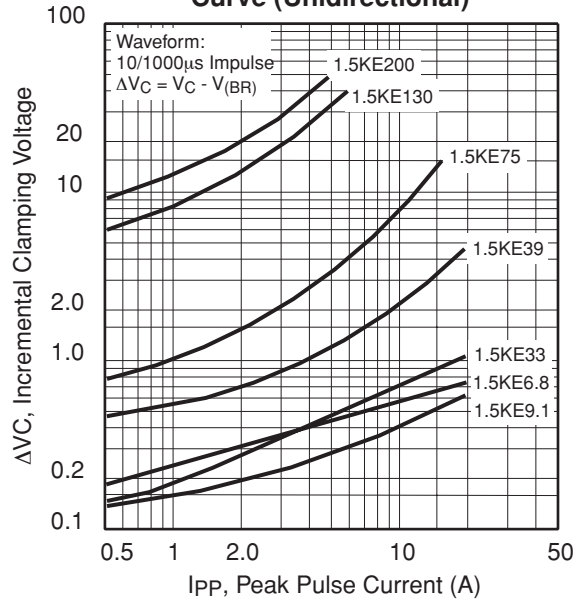

Fig. 7 – Incremental Clamping Voltage Curve (Bidirectional)

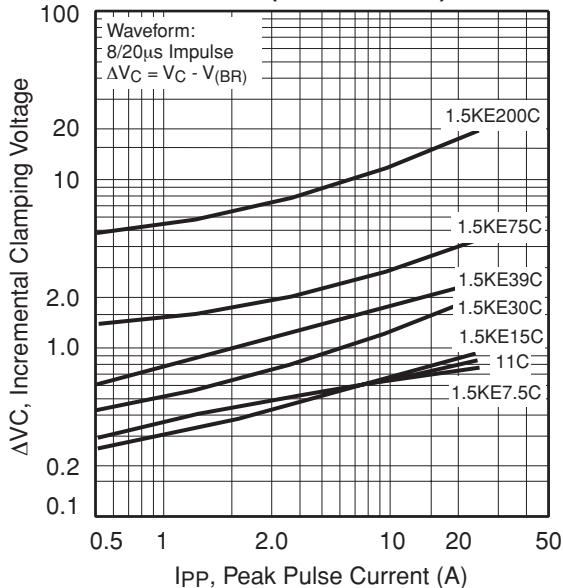
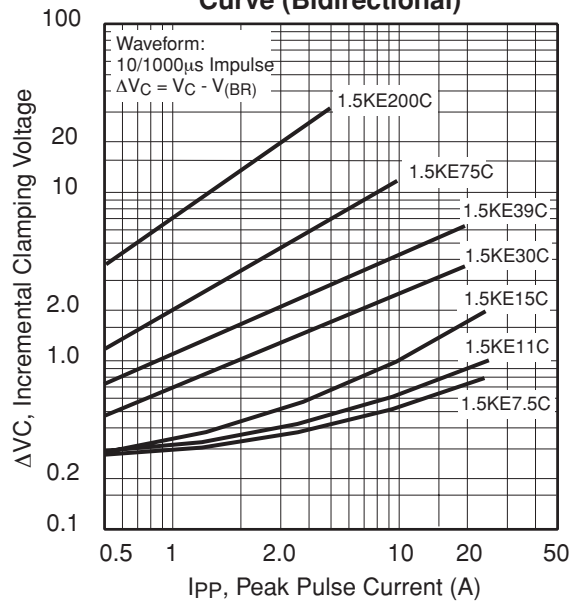

Fig. 10 – Incremental Clamping Voltage Curve (Bidirectional)



1.5KE Series and 1N6267 thru 1N6303A



Vishay Semiconductors
formerly General Semiconductor

Ratings and Characteristic Curves ($T_A = 25^\circ\text{C}$ unless otherwise noted)

Fig. 11 – Instantaneous Forward Voltage Characteristics Curve

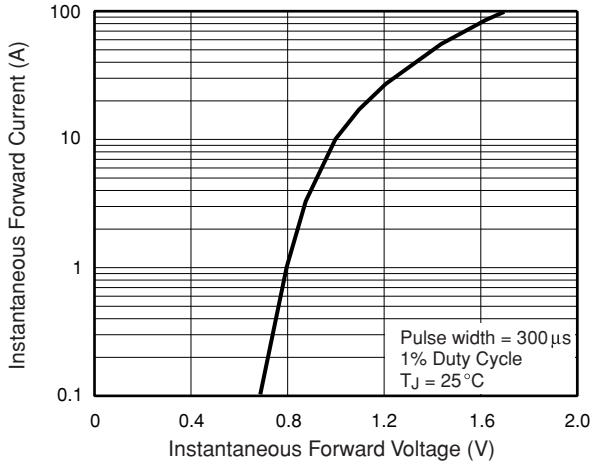

Fig. 12 – Typical Transient Thermal Impedance

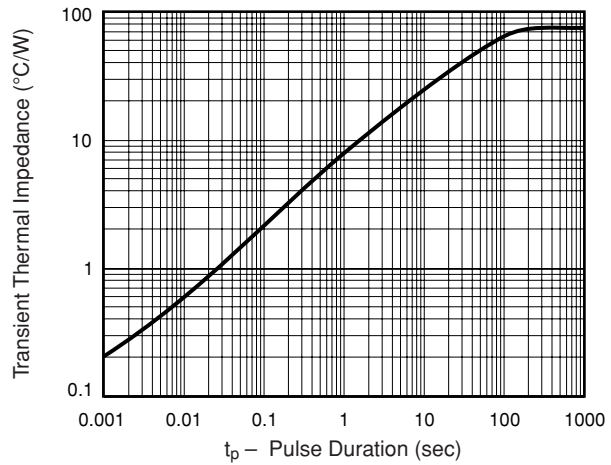

Fig. 13 – Typical Reverse Leakage Characteristics

