



# NJM2367

## ■ABSOLUTE MAXIMUM RATINGS (Ta=25°C)

PARAMETER	SYMBOL	RATINGS	UNIT
Maximum Supply Voltage	V <sup>+</sup>	40	V
Switch Output Voltage	V <sub>O (SWITCH)</sub>	-0.5 ~ +V <sub>in</sub>	V
Voltage Feedback and Compensation Input Voltage Range	V <sub>FB</sub> , V <sub>COMP</sub>	-0.3 ~ +7.0	V
Power Dissipation	P <sub>D</sub>	TO-220 (5PIN) 16(T <sub>C</sub> ≤ 46°C)	W
Operating Junction Temperature	T <sub>j</sub>	-40 ~ +150	°C
Operating Temperature Range	T <sub>opr</sub>	-40 ~ +85	°C
Storage Temperature Range	T <sub>stg</sub>	-50 ~ +150	°C

## ■THERMAL CHARACTERISTICS

Thermal Resistance	Junction-to-Ambient Temperature	θ <sub>ja</sub>	70	°C/W
	Junction-to-Case	θ <sub>jc</sub>	6.5	

## ■POWER DISSIPATION vs. AMBIENT TEMPERATURE

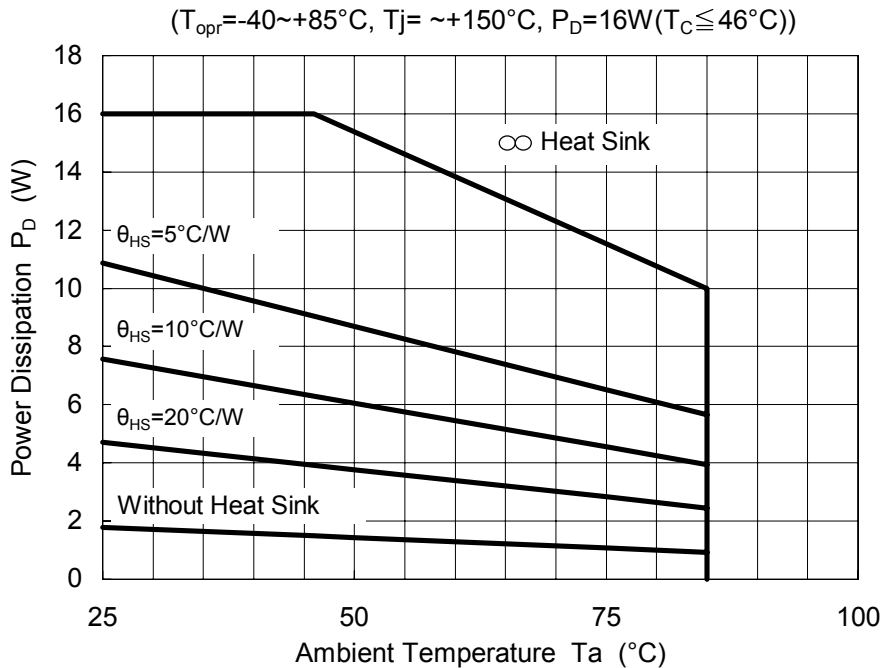

## ■ ELECTRICAL CHARACTERISTICS ( $V^+=12V$ , $T_a=25^\circ C$ )

### OSCILLATOR BLOCK

PARAMETER	SYMBOL	TEST CONDITIONS	MIN.	TYP.	MAX.	UNIT
Frequency	fosc	$V^+=7.5V$	65	72	79	kHz

### ERROR AMPLIFIER BLOCK

PARAMETER	SYMBOL	TEST CONDITIONS	MIN.	TYP.	MAX.	UNIT
Voltage Feedback Input Threshold	$V_{FB(th)}$		4.9	5.0	5.1	V
Line Regulation	REG·Line	$V^+=7.5 \sim 40V$	–	0.03	0.08	%/V
Input Bias Current	$I_B$	$V_{FB}=V_{FB(th)}+0.15V$	–	0.15	1.0	$\mu A$
Ripple Rejection	PSRR	$V^+=10 \sim 20V$	–	80	–	dB
Output Voltage Swing	$V_{OH}$	$I_{source}=75\mu A, V_{FB}=4.7V$	4.2	4.9	–	V
	$V_{OL}$	$I_{sink}=0.4mA, V_{FB}=5.3V$	–	1.6	1.9	V

### PWM COMPARATOR BLOCK

PARAMETER	SYMBOL	TEST CONDITIONS	MIN.	TYP.	MAX.	UNIT
Duty Cycle Maximum Minimum	$DC_{(MAX)}$	$V_{FB}=0V$	–	95	–	%
	$DC_{(MIN)}$	$V_{FB}=5.3V$	0	0	0	%

### SWITCH OUTPUT BLOCK

PARAMETER	SYMBOL	TEST CONDITIONS	MIN.	TYP.	MAX.	UNIT
Output Voltage Saturation	$V_{SAT}$	$V^+=7.5V, I_{source}=5.5A$	–	$V^+-1.5$	$V^+-1.8$	V
OFF-State Leakage	$I_{sw(off)}$	$V^+=40V, SW_{OUT}=0V$	–	0	100	$\mu A$
Current Limit Threshold	$I_{pk(SWITCH)}$	$V^+=7.5V$	5.5	6.5	8.0	A
Switching Times						
Output Voltage Rise Time	tr	$V^+=40V, R_{OUT}=7.7\Omega, V_{FB}=0V$	–	100	–	nS
Output Voltage Fall Time	tf	$V^+=40V, R_{OUT}=7.7\Omega, V_{FB}=0V$	–	50	–	nS

### UNDER VOLTAGE LOCKOUT BLOCK

PARAMETER	SYMBOL	TEST CONDITIONS	MIN.	TYP.	MAX.	UNIT
Startup Threshold	$V_{TH(UVLO)}$	$V^+$ Increasing	5.9	6.3	6.7	V
Hysteresis	$V_{H(UVLO)}$	$V^+$ Decreasing	0.6	0.8	1.0	V

### TOTAL DEVICE

PARAMETER	SYMBOL	TEST CONDITIONS	MIN.	TYP.	MAX.	UNIT
Standby-State Power Supply Current	$I_{CC(stby)}$	$STBY \leq 0.1V$	–	36	100	$\mu A$
Operating-State Power Supply Current	icc	$V^+=40V, V_{FB}=0V$ duty-cycle=MAX	–	40	53	mA

Keep the limit of maximum power dissipation not to operate thermal shutdown.

Low duty cycle pulse test is used to close its junction temperature to ambient temperature.

# NJM2367

## TYPICAL CHARACTERISTICS

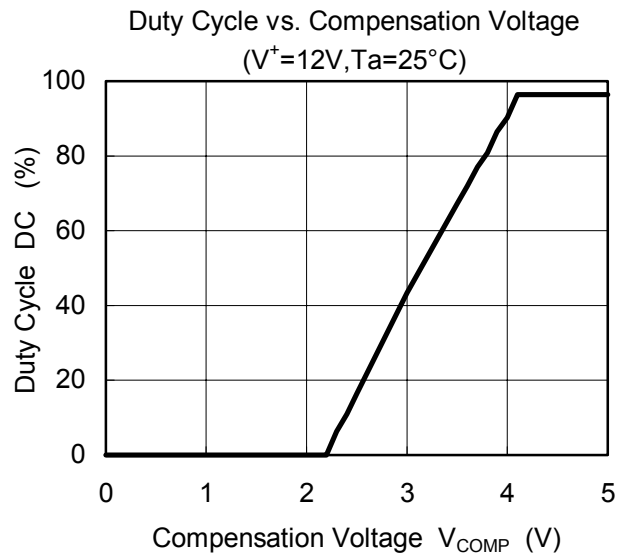
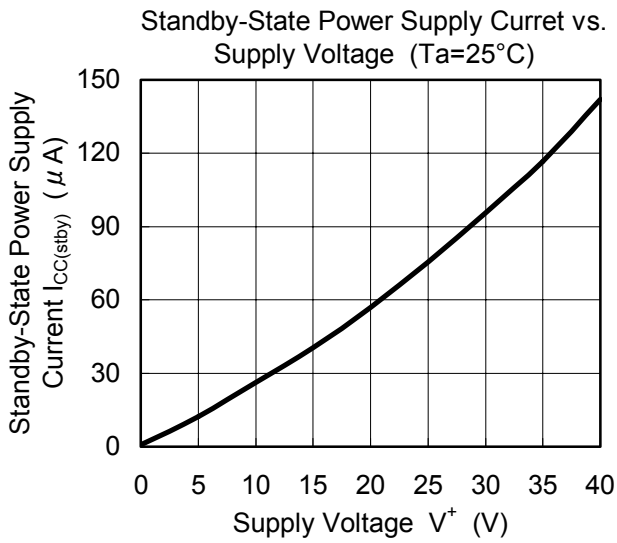
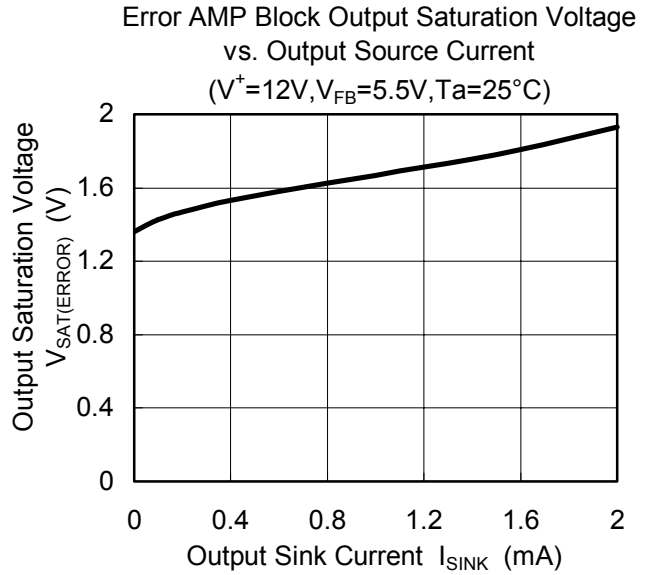
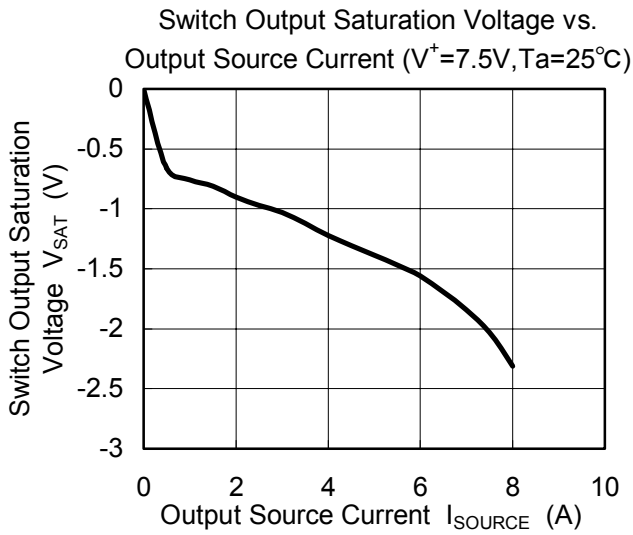

## TYPICAL CHARACTERISTICS

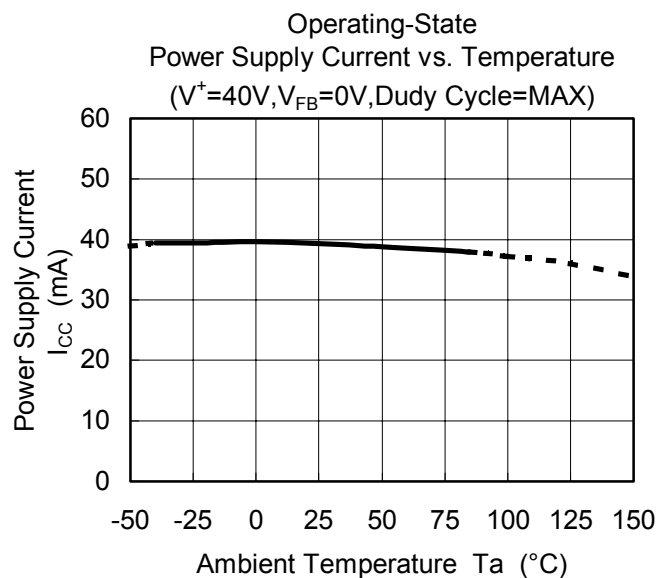
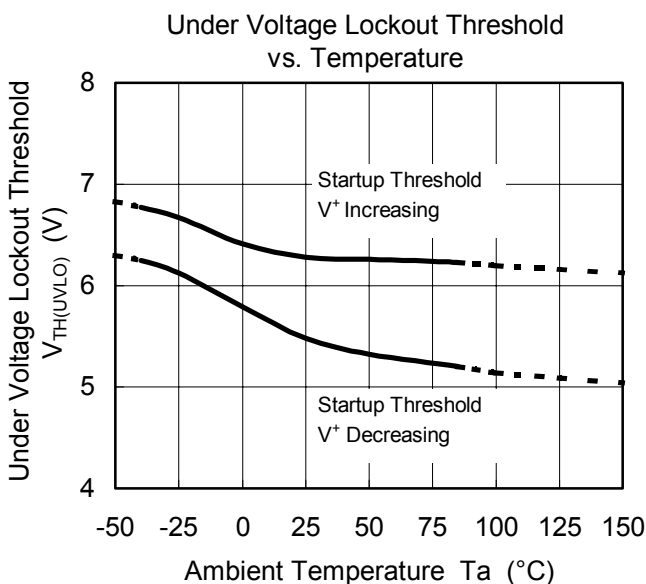
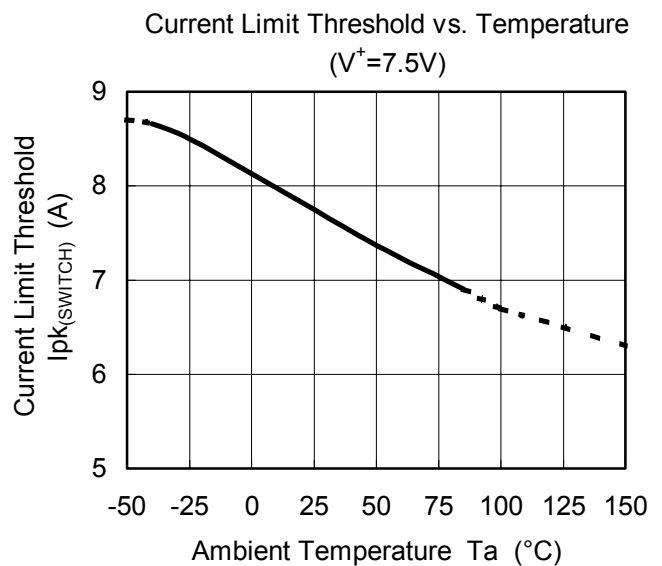
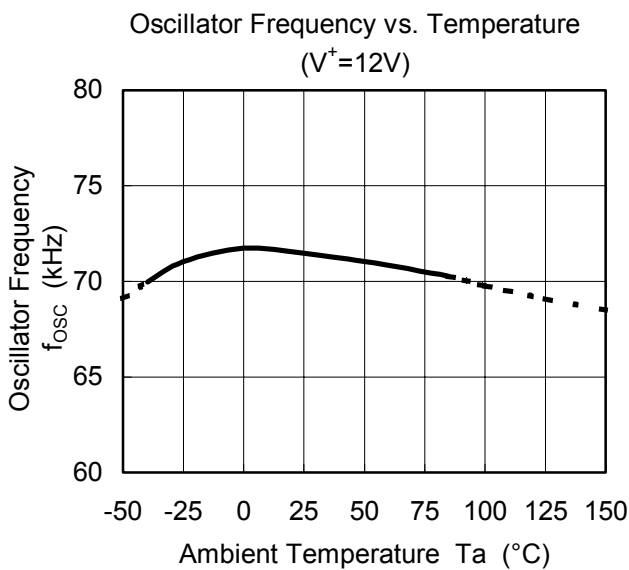
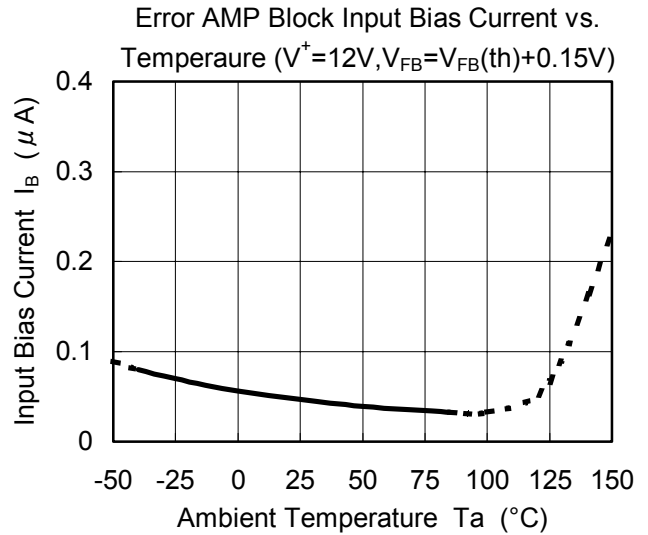
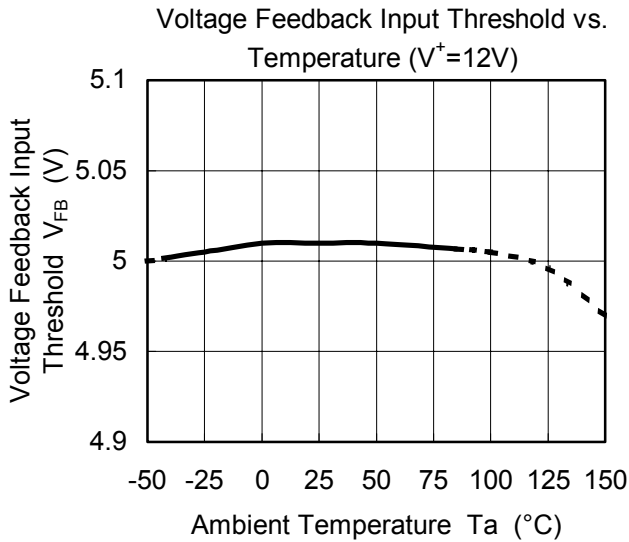

# NJM2367

## ■ TYPICAL APPLICATIONS

### Step-Down Converter

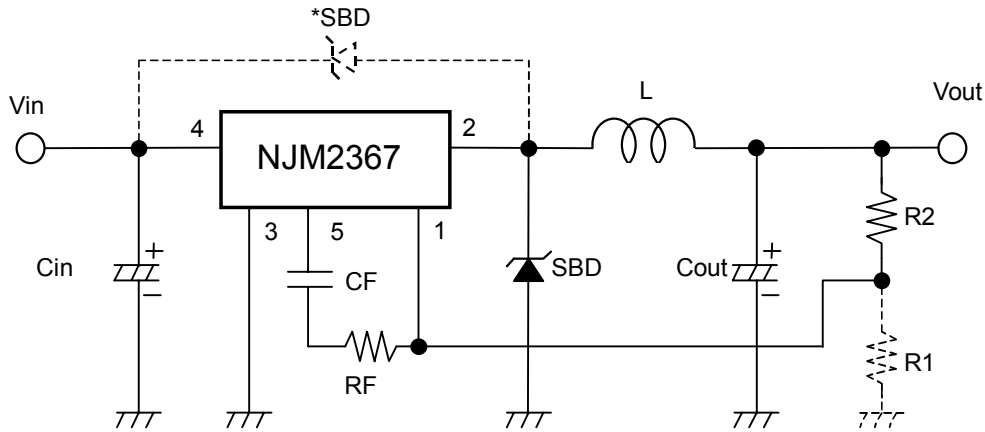

- 1) 5V and higher converter, the application must be connected R1 resistor according to above figure.
- 2) High current converter, the application must be placed Cin capacitor next to NJM2367, which avoid the power-line fluctuation.
- 3) The sharp fluctuation of output load cause reverse voltage for inductance and over the supply-voltage for SW<sub>OUT</sub> terminal. To avoid this problem, the application must be placed SBD between terminal 2 and 4.

## ■ TIMING CHART

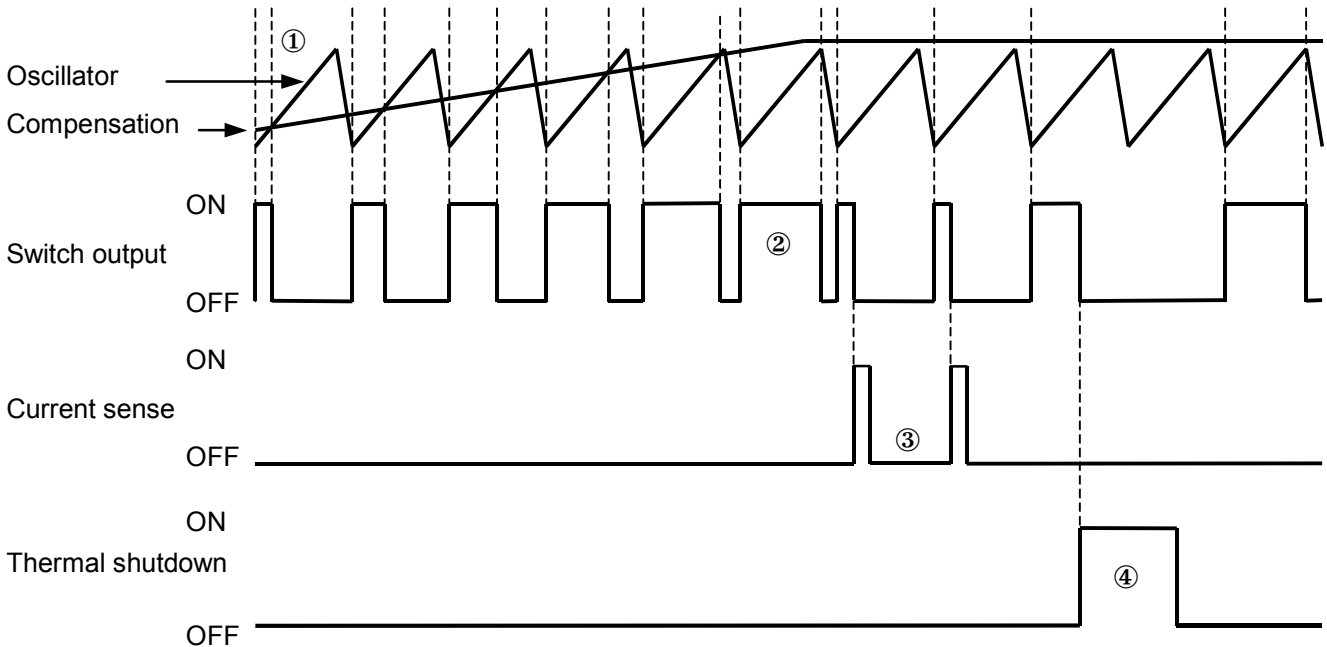

- 1) The NJM2367 generate square waves. The PWM comparator generate PWM signals to compare square waves and compensation voltage.
- 2) The switching duty is maximum 95%.
- 3) Over the 6.5A current, the output switch will be OFF to operate current limit protection. The NJM2367 sense the switching current of power transistor.
- 4) Over the 180°C (T<sub>j</sub>), the switching will be OFF to operate thermal shutdown circuit.

MEMO

[CAUTION]  
The specifications on this databook are only given for information , without any guarantee as regards either mistakes or omissions. The application circuits in this databook are described only to show representative usages of the product and not intended for the guarantee or permission of any right including the industrial rights.