

Designer's™ Data Sheet
SWITCHMODE™
Ultrafast Power Rectifier

POWERTAP™ II Package

Features mesa epitaxial construction with glass passivation. Ideally suited high frequency switching power supplies; free wheeling diodes and polarity protection diodes.

- Stable, High Temperature, Glass Passivated Junction
- Monolithic Dual Die Construction. May be Paralleled for High Current Output

Mechanical Characteristics:

- Case: Molded Epoxy with Metal Heatsink Base
- Weight: 80 grams (approximately)
- Finish: All External Surfaces Corrosion Resistant
- Base Plate Torques: See procedure given in the Package Outline Section
- Shipped 25 units per tray
- Marking: URP20040CT

MURP20040CT

**ULTRAFAST
RECTIFIER
200 AMPERES**

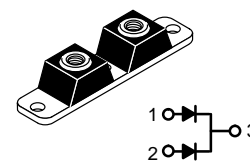

**CASE 357C-03
POWERTAP II**

MAXIMUM RATINGS

Rating	Symbol	Value	Unit
Peak Repetitive Reverse Voltage Working Peak Reverse Voltage DC Blocking Voltage	V_{RRM} V_{RWM} V_R	400	Volts
Average Rectified Forward Current (At Rated V_R , $T_C = 115^\circ\text{C}$)	I_O	100 200	Amps Per Leg Per Package
Peak Repetitive Forward Current (At Rated V_R , Square Wave, 20 kHz, $T_C = 115^\circ\text{C}$)	I_{FRM}	200	Amps Per Leg
Non-Repetitive Peak Surge Current (Surge applied at rated load conditions, halfwave, single phase, 60 Hz)	I_{FSM}	800	Amps Per Package
Storage/Operating Case Temperature	T_{stg}, T_C	-55 to +150	$^\circ\text{C}$
Operating Junction Temperature	T_J	-55 to +175	$^\circ\text{C}$

THERMAL CHARACTERISTICS

Thermal Resistance — Junction-to-Case	Per Leg	$R_{\theta jc}$	0.5	$^\circ\text{C/W}$
---------------------------------------	---------	-----------------	-----	--------------------

ELECTRICAL CHARACTERISTICS

Maximum Instantaneous Forward Voltage (1), see Figure 2 ($I_F = 100\text{ A}$) ($I_F = 200\text{ A}$)	Per Leg	V_F	$T_J = 25^\circ\text{C}$	$T_J = 100^\circ\text{C}$	Volts
			1.3	1.2	
Maximum Instantaneous Reverse Current, see Figure 4 ($V_R = 400\text{ V}$) ($V_R = 200\text{ V}$)	Per Leg	I_R	$T_J = 25^\circ\text{C}$	$T_J = 100^\circ\text{C}$	μA
			5.0	193	
Typical Reverse Recovery Time (2) ($I_F = 1.0\text{ A}$, $di/dt = 50\text{ A}/\mu\text{s}$)	Per Leg	T_{RR}	$T_J = 25^\circ\text{C}$		ns
			85		
Typical Peak Reverse Recovery Current ($I_F = 1.0\text{ A}$, $di/dt = 50\text{ A}/\mu\text{s}$)	Per Leg	I_{RM}	$T_J = 25^\circ\text{C}$		Amps
			-3.0		

(1) Pulse Test: Pulse Width $\leq 250\ \mu\text{s}$, Duty Cycle $\leq 2\%$.

(2) T_{RR} measured projecting from 25% of I_{RM} to ground.

POWERTAP and SWITCHMODE are trademarks of Motorola, Inc.

This document contains information on a product under development. Motorola reserves the right to change or discontinue this product without notice.

MURP20040CT

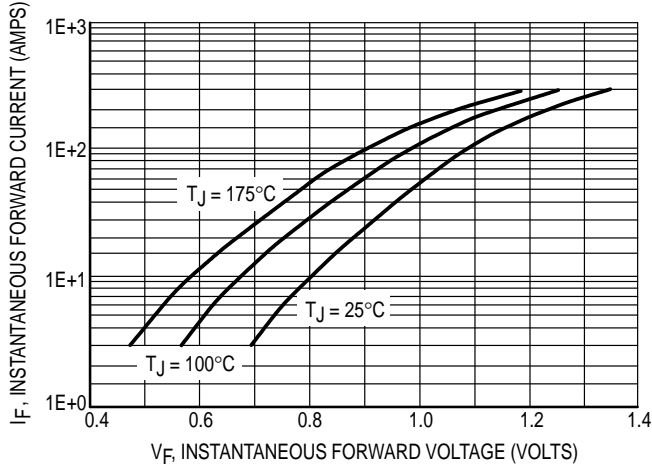

Figure 1. Typical Forward Voltage

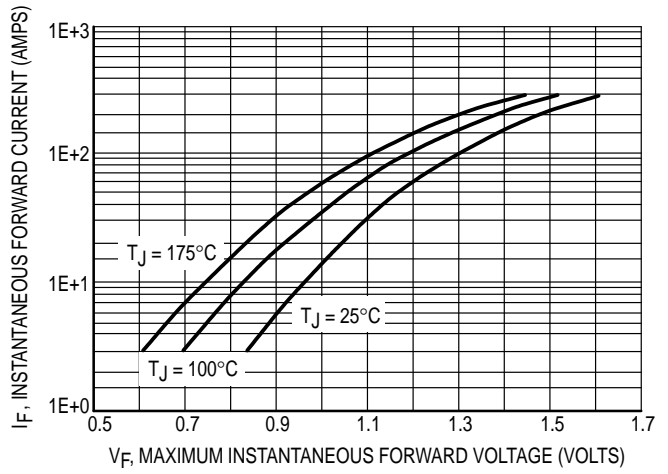

Figure 2. Maximum Forward Voltage

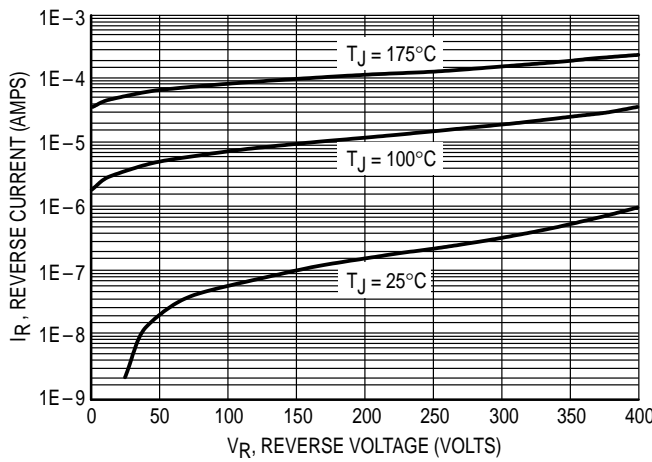

Figure 3. Typical Reverse Current

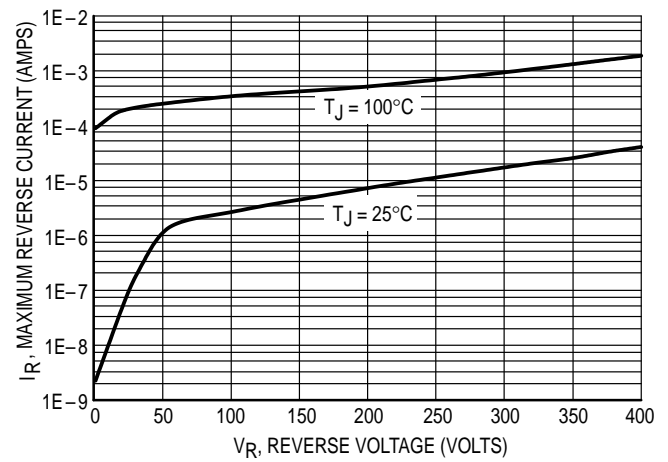

Figure 4. Maximum Reverse Current

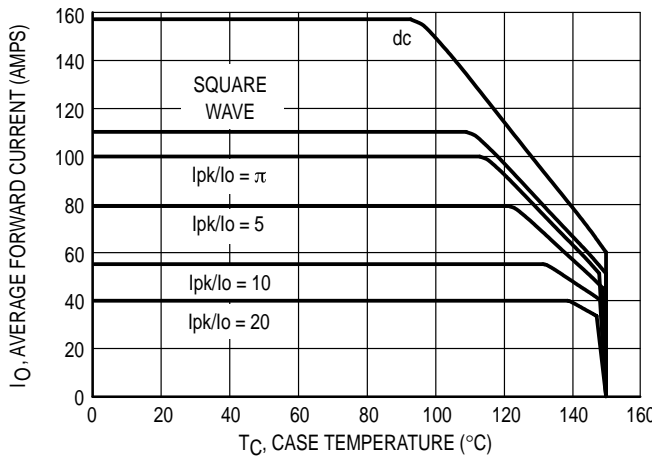

Figure 5. Current Derating (PER LEG)

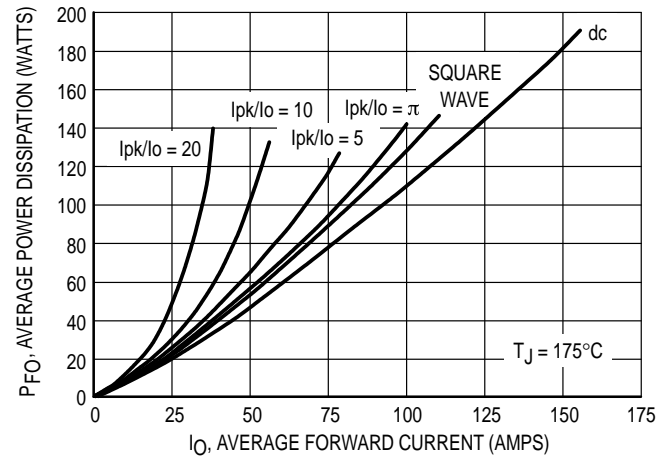

Figure 6. Forward Power Dissipation (PER LEG)

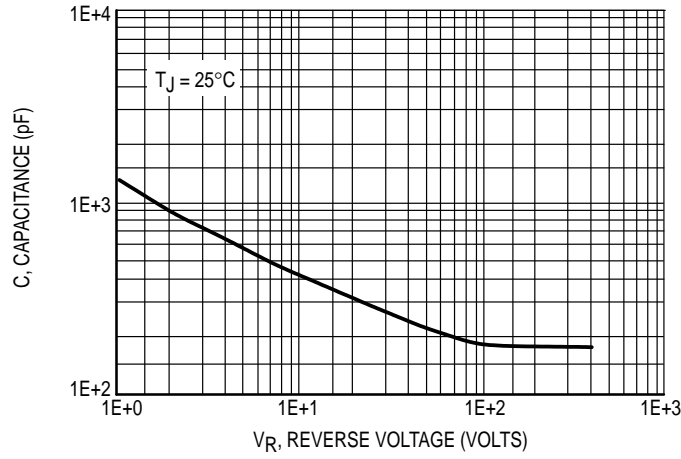

Figure 7. Capacitance

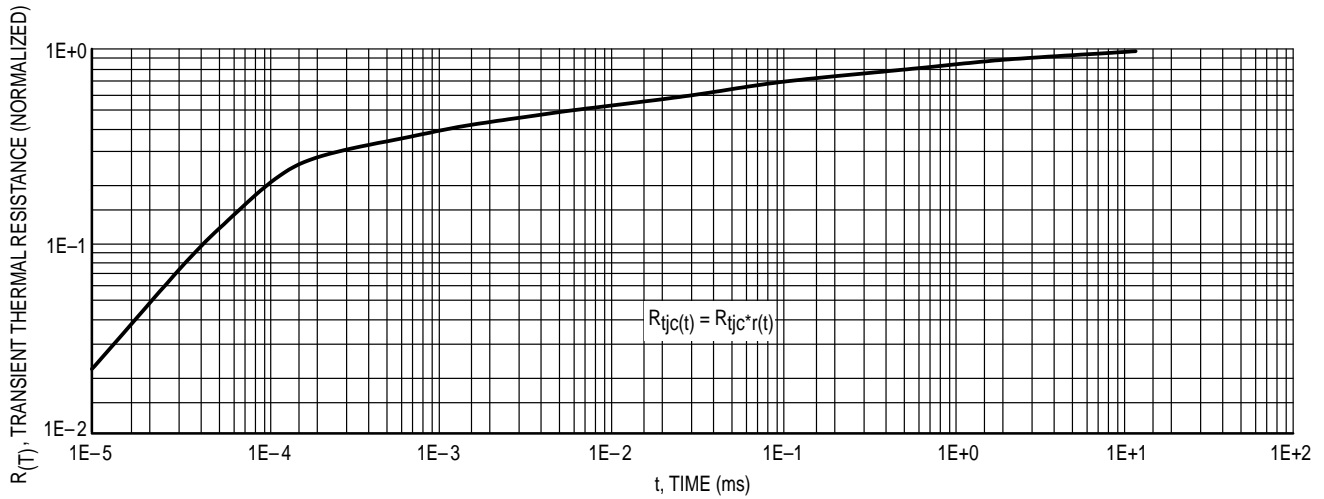

Figure 8. Thermal Response

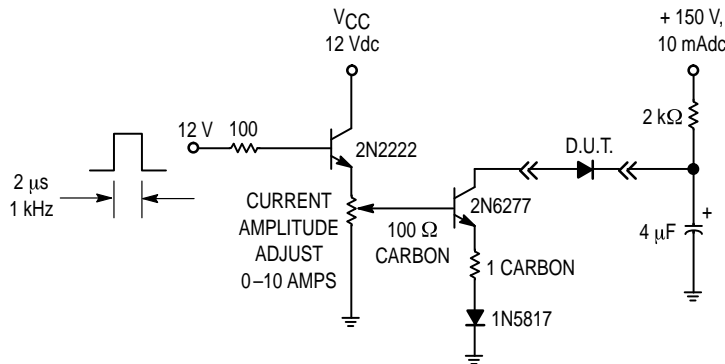

Figure 9. Test Circuit for Repetitive Reverse Current

MURP20040CT

MAXIMUM MECHANICAL RATINGS

Terminal Penetration:	0.235 max
Terminal Torque:	70 in-lb max
Mounting Torque — Outside Holes:	70 in-lb max
Mounting Torque — Center Hole:	8–10 in-lb max
Seating Plane Flatness	1 mil per in. (between mounting holes)

POWERTAP MECHANICAL DATA APPLIES OVER OPERATING TEMPERATURE

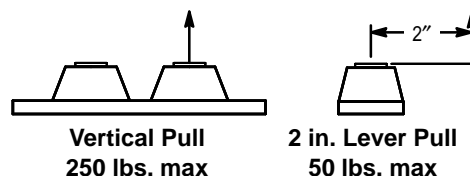

Note: While the POWERTAP is capable of sustaining these vertical and levered tensions, the intimate contact between POWERTAP and heat sink may be lost. This could lead to thermal runaway. The use of very flexible leads is recommended for the anode connections. Use of thermal grease is highly recommended.

MOUNTING PROCEDURE

The POWERTAP package requires special mounting considerations because of the long longitudinal axis of the copper heat sink. It is important to follow the proper tightening sequence to avoid warping the heat sink, which can reduce thermal contact between the POWERTAP and heat sink.

STEP 1:

Locate the POWERTAP on the heat sink and start mounting bolts into the threads by hand (2 or 3 turns).

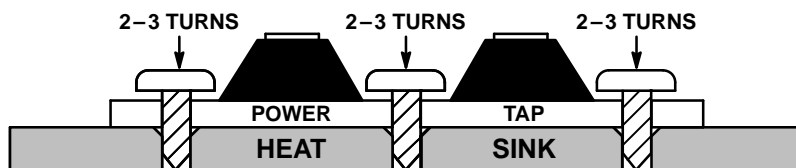

STEP 2:

Finger tighten the center bolt. The bolt may catch on the threads of the heat sink so it is important to make sure the face of the bolt or washer is in contact with the surface of the POWERTAP.

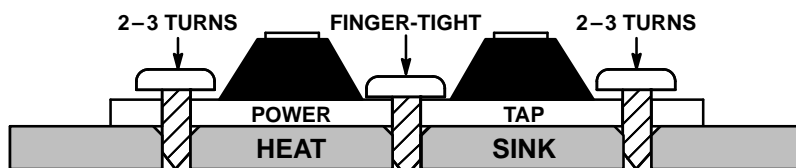

STEP 3:

Tighten each of the end bolts between 5 to 10 in-lb.

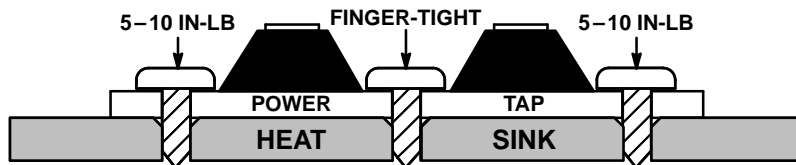

STEP 4:

Tighten the center bolt between 8 to 10 in-lb.

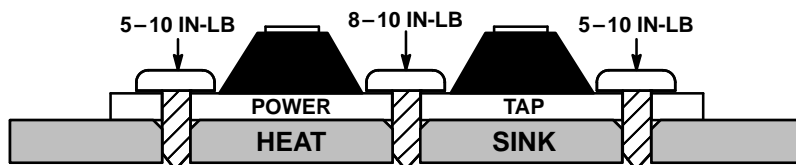

STEP 5:

Finally, tighten the end bolts to 70 in-lb.

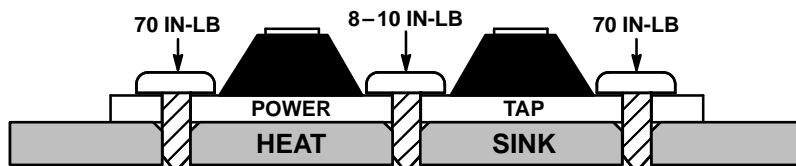

PACKAGE DIMENSIONS

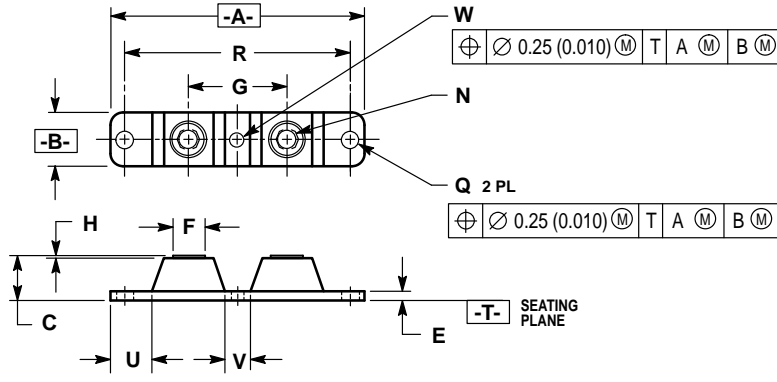

- NOTES:
 1. DIMENSIONING AND TOLERANCING PER ANSI Y14.5M, 1982.
 2. CONTROLLING DIMENSION: INCH.
 3. TERMINAL PENETRATION: 5.97 (0.235) MAXIMUM.

DIM	INCHES		MILLIMETERS	
	MIN	MAX	MIN	MAX
A	3.450	3.635	87.63	92.33
B	0.700	0.810	17.78	20.57
C	0.615	0.640	15.53	16.26
E	0.120	0.130	3.05	3.30
F	0.435	0.445	11.05	11.30
G	1.370	1.380	34.80	35.05
H	0.007	0.030	0.18	0.76
N	1/4-20UNC 2B		1/4-20UNC 2B	
Q	0.270	0.285	6.86	7.32
R	31.50 BSC		80.01 BSC	
U	0.600	0.630	15.24	16.00
V	0.330	0.375	8.39	9.52
W	0.170	0.190	4.32	4.82

CASE 357C-03
 ISSUE C

Motorola reserves the right to make changes without further notice to any products herein. Motorola makes no warranty, representation or guarantee regarding the suitability of its products for any particular purpose, nor does Motorola assume any liability arising out of the application or use of any product or circuit, and specifically disclaims any and all liability, including without limitation consequential or incidental damages. "Typical" parameters can and do vary in different applications. All operating parameters, including "Typicals" must be validated for each customer application by customer's technical experts. Motorola does not convey any license under its patent rights nor the rights of others. Motorola products are not designed, intended, or authorized for use as components in systems intended for surgical implant into the body, or other applications intended to support or sustain life, or for any other application in which the failure of the Motorola product could create a situation where personal injury or death may occur. Should Buyer purchase or use Motorola products for any such unintended or unauthorized application, Buyer shall indemnify and hold Motorola and its officers, employees, subsidiaries, affiliates, and distributors harmless against all claims, costs, damages, and expenses, and reasonable attorney fees arising out of, directly or indirectly, any claim of personal injury or death associated with such unintended or unauthorized use, even if such claim alleges that Motorola was negligent regarding the design or manufacture of the part. Motorola and  are registered trademarks of Motorola, Inc. Motorola, Inc. is an Equal Opportunity/Affirmative Action Employer.

How to reach us:

USA / EUROPE: Motorola Literature Distribution;
P.O. Box 20912; Phoenix, Arizona 85036. 1-800-441-2447

JAPAN: Nippon Motorola Ltd.; Tatsumi-SPD-JLDC, Toshikatsu Otsuki,
6F Seibu-Butsuryu-Center, 3-14-2 Tatsumi Koto-Ku, Tokyo 135, Japan. 03-3521-8315

MFAX: RMFAX0@email.sps.mot.com - TOUCHTONE (602) 244-6609
INTERNET: <http://Design-NET.com>

HONG KONG: Motorola Semiconductors H.K. Ltd.; 8B Tai Ping Industrial Park,
51 Ting Kok Road, Tai Po, N.T., Hong Kong. 852-26629298



Copyright © Each Manufacturing Company.

All Datasheets cannot be modified without permission.

This datasheet has been download from :

www.AllDataSheet.com

100% Free DataSheet Search Site.

Free Download.

No Register.

Fast Search System.

www.AllDataSheet.com