



# MURB820PbF MUR820-1PbF

## Ultrafast Rectifier

### Features

- Ultrafast Recovery Time
- Low Forward Voltage Drop
- Low Leakage Current
- 175°C Operating Junction Temperature
- Lead-Free ("PbF" suffix)

|                    |
|--------------------|
| $t_{rr} = 25ns$    |
| $I_{F(AV)} = 8Amp$ |
| $V_R = 200V$       |

### Description/ Applications

International Rectifier's MUR.. series are the state of the art Ultra fast recovery rectifiers specifically designed with optimized performance of forward voltage drop and ultra fast recovery time.



The planar structure and the platinum doped life time control, guarantee the best overall performance, ruggedness and reliability characteristics.

These devices are intended for use in the output rectification stage of SMPS, UPS, DC-DC converters as well as free-wheeling diode in low voltage inverters and chopper motor drives.

Their extremely optimized stored charge and low recovery current minimize the switching losses and reduce over dissipation in the switching element and snubbers.

### Absolute Maximum Ratings

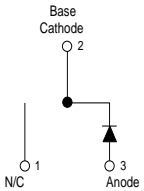
| Parameters                                                                                           | Max        | Units      |
|------------------------------------------------------------------------------------------------------|------------|------------|
| $V_{RRM}$ Peak Repetitive Peak Reverse Voltage                                                       | 200        | V          |
| $I_{F(AV)}$ Average Rectified Forward Current<br>Total Device, (Rated $V_R$ ), $T_C = 150^\circ C$   | 8          | A          |
| $I_{FSM}$ Non Repetitive Peak Surge Current                                                          | 100        |            |
| $I_{FM}$ Peak Repetitive Forward Current<br>(Rated $V_R$ , Square wave, 20 KHz), $T_C = 150^\circ C$ | 16         |            |
| $T_J, T_{STG}$ Operating Junction and Storage Temperatures                                           | -65 to 175 | $^\circ C$ |

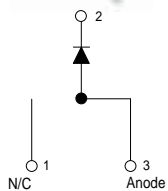
| Case Styles                                                                                                                                                                                                       |                                                                                                                                                                                                             |
|-------------------------------------------------------------------------------------------------------------------------------------------------------------------------------------------------------------------|-------------------------------------------------------------------------------------------------------------------------------------------------------------------------------------------------------------|
| <p>MURB820PbF</p>   <p>D<sup>2</sup>PAK</p> | <p>MURB820-1PbF</p>   <p>TO-262</p> |

**Electrical Characteristics @ T<sub>J</sub> = 25°C (unless otherwise specified)**

| Parameters                       | Min | Typ | Max   | Units | Test Conditions                                               |
|----------------------------------|-----|-----|-------|-------|---------------------------------------------------------------|
| V <sub>BR</sub> , V <sub>F</sub> | 200 | -   | -     | V     | I <sub>R</sub> = 100μA                                        |
| V <sub>F</sub>                   | -   | -   | 0.975 | V     | I <sub>F</sub> = 8A                                           |
|                                  |     |     | 0.895 | V     | I <sub>F</sub> = 8A, T <sub>J</sub> = 150°C                   |
| I <sub>R</sub>                   | -   | -   | 5     | μA    | V <sub>R</sub> = V <sub>R</sub> Rated                         |
|                                  |     |     | 250   | μA    | T <sub>J</sub> = 150°C, V <sub>R</sub> = V <sub>R</sub> Rated |
| C <sub>T</sub>                   | -   | 25  | -     | pF    | V <sub>R</sub> = 200V                                         |
| L <sub>S</sub>                   | -   | 8.0 | -     | nH    | Measured lead to lead 5mm from package body                   |

**Dynamic Recovery Characteristics @ T<sub>J</sub> = 25°C (unless otherwise specified)**

| Parameters       | Min | Typ | Max | Units | Test Conditions                                                           |
|------------------|-----|-----|-----|-------|---------------------------------------------------------------------------|
| t <sub>rr</sub>  | -   | -   | 35  | ns    | I <sub>F</sub> = 1.0A, di <sub>F</sub> /dt = 50A/μs, V <sub>R</sub> = 30V |
|                  |     |     | 25  |       | I <sub>F</sub> = 0.5A, I <sub>R</sub> = 1.0A, I <sub>REC</sub> = 0.25A    |
|                  |     |     | 20  |       | T <sub>J</sub> = 25°C                                                     |
|                  |     |     | 34  |       | T <sub>J</sub> = 125°C                                                    |
| I <sub>RRM</sub> | -   | 1.7 | -   | A     | T <sub>J</sub> = 25°C                                                     |
|                  |     |     |     |       | 4.2                                                                       |
| Q <sub>rr</sub>  | -   | 23  | -   | nC    | T <sub>J</sub> = 25°C                                                     |
|                  |     |     |     |       | 75                                                                        |

I<sub>F</sub> = 8A  
V<sub>R</sub> = 160V  
di<sub>F</sub>/dt = 200A/μs

**Thermal - Mechanical Characteristics**

| Parameters                     | Min       | Typ  | Max                           | Units  |
|--------------------------------|-----------|------|-------------------------------|--------|
| T <sub>J</sub>                 | - 65      | -    | 175                           | °C     |
| T <sub>Stg</sub>               | - 65      | -    | 175                           |        |
| R <sub>thJC</sub>              | -         | -    | 3.0                           | °C/ W  |
| R <sub>thJA</sub>              | -         | -    | 50                            |        |
| R <sub>thCS</sub> <sup>①</sup> | -         | 0.5  | -                             |        |
| Wt                             | -         | 2.0  | -                             | g      |
|                                |           | 0.07 |                               | (oz)   |
| Mounting Torque                | 6.0       | -    | 12                            | Kg-cm  |
|                                | 5.0       | -    | 10                            | lbf.in |
| Device Marking                 | MURB820   |      | Case style D <sup>2</sup> Pak |        |
|                                | MURB820-1 |      | Case style TO-262             |        |

① Mounting Surface, Flat, Smooth and Greased

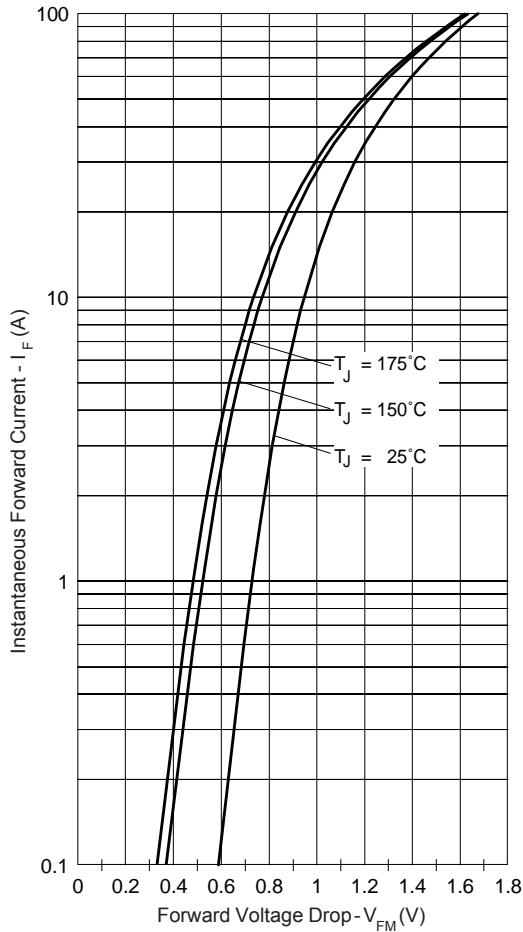

Fig. 1 - Typical Forward Voltage Drop Characteristics

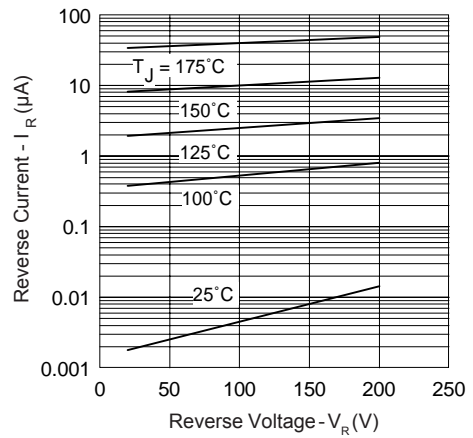

Fig. 2 - Typical Values Of Reverse Current Vs. Reverse Voltage

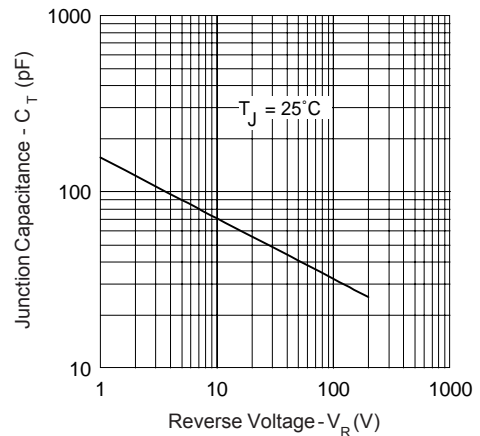

Fig. 3 - Typical Junction Capacitance Vs. Reverse Voltage

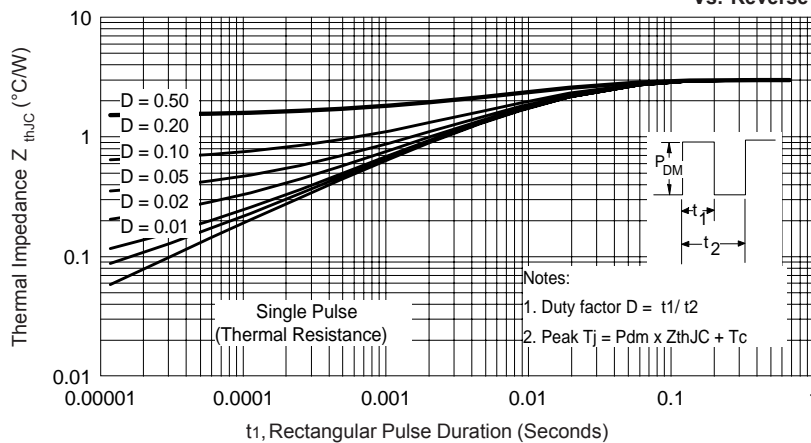

Fig. 4 - Max. Thermal Impedance  $Z_{thJC}$  Characteristics

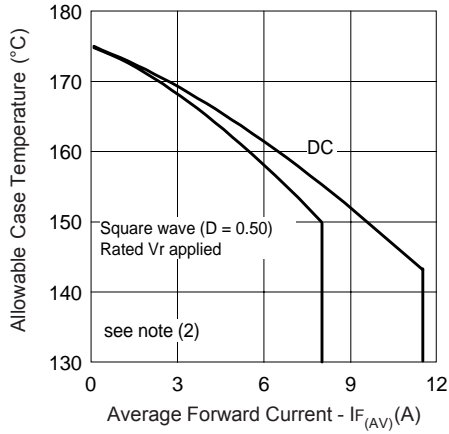

Fig. 5 - Max. Allowable Case Temperature Vs. Average Forward Current

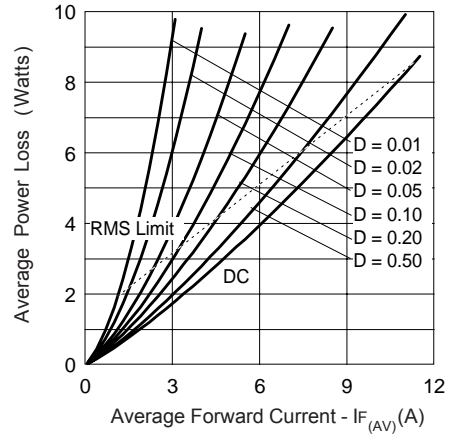

Fig. 6 - Forward Power Loss Characteristics

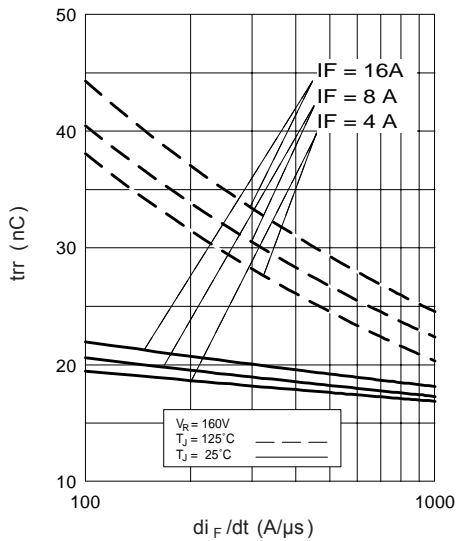

Fig. 7 - Typical Reverse Recovery vs.  $di_F/dt$

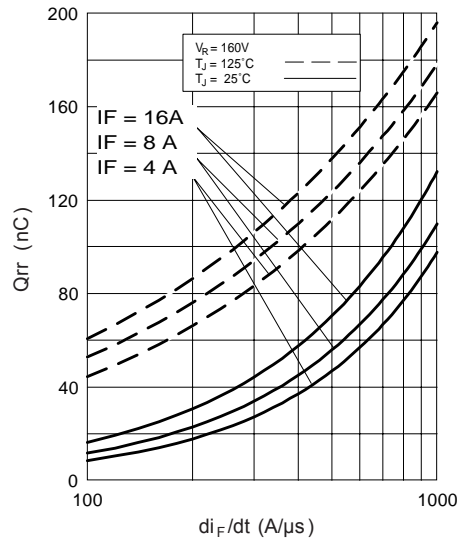

Fig. 8 - Typical Stored Charge vs.  $di_F/dt$

(2) Formula used:  $T_C = T_J - (Pd + Pd_{REV}) \times R_{thJC}$ ;

$Pd$  = Forward Power Loss =  $I_{F(AV)} \times V_{FM} @ (I_{F(AV)}/D)$  (see Fig. 6);

$Pd_{REV}$  = Inverse Power Loss =  $V_{R1} \times I_R (1-D)$ ;  $I_R @ V_{R1}$  = rated  $V_R$

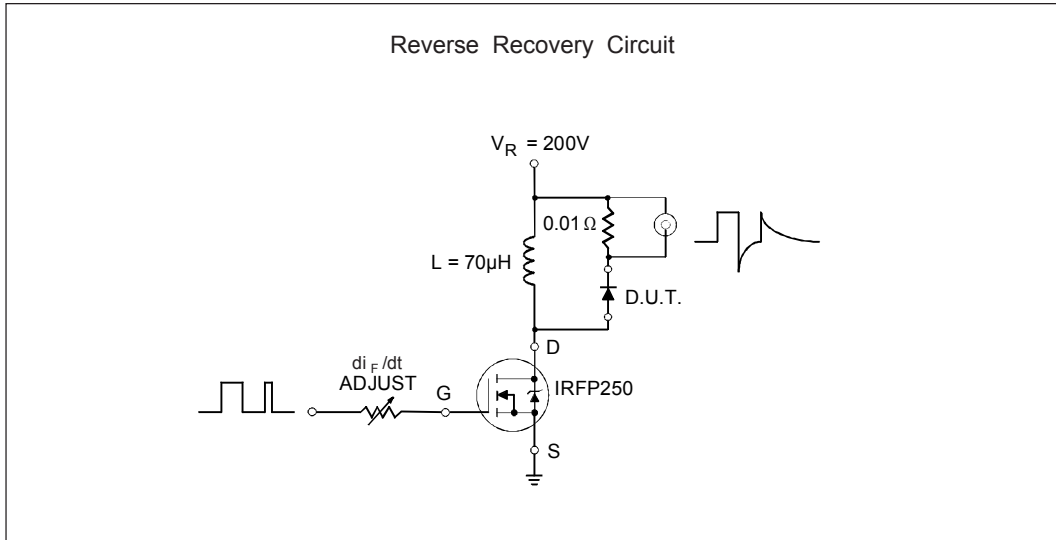

Fig. 9- Reverse Recovery Parameter Test Circuit

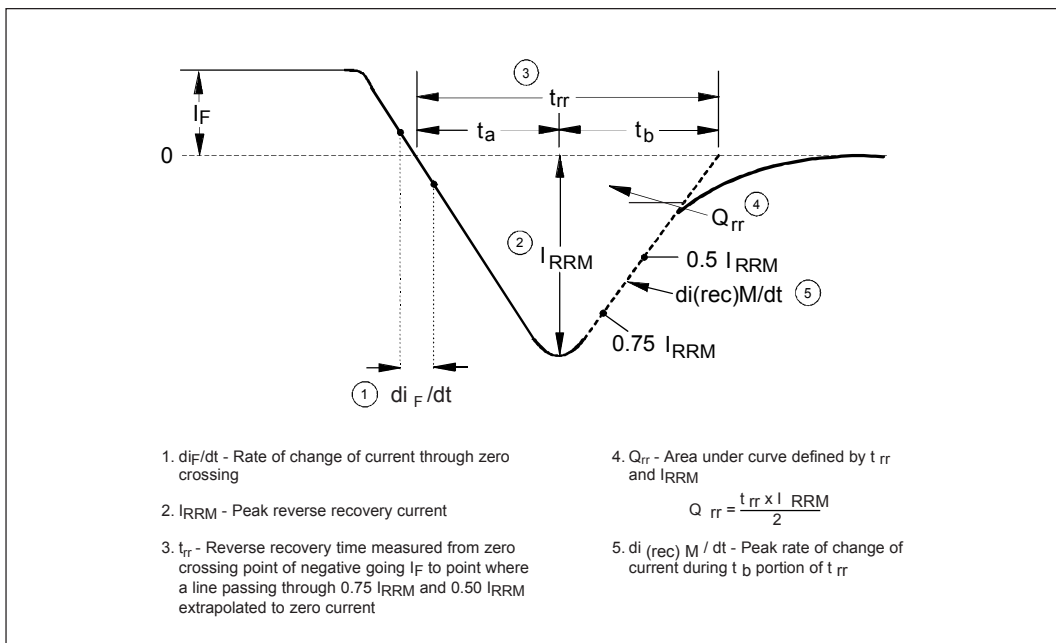
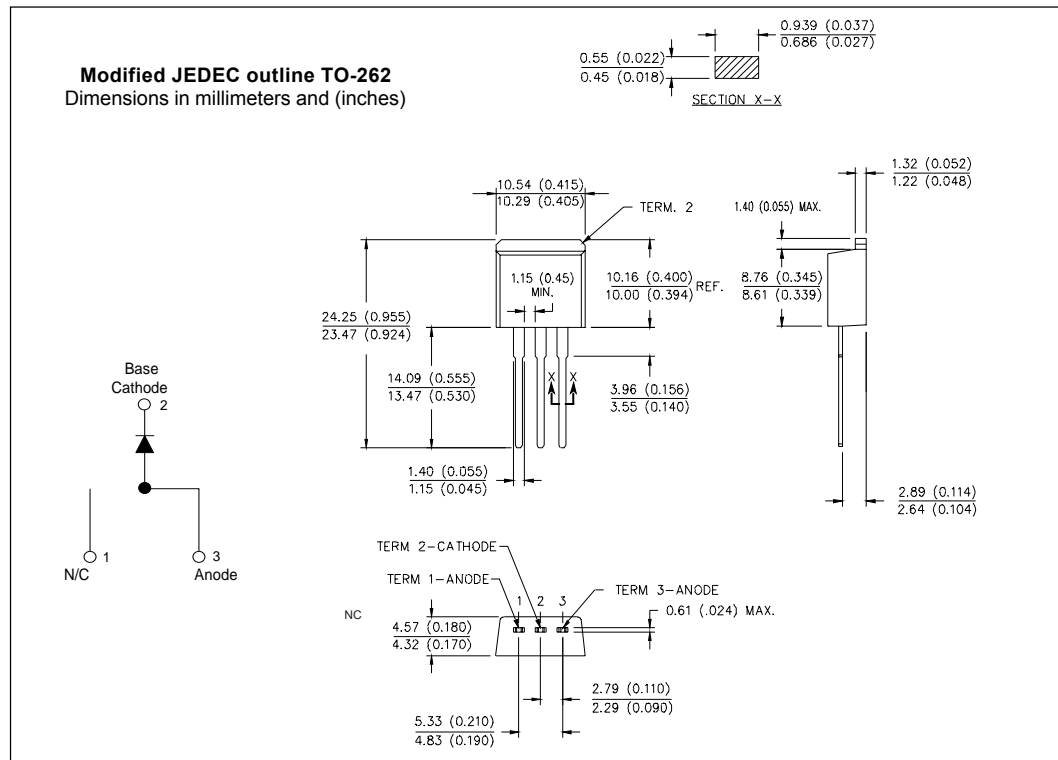
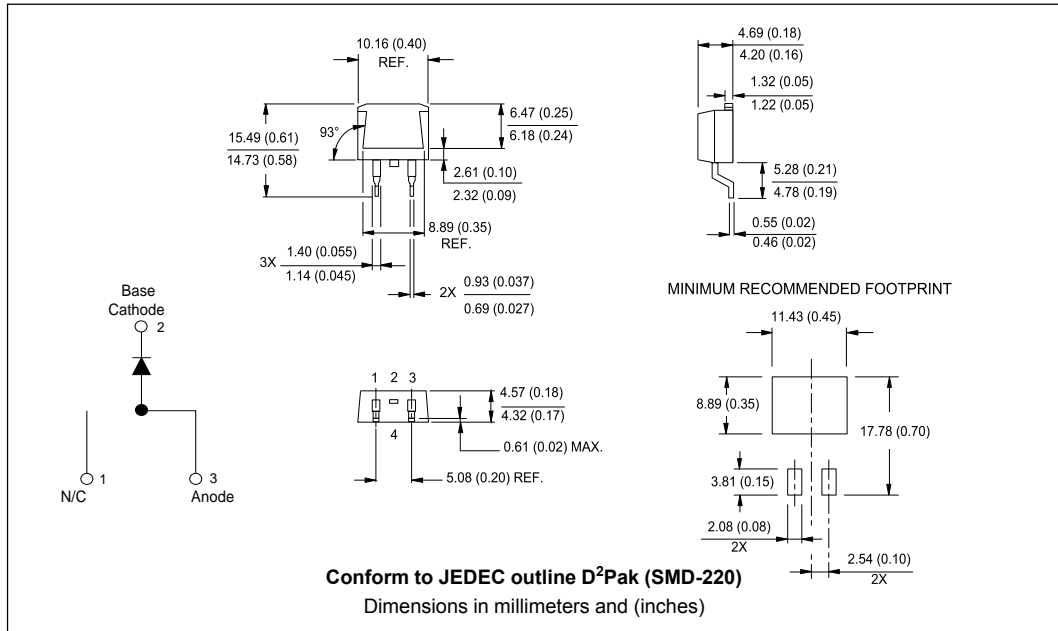

Fig. 10 - Reverse Recovery Waveform and Definitions

Outlines Table



Part Marking Information

**D<sup>2</sup>PAK**

EXAMPLE: THIS IS A MURB820  
 LOT CODE 8024  
 ASSEMBLED ON WW 02, 2000

Note: "P" in assembly line position indicates "Lead-Free"

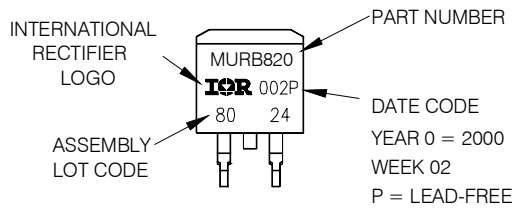

**TO-262**

EXAMPLE: THIS IS A MURB820-1  
 LOT CODE 8024  
 ASSEMBLED ON WW 02, 2000

Note: "P" in assembly line position indicates "Lead-Free"

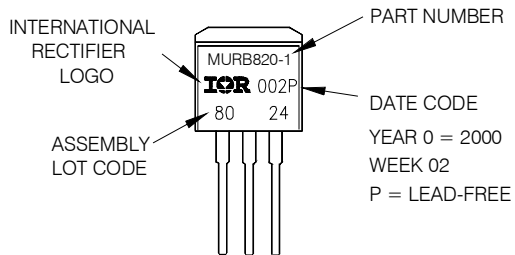

Tape & Reel Information

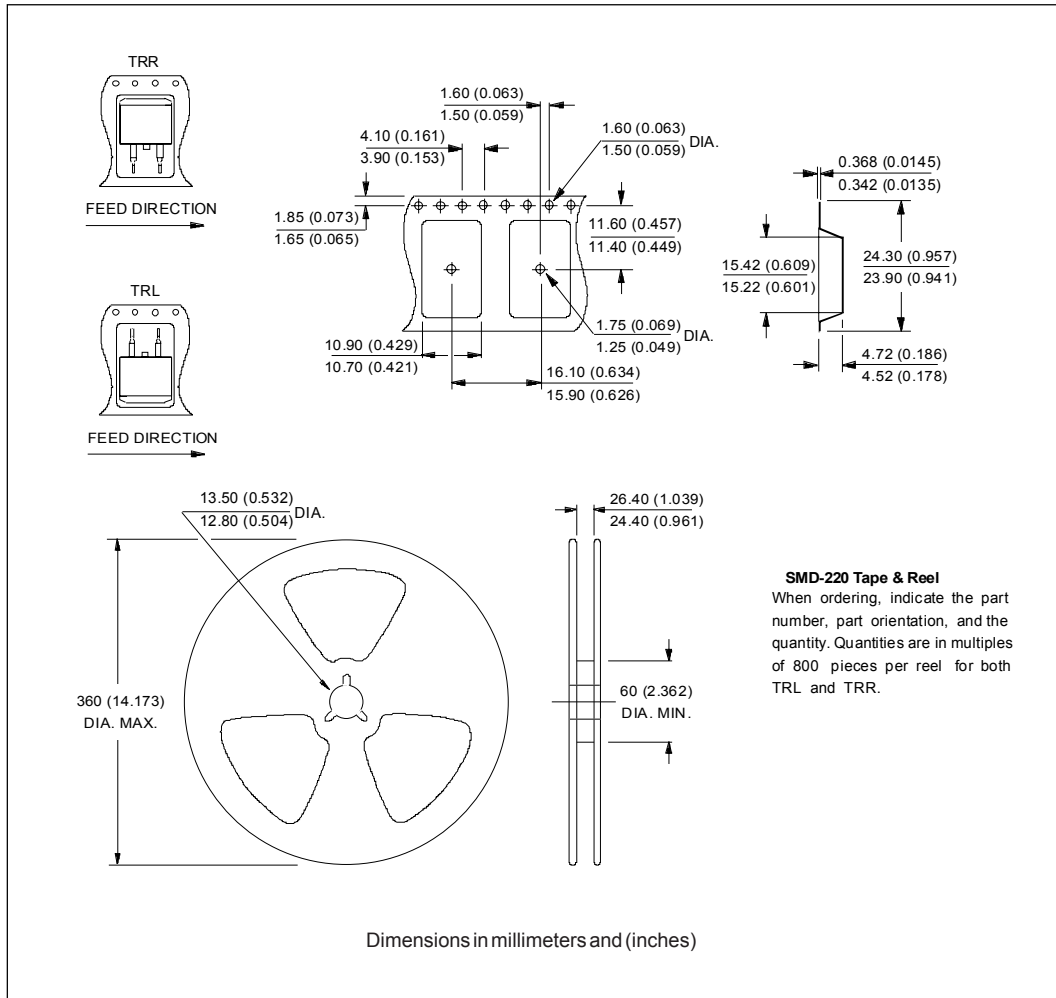

**SMD-220 Tape & Reel**  
 When ordering, indicate the part number, part orientation, and the quantity. Quantities are in multiples of 800 pieces per reel for both TRL and TRR.

Ordering Information Table

| Device Code | MUR | B                                                                                                                                                                                                                                          | 8 | 20 | CT | -1 | TRL | PbF |
|-------------|-----|--------------------------------------------------------------------------------------------------------------------------------------------------------------------------------------------------------------------------------------------|---|----|----|----|-----|-----|
|             | ①   | ②                                                                                                                                                                                                                                          | ③ | ④  | ⑤  | ⑥  | ⑦   | ⑧   |
| <b>1</b>    | -   | Ultrafast MUR Series                                                                                                                                                                                                                       |   |    |    |    |     |     |
| <b>2</b>    | -   | B = D <sup>2</sup> Pak/ TO-262                                                                                                                                                                                                             |   |    |    |    |     |     |
| <b>3</b>    | -   | Current Rating (8 = 8A)                                                                                                                                                                                                                    |   |    |    |    |     |     |
| <b>4</b>    | -   | Voltage Rating (20 = 200V)                                                                                                                                                                                                                 |   |    |    |    |     |     |
| <b>5</b>    | -   | CT = Center Tap (Dual) TO-220 /D <sup>2</sup> PAK/ TO-262                                                                                                                                                                                  |   |    |    |    |     |     |
| <b>6</b>    | -   | -1 = TO-262                                                                                                                                                                                                                                |   |    |    |    |     |     |
| <b>7</b>    | -   | <ul style="list-style-type: none"> <li>• none = Tube (50 pieces)</li> <li>• TRL = Tape &amp; Reel (Left Oriented, for D<sup>2</sup>PAK package)</li> <li>• TRR = Tape &amp; Reel (Right Oriented, for D<sup>2</sup>PAK package)</li> </ul> |   |    |    |    |     |     |
| <b>8</b>    | -   | <ul style="list-style-type: none"> <li>• none = Standard Production</li> <li>• PbF = Lead-Free</li> </ul>                                                                                                                                  |   |    |    |    |     |     |

Data and specifications subject to change without notice.  
 This product has been designed and qualified for Industrial Level and Lead-Free.  
 Qualification Standards can be found on IR's Web site.

MURB820PbF, MURB820-1PbF

Bulletin PD-21085 08/05

International  
**IOR** Rectifier

Data and specifications subject to change without notice.  
This product has been designed and qualified for Industrial Level and Lead-Free.  
Qualification Standards can be found on IR's Web site.

International  
**IOR** Rectifier

**IR WORLD HEADQUARTERS:** 233 Kansas St., El Segundo, California 90245, USA Tel: (310) 252-7105  
TAC Fax: (310) 252-7309  
Visit us at [www.irf.com](http://www.irf.com) for sales contact information. 08/05