

JR SERIES SHELL SIZE 13-25 ALUMINUM CONNECTORS

Scope

There is a Japanese standard titled JIS C 5432: "Electronic Equipment Round Type Connectors." JIS C 5432 is especially aiming at future standardization of new connectors. JR series connectors are designed to meet this specification. JR series connectors offer excellent performance

both electrically and mechanically. They have five keys in the fitting section to assure smooth coupling. A waterproof type is available. Contact arrangement performance of the pins is shown on page 160.

Material and Finish

Part name	Material	Finish
Shell	Aluminum alloy	Nickel plated
Insulator	Synthetic	
Pin contact	Copper alloy	Silver plated
Socket contact	Copper alloy	Silver plated

Ordering Information

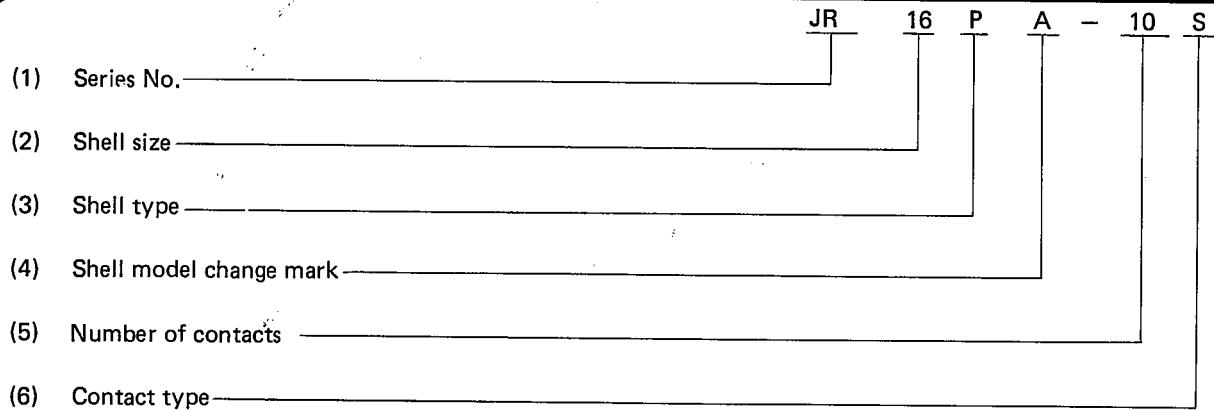

(1) Series No.: JR stands for JIS Round Connector

(2) Shell size: The shell size is 13, 16, 21, and 25

(3) Shell type:

- P: Plug
- J: Jack
- R: Receptacle
- RC: Receptacle Cap
- BP: Bayonet Lock Type Plug
- BR: Bayonet Lock Type Receptacle
- WP: Waterproof Type Plug
- WR: Waterproof Type Receptacle

(4) Shell model change mark:

Any change of shell configuration involves a new symbol mark A, B, D, E, and so on. C, J, P, and R, which are used for other connectors, are not used.

(5) Number of contacts

(6) Contact type:

- P: Pin contact
- PC: Crimp Pin Contact
- S: Socket contact
- SC: Crimp Socket Contact

Plug

(Soldering Type)

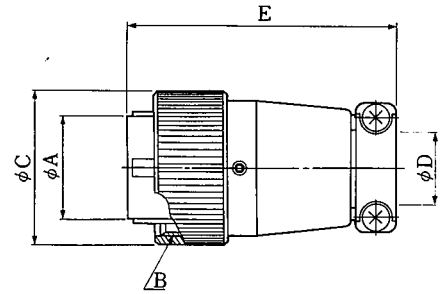
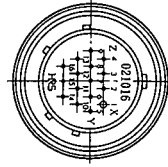
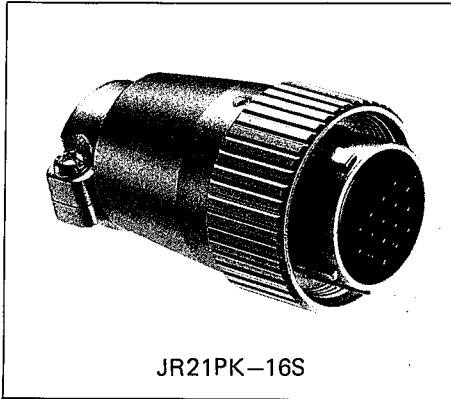

(An example in shape)

HRS No.	Part No.	No. of pins	ϕA	B	ϕC	ϕD	E	JIS No.
114-0501-7	JR13PK-3P	3	12.7	M18x1	21.8	8.5	45.5	CNRO1SPM013003
114-0502-0	JR13PK-5P	5	12.7	M18x1	21.8	8.5	45.5	CNRO1SPM013005
114-0503-2	JR16PK-7P	7	16.3	M22x1	25.8	11.5	49.5	CRNO1SPM016007
114-0504-5	JR16PK-10P	10	16.3	M22x1	25.8	11.5	49.5	CNRO1SPM016010
114-0505-8	JR21PK-10P	10	20.5	M26x1	29.8	15	53.5	CNRO1SPM021010
114-0506-0	JR21PK-16P	16	20.5	M26x1	29.8	15	53.5	CNRO1SPM021016
114-0507-3	JR25PK-16P	16	24.7	M30x1	33.8	18	56.5	CNRO1SPM025016
114-0508-6	JR25PK-24P	24	24.7	M30x1	33.8	18	56.5	CNRO1SPM025024
114-0552-8	JR25PK-4P	4	24.7	M30x1	33.8	18	56.5	—————
114-0554-3	JR25PK-5P	5	24.7	M30x1	33.8	18	56.5	—————
114-0556-9	JR25PK-8P	8	24.7	M30x1	33.8	18	56.5	—————

HRS No.	Part No.	No. of pins	ϕA	B	ϕC	ϕD	E	JIS No.
114-0509-9	JR13PK-3S	3	12.7	M18x1	21.8	8.5	45.5	CNRO1SPF013003
114-0510-8	JR13PK-5S	5	12.7	M18x1	21.8	8.5	45.5	CNRO1SPF013005
114-0511-0	JR16PK-7S	7	16.3	M22x1	25.8	11.5	49.5	CNRO1SPF016007
114-0512-3	JR16PK-10S	10	16.3	M22x1	25.8	11.5	49.5	CNRO1SPF016010
114-0513-6	JR21PK-10S	10	20.5	M26x1	29.8	15	53.5	CNRO1SPF021010
114-0514-9	JR21PK-16S	16	20.5	M26x1	29.8	15	53.5	CNRO1SPF021016
114-0515-1	JR25PK-16S	16	24.7	M30x1	33.8	18	56.5	CNRO1SPF025016
114-0516-4	JR25PK-24S	24	24.7	M30x1	33.8	18	56.5	CNRO1SPF025024
114-0553-0	JR25PK-4S	4	24.7	M30x1	33.8	18	56.5	—————
114-0555-6	JR25PK-5S	5	24.7	M30x1	33.8	18	56.5	—————
114-0557-1	JR25PK-8S	8	24.7	M30x1	33.8	18	56.5	—————

Note: Fasten a screw by means of torque wrench at 3.5~4.5kg·cm

Receptacle

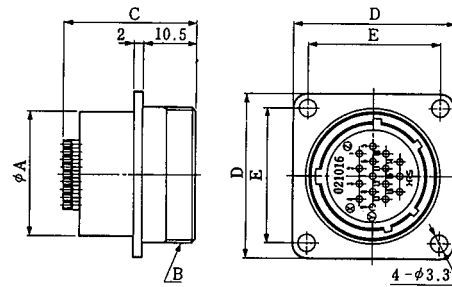
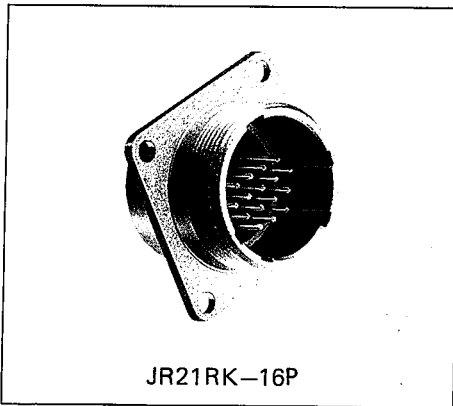

(An example in shape)

HRS No.	Part No.	No. of pins	ϕA	B	C	D	E	JIS No.
114-0517-7	JR13RK-3P	3	15.9	M18x1	26.6	26	20	CNR01SRM013003
114-0518-0	JR13RK-5P	5	15.9	M18x1	26.1	26	20	CNR01SRM013005
114-0519-2	JR16RK-7P	7	19.9	M22x1	26.6	29	23	CNR01SRM016007
114-0520-1	JR16RK-10P	10	19.9	M22x1	26.1	29	23	CNR01SRM016010
114-0521-4	JR21RK-10P	10	23.9	M26x1	26.6	32	26	CNR01SRM021010
114-0522-7	JR21RK-16P	16	23.9	M26x1	26.1	32	26	CNR01SRM021016
114-0523-0	JR25RK-16P	16	27.9	M30x1	26.6	35	29	CNR01SRM025016
114-0524-2	JR25RK-24P	24	27.9	M30x1	26.1	35	29	CNR01SRM025024
114-0558-4	JR25RK-4P	4	27.9	M30x1	28	35	29	—————
114-0560-6	JR25RK-5P	5	27.9	M30x1	26.6	35	29	—————
114-0562-1	JR25RK-8P	8	27.9	M30x1	26.6	35	29	—————

HRS No.	Part No.	No. of pins	ϕA	B	C	D	E	JIS No.
114-0525-5	JR13RK-3S	3	15.9	M18x1	28	26	20	CNR01SRF013003
114-0526-8	JR13RK-5S	5	15.9	M18x1	27	26	20	CNR01SRF013005
114-0527-0	JR16RK-7S	7	19.9	M22x1	28	29	23	CNR01SRF016007
114-0528-3	JR16RK-10S	10	19.9	M22x1	27	29	23	CNR01SRF016010
114-0529-6	JR21RK-10S	10	23.9	M26x1	28	32	26	CNR01SRF021010
114-0530-5	JR21RK-16S	16	23.9	M26x1	27	32	26	CNR01SRF021016
114-0531-8	JR25RK-16S	16	27.9	M30x1	28	35	29	CNR01SRF025016
114-0532-0	JR25RK-24S	24	27.9	M30x1	27	35	29	CNR01SRF025024
114-0559-7	JR25RK-4S	4	27.9	M30x1	28	35	29	—————
114-0561-9	JR25RK-5S	5	27.9	M30x1	27.8	35	29	—————
114-0563-4	JR25RK-8S	8	27.9	M30x1	27.8	35	29	—————

Jack

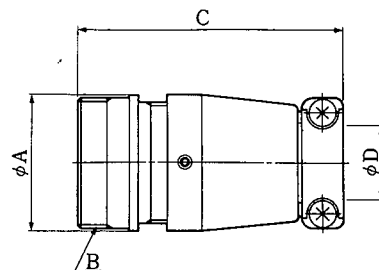
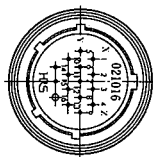
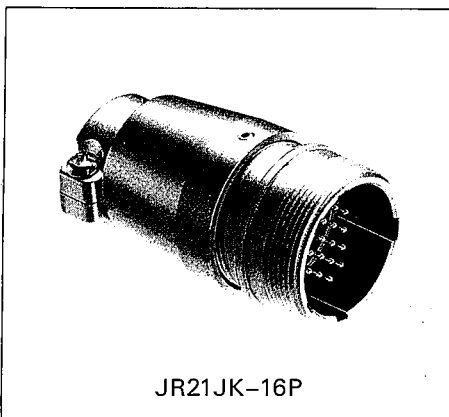

(An example in shape)

HRS No.	Part No.	No. of Pin	ϕA	B	C	ϕD
114-0533-3	JR13JK-3P	3	19	M18×1	44.5	8.5
114-0534-6	JR13JK-5P	5	19	M18×1	44.5	8.5
114-0535-9	JR16JK-7P	7	23	M22×1	48.5	11.5
114-0536-1	JR16JK-10P	10	23	M22×1	48.5	11.5
114-0537-4	JR21JK-10P	10	27	M26×1	52.5	15
114-0538-7	JR21JK-16P	16	27	M26×1	52.5	15
114-0564-7	JR25JK-4P	4	31	M30×1	55.5	18
114-0539-0	JR25JK-16P	16	31	M30×1	55.5	18
114-0540-9	JR25JK-24P	24	31	M30×1	55.5	18

HRS No.	Part No.	No. of Pin	ϕA	B	C	ϕD
114-0541-1	JR13JK-3S	3	19	M18×1	44.5	8.5
114-0542-4	JR13JK-5S	5	19	M18×1	44.5	8.5
114-0543-7	JR16JK-7S	7	23	M22×1	48.5	11.5
114-0544-0	JR16JK-10S	10	23	M22×1	48.5	11.5
114-0545-2	JR21JK-10S	10	27	M26×1	52.5	15
114-0546-5	JR21JK-16S	16	27	M26×1	52.5	15
114-0565-0	JR25JK-4S	4	31	M30×1	55.5	18
114-0548-0	JR25JK-24S	24	31	M30×1	55.5	18

Remark: Fasten a screw by means of torque wrench at 3.5~4.5kg-cm.

Plug (Crimp Type)

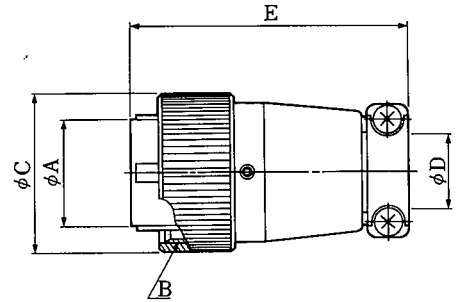
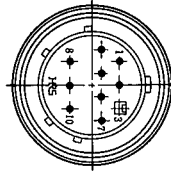
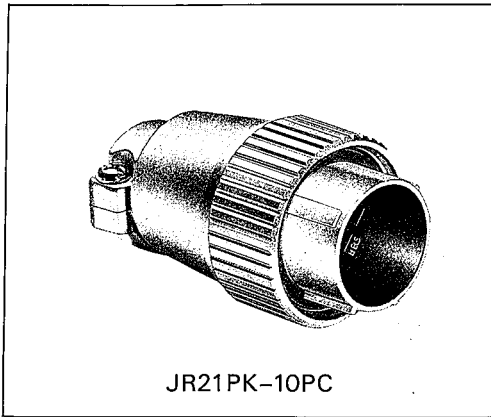

(An example in shape)

HRS No.	Part No.	No. of pins	ϕA	B	ϕC	ϕD	E	Remarks
114-0570-0	JR21PK-10PC	10	20.5	M26x1	29.8	15	53.5	Contact $\phi 1.6$
114-0571-2	JR21PK-10SC	10	20.5	M26x1	29.8	15	53.5	Contact $\phi 1.6$
114-0572-5	JR21PK-16PC	16	20.5	M26x1	29.8	15	53.5	Contact $\phi 1$
114-0573-8	JR21PK-16SC	16	20.5	M26x1	29.8	15	53.5	Contact $\phi 1$
114-0574-0	JR25PK-24PC	24	24.7	M30x1	33.8	18	56.5	Contact $\phi 1$
114-0575-3	JR25PK-24SC	24	24.7	M30x1	33.8	18	56.5	Contact $\phi 1$

Note: Fasten a screw by means of torque wrench at 3.5~4.5kg·cm

Receptacle

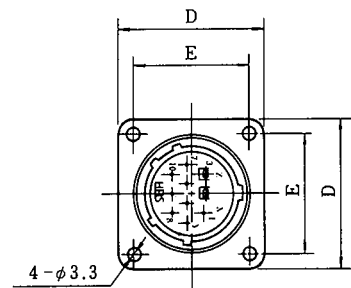
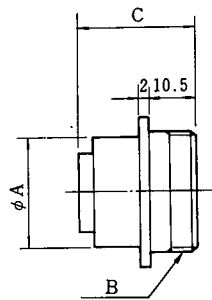
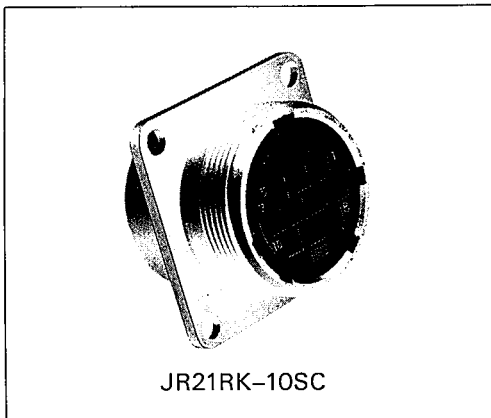

(An example in shape)

HRS No.	Part No.	No. of pins	ϕA	B	ϕC	ϕD	E	Remarks
114-0576-6	JR21RK-10PC	10	23.9	M26x1	27.6	32	26	Contact $\phi 1.6$
114-0577-9	JR21RK-10SC	10	23.9	M26x1	27.6	32	26	Contact $\phi 1.6$
114-0578-1	JR21RK-16PC	16	23.9	M26x1	25.4	32	26	Contact $\phi 1$
114-0579-4	JR21RK-16SC	16	23.9	M26x1	23	32	26	Contact $\phi 1$
114-0580-3	JR25RK-24PC	24	27.9	M30x1	25.4	35	29	Contact $\phi 1$
114-0581-6	JR25RK-24SC	24	27.9	M30x1	23	35	29	Contact $\phi 1$

Cap for Receptacle

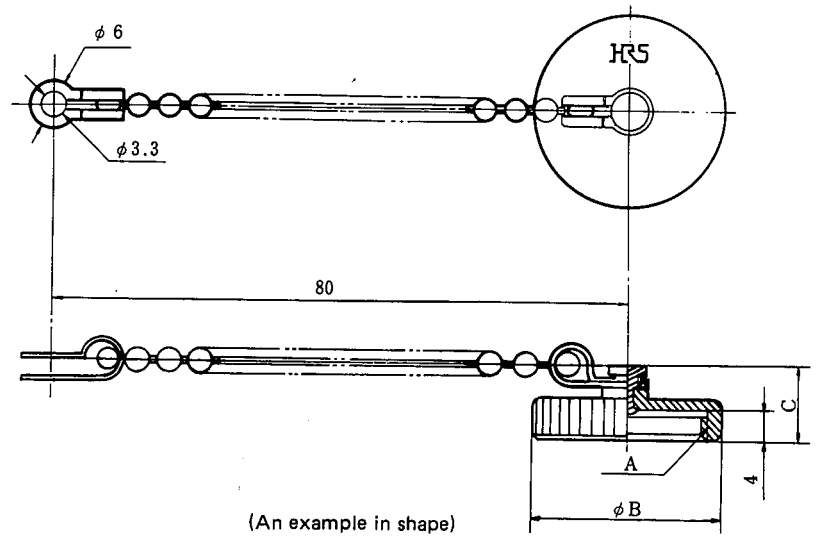
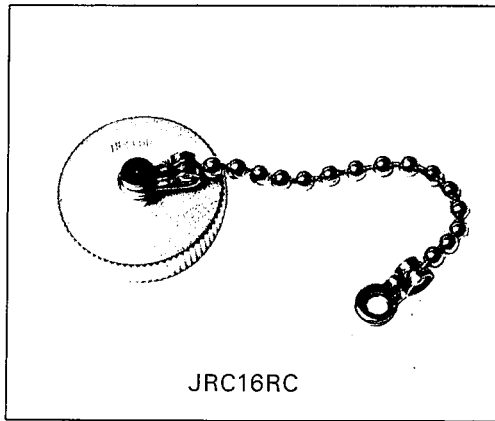

HRS No.	Part No.	A	ϕB	C	JIS No.
114-0053-8	JRC13RC	M18x1	21	10	CNR01RC013
114-0054-0	JRC16RC	M22x1	25	10	CNR01RC016
114-0055-3	JRC21RC	M26x1	29	10	CNR01RC021
114-0056-6	JRC25RC	M30x1	33	10	CNR01RC025

Contact

Contact diameter $\phi 1.0$ mm

Male Pin

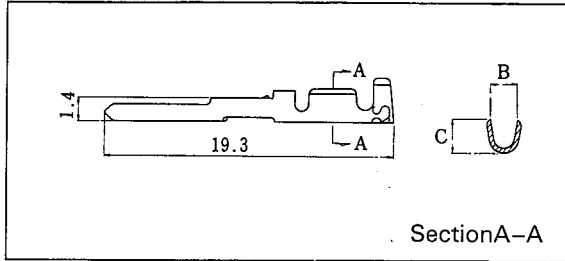

Type	HRS No.	Part No.	B	C	Applicable wire
Bulk	114-0243-3	JRC-PC2-112	1.6	2.0	AWG#20~#24
	114-0244-6	JRC-PC2-122	1.45	1.5	AWG#24~#28
Chain	114-0245-9	JRC-PC2-212	1.6	2.0	AWG#20~#24
	114-0246-1	JRC-PC2-222	1.45	1.5	AWG#24~#28

Female Pin

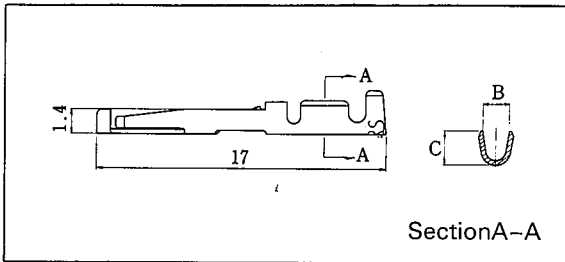

Type	HRS No.	Part No.	B	C	Applicable wire
Bulk	114-0247-4	JRC-SC2-112	1.6	2.0	AWG#20~#24
	114-0248-7	JRC-SC2-122	1.45	1.5	AWG#24~#28
Chain	114-0249-0	JRC-SC2-212	1.6	2.0	AWG#20~#24
	114-0250-9	JRC-SC2-222	1.45	1.5	AWG#24~#28

Note: Bulk in bags of 100 pcs. chain or reels of 8,000 pcs.

Contact diameter $\phi 1.6$ mm

Male Pin

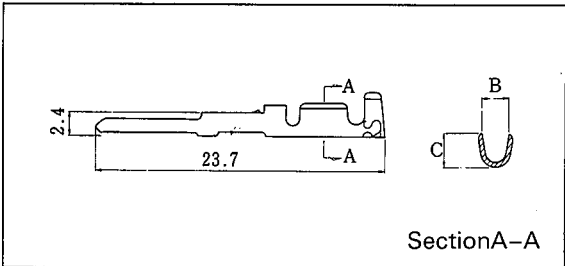

Type	HRS No.	Part No.	B	C	Applicable wire
Bulk	114-0239-6	JRC-PC-112	2.3	2.9	AWG#16~#20
Chain	114-0240-5	JRC-PC-212	2.3	2.9	AWG#16~#20

Female Pin

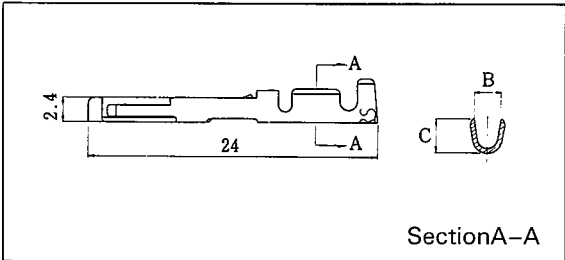

Type	HRS No.	Part No.	B	C	Applicable wire
Bulk	114-0241-8	JRC-SC-112	2.3	2.9	AWG#16~#20
Chain	114-0242-0	JRC-SC-212	2.3	2.9	AWG#16~#20

Note: Bulk in bags of 100 pcs. chain or reels of 8,000 pcs.

Tools

Contact diameter	Type	Item	HRS No.	Part No.	Applicable terminal	Applicable wire
φ 1	Manual	Manual crimping tool	150-0006-1	RM-TC-11	JRC-PC2-112 JRC-SC2-112	AWG # 20~ # 24
			150-0007-4	RM-TC-12	JRC-PC2-122 JRC-SC2-122	AWG # 24~ # 28
	Automatic	Automatic crimping machine body	901-0005-4	CM-105	—	—
			—	AP105-JRC-1	JRC-PC2-212 JRC-SC2-212	AWG # 20~ # 24
	—	AP105-JRC-2	JRC-PC2-222 JRC-SC2-222	AWG # 24~ # 28		
Extractor	150-0008-7	RM-TP	—	—		
φ 1.6	Manual	Manual crimping tool	150-0033-4	JRC-TC-11	JRC-PC-112 JRC-SC-112	AWG # 16
			150-0034-7	JRC-TC-12	JRC-PC-112 JRC-SC-112	AWG # 18~ # 20
	Automatic	Automatic crimping machine body	901-0005-4	CM-105	—	—
			—	AP105-JRC-1	JRC-PC-212	AWG # 16~ # 20
	Extractor	150-0035-0	JRC-TP	—	—	
Hexagon bar wrench (opposing side-to-side distance 1.27)			150-0066-3	PB205/1.27	—	—

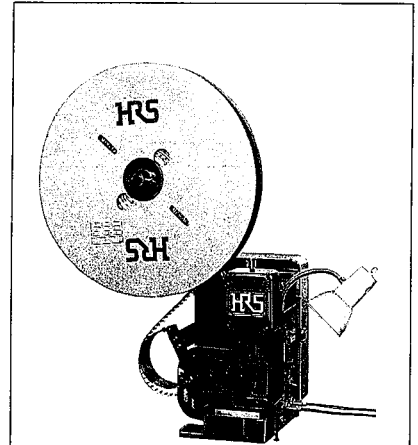

Automatic crimping Machine CM-105

Hand Tool Crimp

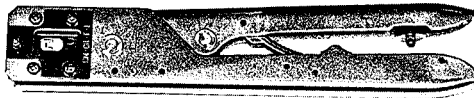

For Contact Diameter φ 1.0 mm



For Contact Diameter φ 1.6 mm

Extraction Tool



For Contact Diameter φ 1.0 mm



For Contact Diameter φ 1.6 mm

Hexagon Wrench Driver (1.27)

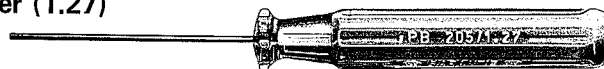

(PB 205/1.27)

HRS No.	Part No.
150-0066-3	PB205-1.27

Bayonet Lock Type Plug (Solder Type)

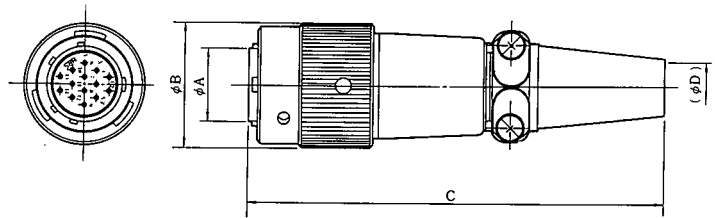
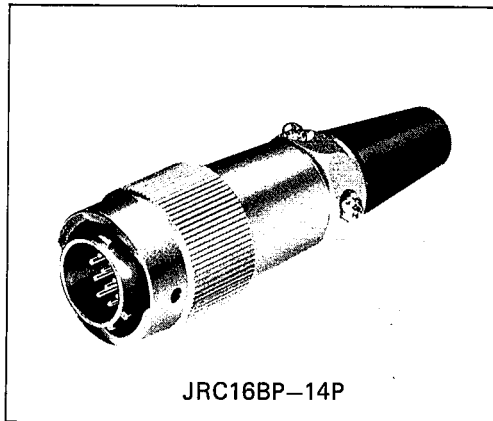

(An example in shape)

HRS No.	Part No.	No. of pins	Aφ	Bφ	C	Dφ
114-0253-7	JRC16BP-7P	7	16.3	27	91	11.2
114-0252-4	JRC16BP-10P	10	16.3	27	91	11.2
114-0251-1	JRC16BP-14P	14	16.3	27	91	11.2
114-0268-4	JRC21BPA-26P	26	20.5	31	98	12.2

HRS No.	Part No.	No. of pins	Aφ	Bφ	C	Dφ
114-0256-5	JRC16BP-7S	7	16.3	27	91	11.2
114-0255-2	JRC16BP-10S	10	16.3	27	91	11.2
114-0254-0	JRC16BP-14S	14	16.3	27	91	11.2
114-0267-1	JRC21BP-26S	26	20.3	31	98	12.2

Remark: Fasten a screw by means of torque wrench at 3.5~4.5 kg-cm.

Bayonet Lock Type Receptacle

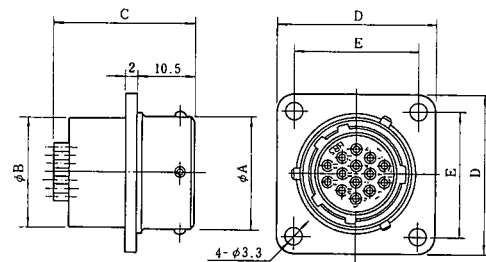
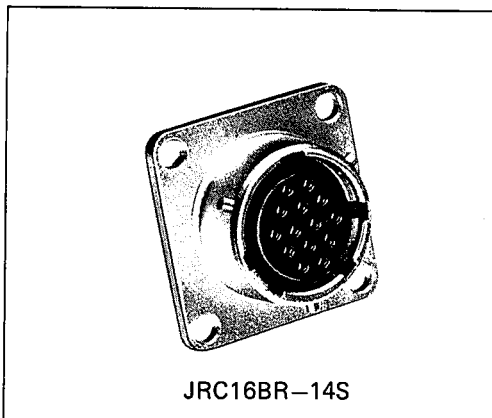

(An example in shape)

HRS No.	Part No.	No. of pins	Aφ	Bφ	C	D	E
114-0259-3	JRC16BR-7P	7	20.5	19.9	26.5	29	23
114-0258-0	JRC16BR-10P	10	20.5	19.9	26.5	29	23
114-0257-8	JRC16BR-14P	14	20.5	19.9	26.6	29	23
114-0269-7	JRC21BR-26P	26	25.8	23.9	26.8	32	26

HRS No.	Part No.	No. of pins	Aφ	Bφ	C	D	E
114-0262-8	JRC16BR-7S	7	20.5	19.9	27.7	29	23
114-0261-5	JRC16BR-10S	10	20.5	19.9	26.5	29	23
114-0260-2	JRC16BR-14S	14	20.5	19.9	25.8	29	23
114-0270-6	JRC21BRA-26S	26	25.8	23.9	28	32	26

Waterproof Type Plug (Soldering Type)

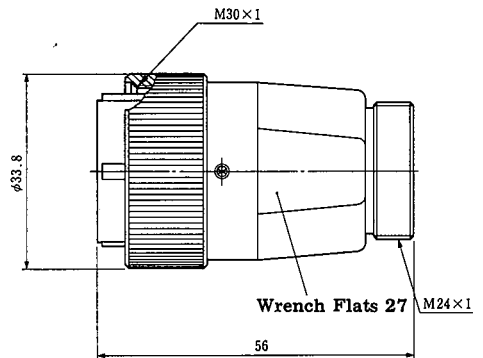
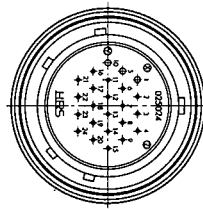
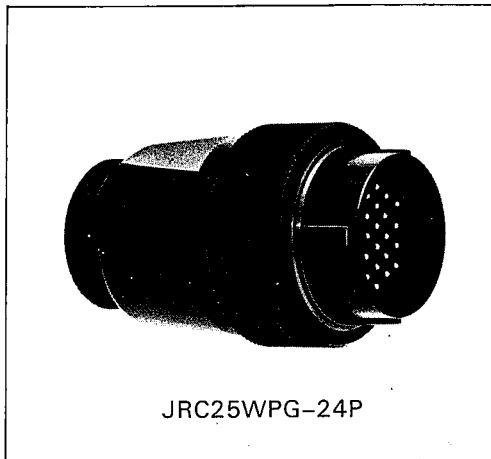

(An example in shape)

HRS No.	Part No.	No. of pins	HRS No.	Part No.	No. of pins
114-1007-6	JRC25WPG-4P	4	114-1018-2	JRC25WPG-4S	4
114-1008-9	JRC25WPG-5P	5	114-1020-4	JRC25WPG-8S	8
114-1009-1	JRC25WPG-8P	8	114-1021-7	JRC25WPG-16S	16
114-1010-0	JRC25WPG-16P	16	114-1022-0	JRC25WPG-24S	24
114-1011-3	JRC25WPG-24P	24			

Remark: Fasten a screw by means of torque wrench at 3.5 ~ 4.5 kg-cm.

Receptacle (Waterproof type)

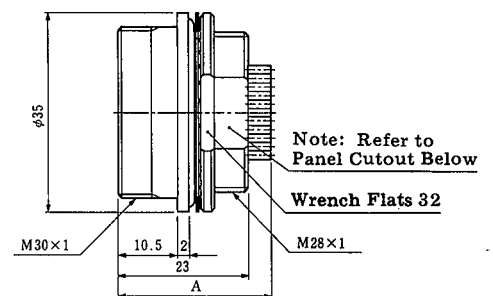
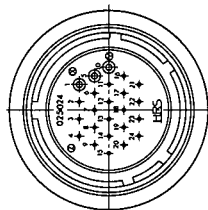
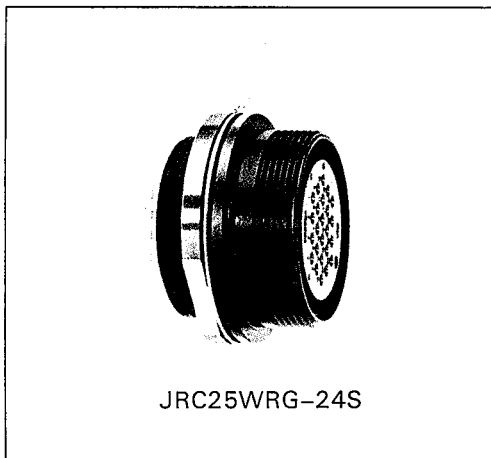

(An example in shape)

HRS No.	Part No.	No. of pins	A	HRS No.	Part No.	No. of pins	A
114-1029-9	JRC25WRG-4P	4	28	114-1040-1	JRC25WRG-4S	4	27.9
114-1031-0	JRC25WRG-8P	8	26.8	114-1041-4	JRC25WRG-5S	5	27.8
114-1032-3	JRC25WRG-16P	16	26.8	114-1042-7	JRC25WRG-8S	8	27.8
114-1033-6	JRC25WRG-24P	24	26.8	114-1043-0	JRC25WRG-16S	16	27.8
				114-1044-2	JRC25WRG-24S	24	26.5

Remark: Applicable panel thickness: Max. 6.5 mm.

Cable Clamp (Waterproof type)

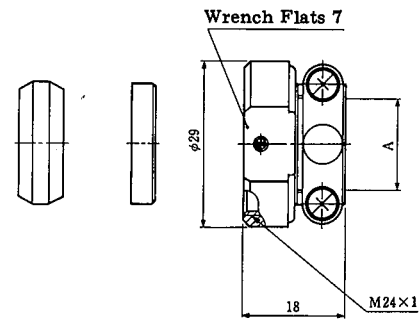

Remark: The clamp locking screw should be tightened with a torque of 0.3 to 0.4 N-m (3.5 to 4.5 kg-cm).

HRS No.	Part No.	A	HRS No.	Part No.	A
114-1046-8	JRC25WPG-CP8	8	114-1048-3	JRC25WPG-CP12	12
114-1047-0	JRC25WPG-CP10	10	114-1049-6	JRC25WPG-CP14	14
			114-1050-5	JRC25WPG-CP16	16

- Note 1) JR Waterproof type is modified from current JR series. Electrical specifications are same as current JR series.
- 2) Sealing capability: Submersible at 1.8 m depth for 48 hours. Watertight coupling (Cable clamp) between the plug and the cable is dependent upon how the outer jacket of the cables fits in the sealing bushing. It is required, therefore, to select the most suitable cable clamp that meets the cable diameter when ordering connectors. Refer to A above for cable diameter.

JR Series Contact Arrangement

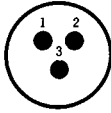
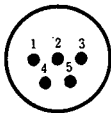
Shell size		
13		
No. of pins	3	5
Withstanding voltage	AC1000V a minute	AC1000V a minute
Current rating	10A	5A
Insulation resistance	1000MΩ MIN.	1000MΩ MIN.
Contact resistance	5mΩ MAX.	5mΩ MAX.
Solder cup dia.	1.7φ	1.1φ

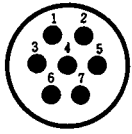
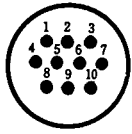
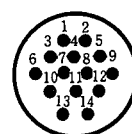
Shell size			
16			
No. of pins	7	10	14
Withstanding voltage	AC1000V a minute	AC1000V a minute	AC1000V a minute
Current rating	10A	5A	5A
Insulation resistance	1000MΩ MIN.	1000MΩ MIN.	1000MΩ MIN.
Contact resistance	5mΩ MAX.	5mΩ MAX.	5mΩ MAX.
Solder cup dia.	1.7φ	1.1φ	1.1φ

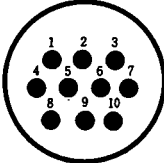
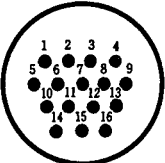
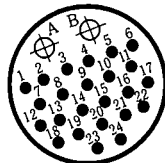
Shell size				
21				
No. of pins	10	16	26	
Withstanding voltage	AC1000V a minute	AC1000V a minute	AC 1000V a minute	
Current rating	10A	5A (CRIMP 3A)	5A	10A (only A, B)
Insulation resistance	1000MΩ MIN.	1000MΩ MIN.	1000MΩ MIN.	
Contact resistance	5mΩ MAX.	5mΩ MAX. (CRIMP 10mΩ)	5mΩ MAX.	
Solder cup dia.	1.7φ	1.1φ	1.1φ	1.7φ (only A, B)

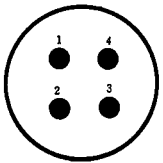
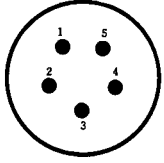
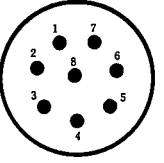
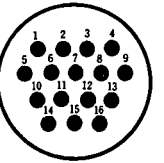
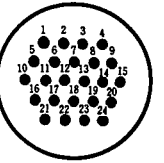
Shell size					
25					
No. of pins	4	5	8	16	24
Withstanding voltage	AC3000V a minute	AC3000V a minute	AC3000V a minute	AC1000V a minute	AC1000V a minute
Current rating	30A	10A	10A	10A	5A (CRIMP 3A)
Insulation resistance	10,000MΩ MIN.	10,000MΩ MIN.	10,000MΩ MIN.	1000MΩ MIN.	1000MΩ MIN.
Contact resistance	5mΩ MAX.	5mΩ MAX.	5mΩ MAX.	5mΩ MAX.	5mΩ MAX. (CRIMP 10mΩ)
Solder cup dia.	3.4φ	1.7φ	1.7φ	1.7φ	1.1φ

Remarks: 1. View direction: Mating surface of pin insert.
2. The withstand voltage is the test value.

Copyright © Each Manufacturing Company.

All Datasheets cannot be modified without permission.

This datasheet has been download from :

www.AllDataSheet.com

100% Free DataSheet Search Site.

Free Download.

No Register.

Fast Search System.

www.AllDataSheet.com