

Varistor Products

High Energy, High Multiple Pulse Capability Radial Lead

RoHS C-III Varistor Series



The C-III Series of metal-oxide varistors are specifically designed for applications requiring high surge energy absorption ratings and superior multiple pulse absorption rating. This is achieved through a special dielectric material formulation which also results in higher repetitive surge ratings than other MOV types.

The C-III series is primarily intended for use in AC line Transient Voltage Surge Suppressor (TVSS) product environment and other similar applications requiring high transient energy and peak current capability in a relatively small package size.

The C-III series is supplied in 10mm, 14mm and 20mm disc versions with various lead options.

These types are shipped in bulk or Tape and Reel packaging. Part number and brand information is provided in the Ratings table.

Features

- Lead-free and RoHS compliant option available. Please see the device and ratings specifications table for more information.
- High Energy Absorption Capability
 W_{TM} 40J to 530J (2ms)
- High Pulse Life Rating
- High Peak Pulse Current Capability
 I_{TM} 3500A to 9000A (8/20 μ s)
- Wide Operating Voltage Range
 $V_{M(AC)RMS}$ 130V to 680V
- Available in Tape and Reel for Automatic Insertion; Also Available with Crimped and/or Trimmed Lead Styles
- No Derating Up to 85°C Ambient

AGENCY APPROVALS: Recognized under the components program of Underwriters Laboratories. Certified by CSA, VDE and CECC.

AGENCY FILE NUMBERS: UL E75961, CSA LR91788, VDE 116895E, CECC 42201-006.

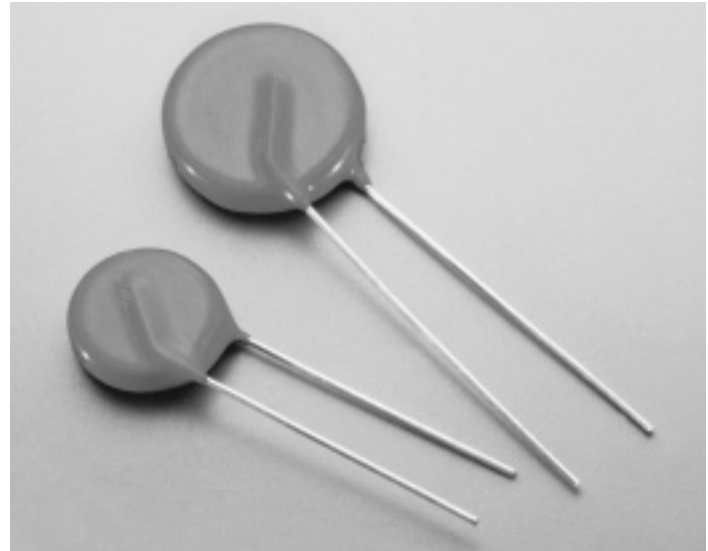

**NEW LEAD-FREE AND
RoHS COMPLIANT PARTS
AVAILABLE**

**ALSO SEE LITTELFUSE
ULTRAMOV™ VARISTOR SERIES**

Varistor Products

High Energy Radial Lead

RoHS C-III Varistor Series

Absolute Maximum Ratings For ratings of individual members of a series, see Device Ratings and Specifications chart

	C-III SERIES	UNITS
Continuous:		
Steady State AC Voltage Range ($V_{M(AC)RMS}$)	130 to 660	V
Transients:		
Single-Pulse Peak Current (I_{TM}) 8/20 μ s Wave (See Figure 2)	3500 to 9000	A
Single-Pulse Energy Range (W_{TM}) 2ms Rectangular Wave	40 to 530	J
Maximum Temporary Overvoltage of $V_{M(AC)}$:		
5 Minutes Duration @ 25°C	130	%
5 Minutes Duration @ 125°C	120	%
Operating Ambient Temperature Range (T_A)	-55 to 85	°C
Storage Temperature Range (T_{STG})	-55 to 125	°C
Temperature Coefficient ($\square V$) of Clamping Voltage (V_C) at Specified Test Current	<0.0	%/°C

CAUTION: Stresses above those listed in "Absolute Maximum Ratings" may cause permanent damage to the device. This is a stress only rating and operation of the device at these or any other conditions above those indicated in the operational sections of this specification is not implied.

C-III Series Ratings

 LEAD-FREE AND RoHS COMPLIANT MODELS		STANDARD MODELS		MAXIMUM RATINGS (85°C)			
				CONTINUOUS		TRANSIENT	
				MAXIMUM V_{RMS} $V_{M(AC)}$ (V)	WITHSTANDING ENERGY (2ms) W_{TM} (J)	PEAK CURRENT (8/20 μ s)	
I_{TM1} 1 PULSE (A)	I_{TM2} 2 PULSES (A)						
PART NUMBER	BRANDING	PART NUMBER	BRANDING				
V130LA5CP	P130L5C	V130LA5C	130L5C	130	40	3500	3000
V130LA10CP	P130L10C	V130LA10C	130L10C	130	80	6000	5000
V130LA20CP	P130L20C	V130LA20C	130L20C	130	200	9000	7000
V130LA20CPX325	P130X325	V130LA20CX325	130CX325	130	200	9000	7000
V140LA5CP	P140L5C	V140LA5C	140L5C	140	45	3500	3000
V140LA10CP	P140L10C	V140LA10C	140L10C	140	90	6000	5000
V140LA20CP	P140L20C	V140LA20C	140L20C	140	210	9000	7000
V140LA20CPX340	P140X340	V140LA20CX340	140CX340	140	210	9000	7000
V150LA5CP	P150L5C	V150LA5C	150L5C	150	50	3500	3000
V150LA10CP	P150L10C	V150LA10C	150L10C	150	100	6000	5000
V150LA20CP	P150L20C	V150LA20C	150L20C	150	215	9000	7000
V150LA20CPX360	P150X360	V150LA20CX360	150CX360	150	215	9000	7000
V175LA5CP	P175L5C	V175LA5C	175L5C	175	55	3500	3000
V175LA10CP	P175L10C	V175LA10C	175L10C	175	110	6000	5000
V175LA20CP	P175L20C	V175LA20C	175L20C	175	220	9000	7000
V175LA20CPX425	P175X425	V175LA20CX425	175CX425	175	220	9000	7000
V230LA10CP	P230L10C	V230LA10C	230L10C	230	60	3500	3000
V230LA20CP	P230L20C	V230LA20C	230L20C	230	125	6000	5000
V230LA40CP	P230L40C	V230LA40C	230L40C	230	280	9000	7000
V230LA40CPX570	P230X570	V230LA40CX570	230X570	230	280	9000	7000
V250LA10CP	P250L10C	V250LA10C	250L10C	250	65	3500	3000
V250LA20CP	P250L20C	V250LA20C	250L20C	250	135	6000	5000
V250LA40CP	P250L40C	V250LA40C	250L40C	250	300	9000	7000
V250LA40CPX620	P250X620	V250LA40CX620	250CX620	250	300	9000	7000
V275LA10CP	P275L10C	V275LA10C	275L10C	275	70	3500	3000
V275LA20CP	P275L20C	V275LA20C	275L20C	275	145	6000	5000
V275LA40CP	P275L40C	V275LA40C	275L40C	275	320	9000	7000
V275LA40CPX680	P275X680	V275LA40CX680	275CX680	275	320	9000	7000
V300LA10CP	P300L10C	V300LA10C	300L10C	300	75	3500	3000
V300LA20CP	P300L20C	V300LA20C	300L20C	300	155	6000	5000
V300LA40CP	P300L40C	V300LA40C	300L40C	300	335	9000	7000
V300LA40CPX745	P300X745	V300LA40CX745	300CX745	300	335	9000	7000
V320LA10CP	P320L10C	V320LA10C	320L10C	320	80	3500	3000
V320LA20CP	P320L20C	V320LA20C	320L20C	320	165	6000	5000
V320LA40CP	P320L40C	V320LA40C	320L40C	320	345	9000	7000
V320LA40CPX810	P320X810	V320LA40CX810	320CX810	320	345	9000	7000
V385LA20CP	P385L20C	V385LA20C	385L20C	385	175	6000	5000
V385LA40CP	P385L40C	V385LA40C	385L40C	385	370	9000	7000
V420LA20CP	P420L20C	V420LA20C	420L20C	420	185	6000	5000
V420LA40CP	P420L40C	V420LA40C	420L40C	420	390	9000	7000
V460LA40CP	P460L40C	V460LA40C	460L40C	460	430	9000	7000
V480LA80CP	P480L80C	V480LA80C	480L80C	480	420	9000	7000
V510LA80CP	P510L80C	V510LA80C	510L80C	510	440	9000	7000
V550LA80CP	P550L80C	V550LA80C	550L80C	550	450	9000	7000
V575LA80CP	P575L80C	V575LA80C	575L80C	575	460	9000	7000
V625LA80CP	P625L80C	V625LA80C	625L80C	625	490	9000	7000
V660LA80CP	P660L80C	V660LA80C	660L80C	660	510	9000	7000
V680LA100CP	P680L100C	V680LA100C	680L100C	680	520	9000	7000

2



VARISTOR PRODUCTS

Varistor Products

High Energy Radial Lead

RoHS C-III Varistor Series

C-III Series Specifications

  LEAD-FREE AND RoHS COMPLIANT MODELS PART NUMBER	STANDARD MODELS PART NUMBER	MODEL SIZE DISC DIAMETER (mm)	SPECIFICATIONS (25°C)						
			VARISTOR VOLTAGE AT 1mA DC TEST CURRENT		MAXIMUM CLAMPING VOLTAGE (8/20µs)		DUTY CYCLE SURGE RATING		
			V_N MIN (V)	V_N MAX (V)	V_C (V)	I_p (A)	3kA (8/20µs) # PULSES	750A (8/20µs) # PULSES	
V130LA5CP	V130LA5C	10	184	228	340	25	2	100	
V130LA10CP	V130LA10C	14	184	228	340	50	40	600	
V130LA20CP	V130LA20C	20	184	228	340	100	80	1600	
V130LA20CPX325	V130LA20CX325	20	184	220	325	100	80	1600	
V140LA5CP	V140LA5C	10	198	242	360	25	2	100	
V140LA10CP	V140LA10C	14	198	242	360	50	40	600	
V140LA20CP	V140LA20C	20	198	242	360	100	80	1600	
V140LA20CPX340	V140LA20CX340	20	198	230	340	100	80	1600	
V150LA5CP	V150LA5C	10	212	268	395	25	2	100	
V150LA10CP	V150LA10C	14	212	268	395	50	40	600	
V150LA20CP	V150LA20C	20	212	268	395	100	80	1600	
V150LA20CPX360	V150LA20CX360	20	212	243	360	100	80	1600	
V175LA5CP	V175LA5C	10	247	303	455	25	2	100	
V175LA10CP	V175LA10C	14	247	303	455	50	40	600	
V175LA20CP	V175LA20C	20	247	303	455	100	80	1600	
V175LA20CPX425	V175LA20CX425	20	247	285	425	100	80	1600	
V230LA10CP	V230LA10C	10	324	396	595	25	2	100	
V230LA20CP	V230LA20C	14	324	396	595	50	40	600	
V230LA40CP	V230LA40C	20	324	396	595	100	80	1600	
V230LA40CPX570	V230LA40CX570	20	324	384	570	100	80	1600	
V250LA10CP	V250LA10C	10	354	429	650	25	2	100	
V250LA20CP	V250LA20C	14	354	429	650	50	40	600	
V250LA40CP	V250LA40C	20	354	429	650	100	80	600	
V250LA40CPX620	V250LA40CX620	20	354	413	620	100	80	1600	
V275LA10CP	V275LA10C	10	389	473	710	25	2	100	
V275LA20CP	V275LA20C	14	389	473	710	50	40	600	
V275LA40CP	V275LA40C	20	389	473	710	100	80	1600	
V275LA40CPX680	V275LA40CX680	20	389	453	680	100	80	1600	
V300LA10CP	V300LA10C	10	420	517	775	25	2	100	
V300LA20CP	V300LA20C	14	420	517	775	50	40	600	
V300LA40CP	V300LA40C	20	420	517	775	100	80	1600	
V300LA40CPX745	V300LA40CX745	20	420	490	745	100	80	1600	
V320LA10CP	V320LA10C	10	462	565	850	25	2	100	
V320LA20CP	V320LA20C	14	462	565	850	50	40	600	
V320LA40CP	V320LA40C	20	462	565	850	100	80	1600	
V320LA40CPX810	V320LA40CX810	20	462	540	810	100	80	1600	
V385LA20CP	V385LA20C	14	558	682	1025	50	40	600	
V385LA40CP	V385LA40C	20	558	682	1025	100	80	1600	
V420LA20CP	V420LA20C	14	610	748	1120	50	40	600	
V420LA40CP	V420LA40C	20	610	748	1120	100	80	1600	
V460LA40CP	V460LA40C	20	640	790	1190	100	80	1600	
V480LA80CP	V480LA80C	20	670	825	1240	100	80	1600	
V510LA80CP	V510LA80C	20	735	910	1350	100	80	1600	
V550LA80CP	V550LA80C	20	780	970	1435	100	80	1600	
V575LA80CP	V575LA80C	20	805	1000	1500	100	80	1600	
V625LA80CP	V625LA80C	20	900	1100	1725	100	80	1600	
V660LA80CP	V660LA80C	20	940	1210	1820	100	80	1600	
V680LA100CP	V680LA100C	20	990	1130	1700	100	80	1600	

NOTE: • Average power dissipation of transients not to exceed 0.6W and 1W for model sizes 14mm and 20mm, respectively.
 • 7mm and 12mm parts also available-contact factory for further information
 • For additional or intermediary voltage ratings contact factory

Varistor Products

High Energy Radial Lead

RoHS C-III Varistor Series

Power Dissipation Ratings

Should transients occur in rapid succession, the average power dissipation is the energy (watt-seconds) per pulse times the number of pulses per second. The power so developed must be within the specifications shown on the Device Ratings and Specifications table for the specific device. The operating values of a MOV need to be derated at high temperatures as shown in Figure 1. Because varistors only dissipate a relatively small amount of average power they are not suitable for repetitive applications that involve substantial amounts of average power dissipation.

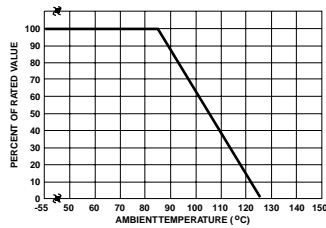

FIGURE 1. CURRENT, ENERGY AND POWER DERATING CURVE

Should transients occur in rapid succession, the average power dissipation is the energy (watt-seconds) per pulse times the number of pulses per second. The power so developed must be within the specifications shown on the Device Ratings and Specifications table for the specific device. The operating values of a MOV need to be derated at high temperatures as shown in Figure 1. Because varistors only dissipate a relatively small amount of average power they are not suitable for repetitive applications that involve substantial amounts of average power dissipation.

Transient V-I Characteristics Curves

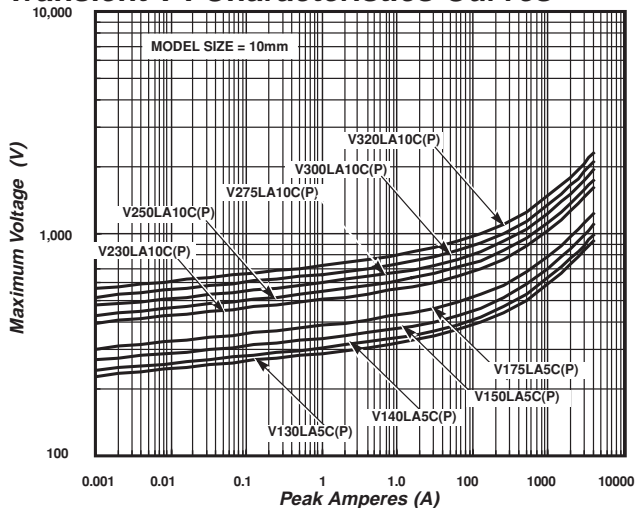

Figure 3. Maximum Clamping Voltage for 10mm Parts (V130LA5C(P) -V320LA10C(P))

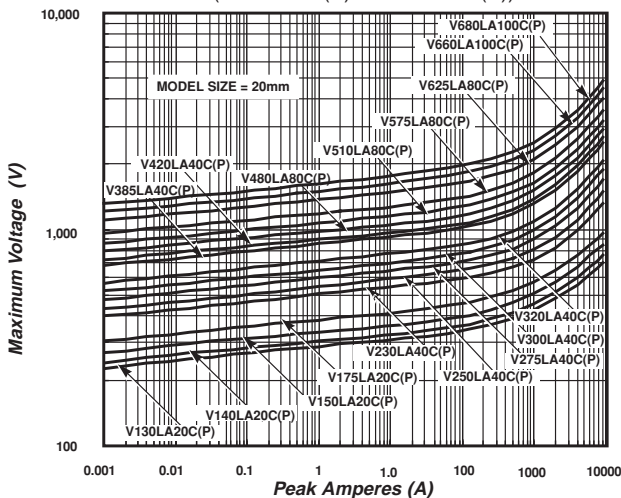
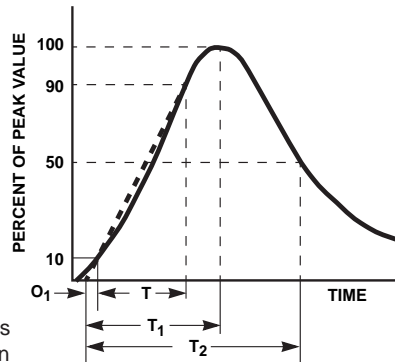

Figure 5. Maximum Clamping Voltage for 20mm Parts (V130LA20C(P) -V680LA100C(P))



O_1 = Virtual Origin of Wave
 T = Time From 10% to 90% of Peak
 T_1 = Virtual Front time = $1.25 \cdot t$
 T_2 = Virtual Time to Half Value (Impulse Duration)
 Example: For an 8/20 μ s Current Waveform:
 8μ s = T_1 = Virtual Front Time
 20μ s = T_2 = Virtual Time to Half Value

FIGURE 2. PEAK PULSE CURRENT TEST WAVEFORM

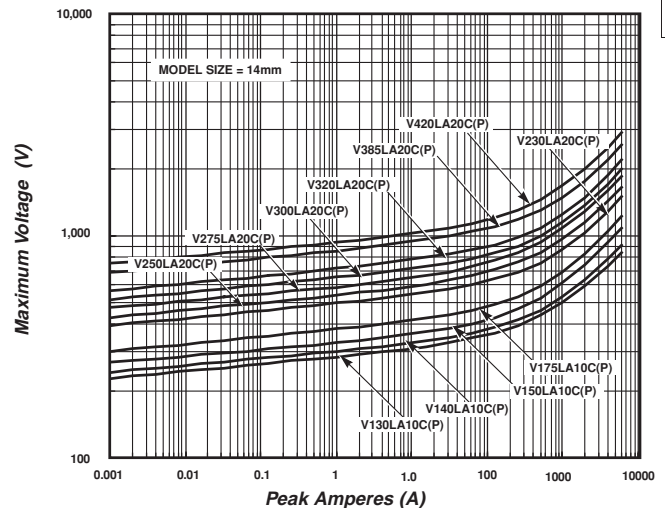

Figure 4. Maximum Clamping Voltage for 14mm Parts (V130LA10C(P) -V420LA20C(P))

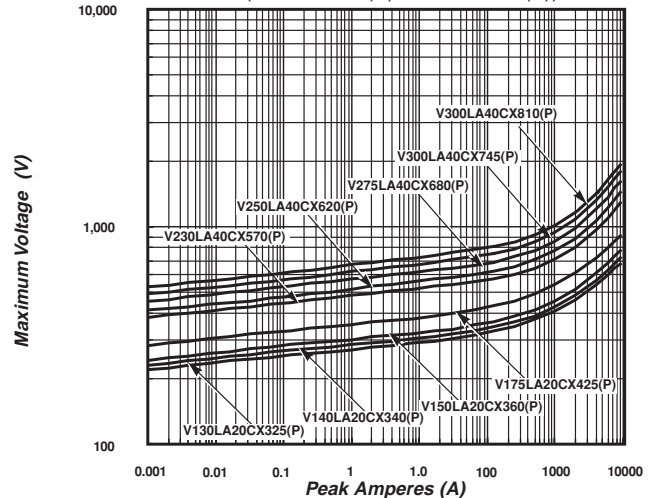

Figure 6. Maximum Clamping Voltage for Low Clamping Voltage Parts (V130LA20CX325(P) -V300LA40CX245(P))

2
VARISTOR PRODUCTS

Varistor Products

High Energy Radial Lead

RoHS **Pb** **C-III Varistor Series**

Pulse Rating Curves

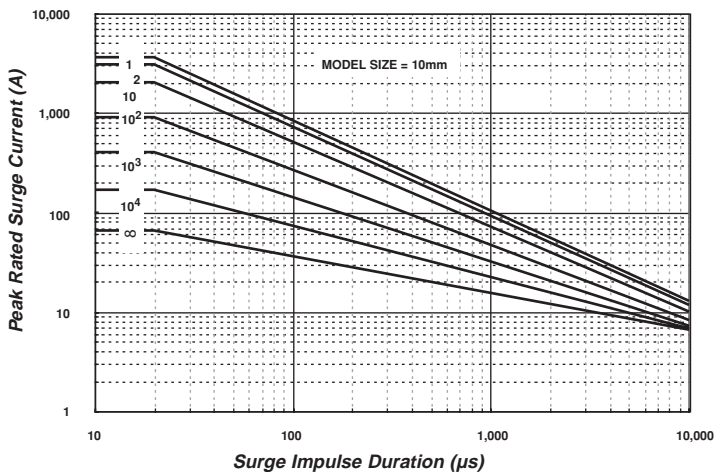

Figure 7. Repetitive Surge Capability for 10mm Parts
(V130LA5C(P)-V320LA10C(P))

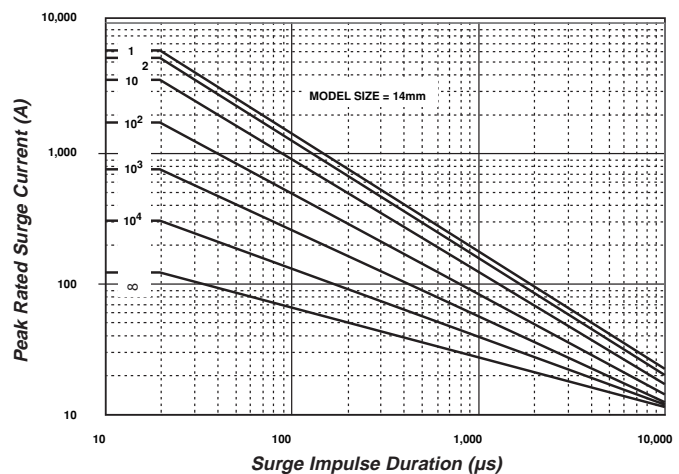

Figure 8. Repetitive Surge Capability for 14mm Parts
(V130LA10C(P)-V420LA20C(P))

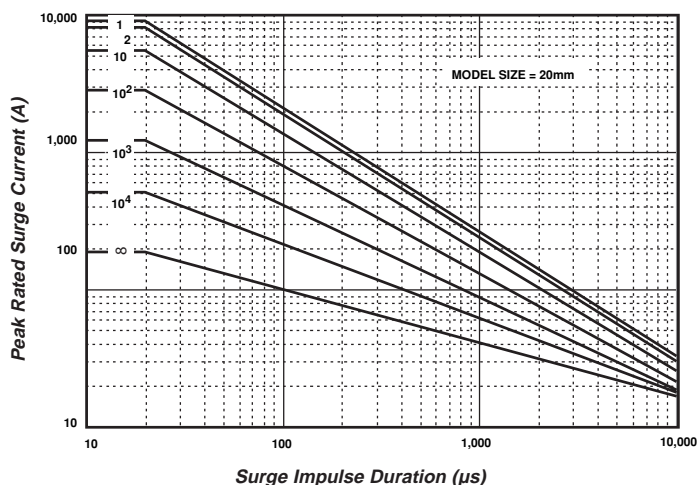

Figure 9. Repetitive Surge Capability for 20mm Parts
(V130LA20C(P)-V680LA100C(P))

CIII series varistors for Hi-Temperature operating conditions:

- Phenolic Coated CIII Series devices are available with improved maximum operating maximum temperature 125°C.
- These devices also have improved temperature cycling performance capability.
- Ratings and Specifications are as per standard CIII Series except Hi-Pot encapsulation Isolation Voltage Capability = 500V.
- To order: add X1347 to part number (e.g. V230LA40CX1347)
- These devices are not UL, CSA, VDE or CECC certified.
- Contact factory for further details.

Varistor Products

High Energy Radial Lead

RoHS C-III Varistor Series

Tape and Reel Specification (available for voltage ratings up to 320V only)

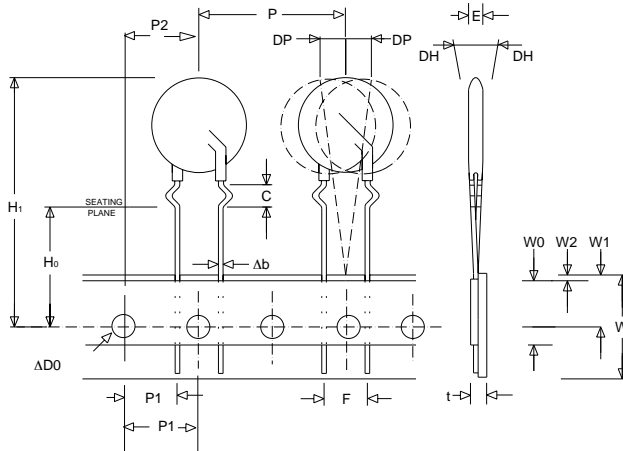

Crimped Leads "LT"

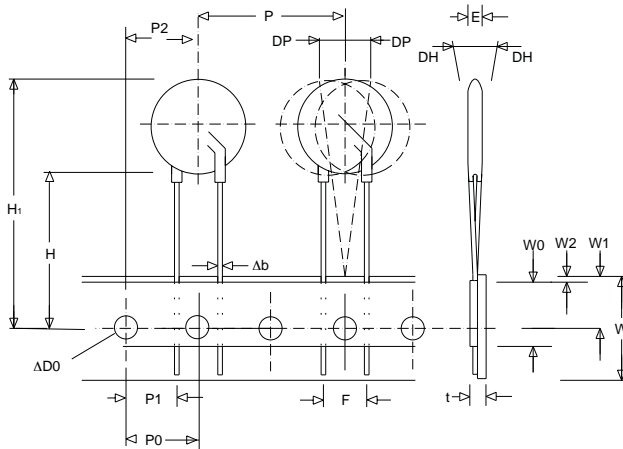

Straight Leads "LS"

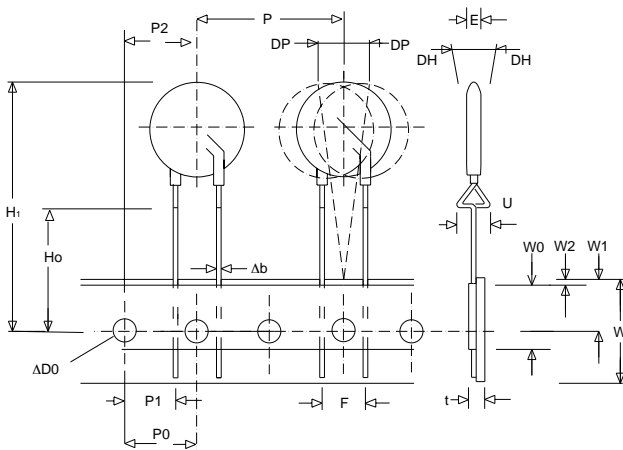

Under-crimped Leads "LU"

SYMBOL	DESCRIPTION	MODEL SIZE		
		10mm	14mm	20mm
P	Pitch of Component	25.4 ± 1.0		
P ₀	Feed Hole Pitch	12.7 ± 0.2		
P ₁	Feed Hole Center to Pitch	8.85 ± 0.8		
P ₂	Hole Center to Component Center	12.7 ± 0.7		
F	Lead to Lead Distance	7.50 ± 0.8		
h	Component Alignment	2.00 Max		
W	Tape Width	18.25 ± 0.75		
W ₀	Hold Down Tape Width	12.0 ± 0.3		
W ₁	Hole Position	9.125 ± 0.625		
W ₂	Hold Down Tape Position	0.5 Max		
H	Height From Tape Center To Component Base	19.0 ± 1.0		
H ₀	Seating Plane Height	16.0 ± 0.5		
H ₁	Component Height	36 Max	40 Max	46.5 Max
D ₀	Feed Hole Diameter	4.0 ± 0.2		
t	Total Tape Thickness	0.7 ± 0.2		
p	Component Alignment	3° Max		
U	Under-crimp Width	8.0 Max		

2
VARISTOR PRODUCTS

Varistor Products

High Energy Radial Lead

RoHS C-III Varistor Series

Tape and Reel Data

- Conforms to ANSI and EIA Specifications
- Can be supplied to IEC publication 286-2
- Radial devices on tape and reel are supplied with either crimped leads, straight leads, or under-crimped leads
- Available for voltage ratings up to 320V only

Tape and Reel Ordering Information

- Crimped leads are standard on LA types supplied in tape and reel and are denoted by the model letter "T". Also, in tape and reel, model letter "S" denotes straight leads and letter "U" denotes special under-crimped leads.

Example:

STANDARD MODEL	CRIMPED LEADS	STRAIGHT LEADS	UNDER CRIMP LEADS
V130LA20C	V130LT20C	V130LS20C	V130LU20C

Shipping Quantity

DEVICE SIZE	VOLTAGE	QUANTITY PER REEL		
		"T" REEL	"S" REEL	"U" REEL
10mm	ALL	500	500	500
14mm	≤ 275 V	500	500	500
	≥ 275V	400	400	400
20mm	≤ 275 V	500	500	500
	≥ 275V	400	400	400

Mechanical Dimensions

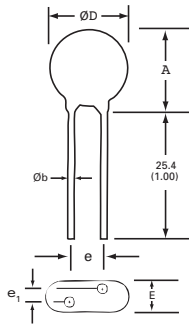

SYMBOL	VRMS VOLTAGE MODEL	VARISTOR MODEL SIZE					
		10mm		14mm		20mm	
		MIN	MAX	MIN	MAX	MIN	MAX
A	ALL	12 (0.472)	16 (0.630)	13.5 (0.531)	20 (0.787)	17.5 (0.689)	26.5 (1.043)
øD	ALL	10 (0.394)	12.5 (0.492)	13.5 (0.531)	17 (0.669)	17.5 (0.689)	23 (0.906)
e	ALL	6.5 (0.256)	8.5 (0.335)	6.5 (0.256)	8.5 (0.335)	6.5 (0.256)	8.5 (0.335)
e1	130 - 320	2.5 (0.098)	5.5 (0.216)	2.5 (0.098)	5.5 (0.216)	2.5 (0.098)	5.5 (0.216)
	>320			4.5 (0.177)	9.0 (0.354)	4.5 (0.177)	9.0 (0.354)
E	130 - 320		7.3 (0.287)		7.3 (0.287)		7.3 (0.287)
	>320				11 (0.433)		11 (0.433)
øb	130 - 660	0.76 (0.030)	0.86 (0.034)	0.76 (0.030)	0.86 (0.034)	0.76 (0.030)	0.86 (0.034)
	>660					0.95 (0.037)	1.05 (0.041)

Dimensions are in millimeters (inches)
 1. 10mm lead spacing also available. See additional lead style options.
 2. 7mm and 12mm devices also available upon request. Contact factory for details.

Additional Lead Style Options

Radial lead types can be supplied with combination preformed crimp and trimmed leads. This option is supplied to the dimensions shown below.

*Seating plane interpretation per IEC-717

SYMBOL	VARISTOR MODEL SIZE					
	10mm		14mm		20mm	
	MIN	MAX	MIN	MAX	MIN	MAX
A	-	19.5 (0.768)	-	23.5 (0.925)	-	30 (1.18)
L _{TRIM}	2.41 (0.095)	4.69 (0.185)	2.41 (0.095)	4.69 (0.185)	2.41 (0.095)	4.69 (0.185)

NOTE: Dimensions are in millimeters (inches).

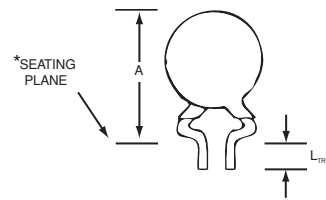

CRIMPED AND TRIMMED LEAD

- To order this crimped and trimmed lead style, the standard radial type model number "LA" is changed to the model number "LC". This option is supplied in bulk only.

Example:

STANDARD MODEL	ORDER AS
V130LA20C	V130LC20C

- For 10 ± 1mm lead spacing on 20mm units only; append standard model numbers by adding "X10" suffix.

Example:

STANDARD MODEL	ORDER AS
V130LA20C	V130LC20CX10

- For other lead style variations to the above, please contact Littelfuse.

Varistor Products

High Energy Radial Lead

RoHS C-III Varistor Series

Ordering Information

C-III series Varistors are shipped standard in bulk pack with straight leads and lead spacing outlined in the package dimensions on page 4-13. Contact your Littelfuse sales representative to discuss the non-standard options outlined below.

For Lead-free and RoHS compliant parts add the letter 'P' after the base part number and before any option as shown in the ordering example below.

ex: V150LS20CP
V300LS40CPX745

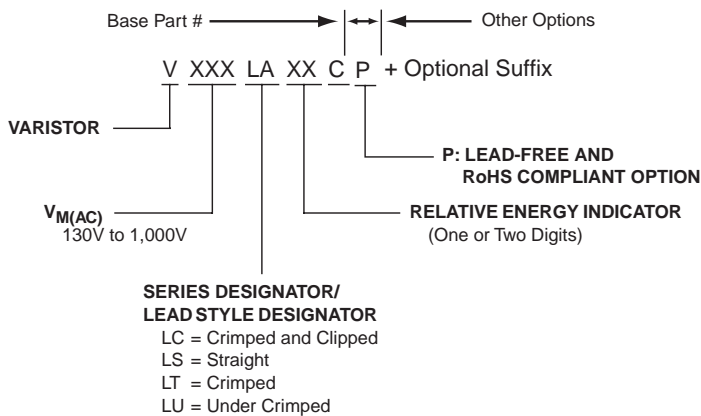

AC Bias Reliability

The C-III series of metal oxide varistors was designed for use on the AC line. The varistor is connected across the AC line and is biased with a constant amplitude sinusoidal voltage. It should be noted that the definition of failure is a shift in the nominal varistor voltage (V_N) exceeding $\pm 10\%$. Although this type of varistor is still functioning normally after this magnitude of shift, devices at the lower extremities of V_N tolerance will begin to dissipate more power.

Because of this possibility, an extensive series of statistically designed tests were performed to determine the reliability of the C-III type of varistor under AC bias combined with high levels of temperature stress. To date, this test has generated over 50,000 device hours of operation at a temperature of 125°C, although only rated at 85°C. Changes in the nominal varistor voltage, measured at 1mA, of less than 2% have been recorded (Figure 8).

Transient Surge Current/Energy Transient Capability

The transient surge rating serves as an excellent figure of merit for the C-III varistor. This inherent surge handling capability is one of the C-III varistor's best features. The enhanced surge absorption capability results from improved process uniformity and enhanced construction. The homogeneity of the raw material powder and improved control over the sintering and assembly processes are contributing factors to this improvement.

In the low power AC mains environment, industry standards (UL, IEC, NEMA and IEEE) all suggest that the worst case surge occurrence will be 3kA. Such a transient event may occur up to five times over the equipment life time (approximately 10 years). While the occurrences of five 3kA transients is the required capability, the rated, repetitive surge current for the C-III series is 80 pulses for the 20mm units and 40 pulses for the

Additionally, all 20mm C-III devices are listed to the "Permanently Connected" category (10kA) of UL1449, by Underwriter's Laboratories, Inc.

As a measure of the inherent device capability, samples of the 20mm V130LA20C devices were subjected to a worst case repetitive transient surges test. After 100 pulses, each of 3kA, there was negligible change in the device characteristics. Changes in the clamping voltage, measured at 100 amps, of less than 3% were recorded (Figure 9). Samples of the 14mm Series V175LA20C were subjected to repetitive surge occurrences of 750A. Again, there was negligible changes in any of the device characteristics after 2000 pulses (Figure 10). In both cases the inherent device capability is far in excess of the expected worst case scenario.

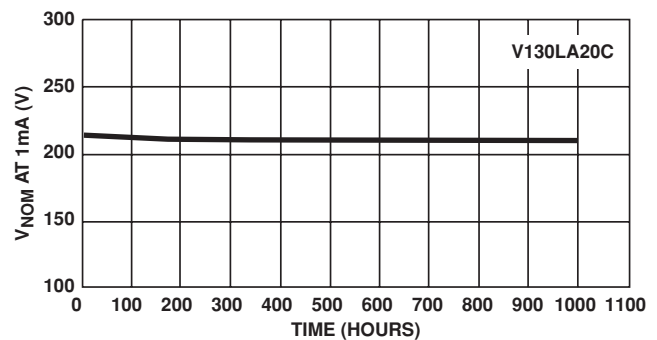

FIGURE 8. HIGH TEMPERATURE OPERATING LIFE 125 °C FOR 1000 HOURS AT RATED BIAS

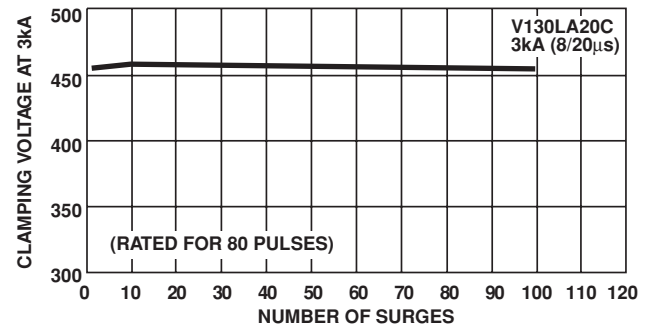

FIGURE 9. TYPICAL REPETITIVE SURGE CURRENT CAPABILITY OF C-III SERIES MOVs

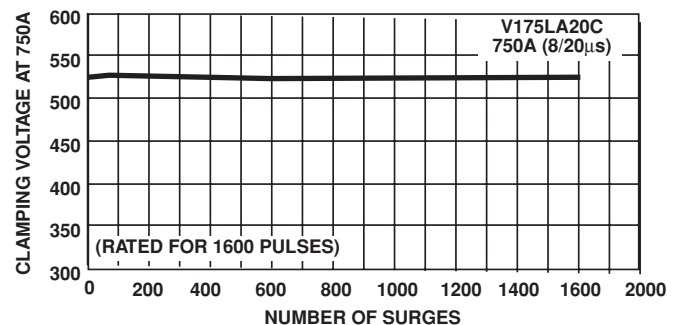

FIGURE 10. TYPICAL REPETITIVE SURGE CURRENT CAPABILITY OF C-III SERIES MOVs