

# Type DCMC 85 °C High Capacitance, Screw Terminal, Aluminum

-40 °C to +85 °C, High Capacitance

[查询"DCMC433U035AD2B"供应商](#)



## Highest Capacitance Screw Terminal Type

With more capacitance and often more ripple-current capability than the best-value Type 3186 capacitor, the Type DCMC capacitor is the better choice for high-capacitance, power supply filters and energy storage applications such as welding equipment, UPS systems and computer hold-up power. The extended cathode foil of the DCMC assures cool operation with heatflow from the capacitor element to the can.

## Highlights

- Highest capacitance value
- Right for Power Supply and UPS systems
- Thermal-Pak™ extended cathode construction

## Specifications

**Operating Temperature:** -40 °C to +85 °C

**Rated Voltage:** 6.3 to 550 Vdc

**Capacitance:** 110 μF to 2.7 F

**Capacitance Tolerance:** -10% +75% up to 100 Vdc, -10 + 50% 160 Vdc & up

**DC Leakage Current:**  $\leq 6\sqrt{CV}$  μA (6 mA max.) at 5 minutes

**Cold Impedence:** -20 °C multiple of 25 °C  $Z \leq 20$  for 6.3–10V, 8 for 16–50V, 4 for 63–100V, 3 for 150V and up.

**Ripple Current Multipliers:**

### Ambient Temperature

| 45 °C | 55 °C | 65 °C | 75 °C | 85 °C |
|-------|-------|-------|-------|-------|
| 2.24  | 2.00  | 1.73  | 1.41  | 1.00  |

### Frequency

|                                      | 50 Hz | 60 Hz | 120 Hz | 360 Hz | 1 kHz | 5 kHz | 10 kHz & up |
|--------------------------------------|-------|-------|--------|--------|-------|-------|-------------|
| <b>1 3/8" &amp; 1 3/4" Diameters</b> |       |       |        |        |       |       |             |
| 6.3 to 160 V                         | 0.92  | 0.94  | 1.00   | 1.05   | 1.10  | 1.10  | 1.12        |
| 200 to 350 V                         | 0.80  | 0.85  | 1.00   | 1.17   | 1.30  | 1.30  | 1.32        |
| 400 to 550 V                         | 0.78  | 0.83  | 1.00   | 1.20   | 1.35  | 1.36  | 1.40        |
| <b>2" &amp; 2 1/2" Diameters</b>     |       |       |        |        |       |       |             |
| 6.3 to 160 V                         | 0.93  | 0.95  | 1.00   | 1.04   | 1.07  | 1.11  | 1.12        |
| 200 to 350 V                         | 0.81  | 0.87  | 1.00   | 1.13   | 1.20  | 1.24  | 1.26        |
| 400 to 550 V                         | 0.79  | 0.83  | 1.00   | 1.17   | 1.26  | 1.30  | 1.34        |
| <b>3" &amp; 3 1/2" Diameters</b>     |       |       |        |        |       |       |             |
| 6.3 to 160 V                         | 0.95  | 0.96  | 1.00   | 1.02   | 1.04  | 1.05  | 1.05        |
| 200 to 350 V                         | 0.85  | 0.88  | 1.00   | 1.08   | 1.12  | 1.14  | 1.17        |
| 400 to 550 V                         | 0.82  | 0.84  | 1.00   | 1.13   | 1.20  | 1.24  | 1.27        |

**EIA Ripple Life:** 2,000 h at full load @ +85 °C per EIA IS-749

ΔCapacitance ±20%

ESR 200% of limit

DCL 100% of limit

**Life Test:** 4,000 h at 85 °C and rated voltage

ΔCapacitance ±20%

ESR 200% of limit

DCL 100% of limit

**Shelf Life:** 500 h @ 85 °C, capacitance, ESR and DCL, initial requirements.

**Vibration:** 10 to 55 Hz, 0.06" and 10g max, 1.5 h ea. of 2 axis



RoHS  
Compliant

Complies with the EU Directive 2002/95/EC requirement restricting the use of Lead (Pb), Mercury (Hg), Cadmium (Cd), Hexavalent chromium (Cr(VI)), PolyBrominated Biphenyls (PBB) and PolyBrominated Diphenyl Ethers (PBDE).



# Type DCMC 85 °C High Capacitance, Screw Terminal, Aluminum

## Outline Drawing

[查询"DCMC433U035AD2B"供应商](#)

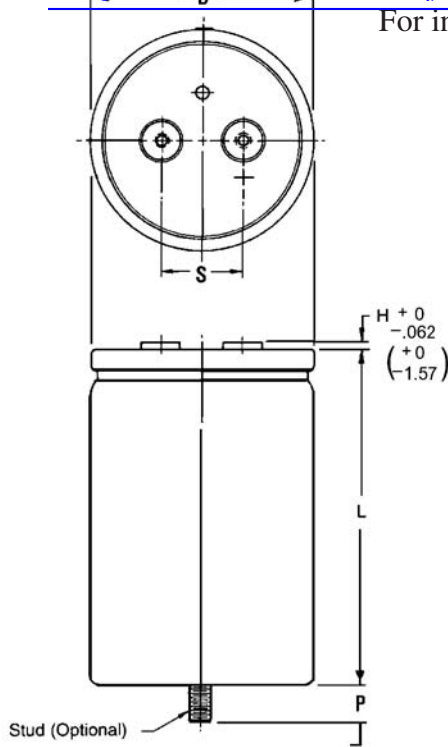

For insulated case, add 0.024" (0.610 mm) to "D" and 0.030" (0.762 mm) to height.

## Case Dimensions

### Uninsulated Case Dimensions

| Case Code | Diam. (D)    |         | Length (L)   |          | Terminals (S) |         | Typical Weight |      |
|-----------|--------------|---------|--------------|----------|---------------|---------|----------------|------|
|           | ±.031 Inches | ±.78 mm | ±.062 Inches | ±1.57 mm | ±0.015 Inches | ±.38 mm | oz             | g    |
| AK        | 1.375        | 34.93   | 1.625        | 41.28    | 0.50          | 12.70   | 1.9            | 54   |
| AA        | 1.375        | 34.93   | 2.125        | 53.98    | 0.50          | 12.70   | 2.0            | 57   |
| AH        | 1.375        | 34.93   | 2.625        | 66.68    | 0.50          | 12.70   | 2.7            | 77   |
| AB        | 1.375        | 34.93   | 3.125        | 79.38    | 0.50          | 12.70   | 3.3            | 94   |
| AJ        | 1.375        | 34.93   | 3.625        | 92.08    | 0.50          | 12.70   | 3.8            | 108  |
| AC        | 1.375        | 34.93   | 4.125        | 104.78   | 0.50          | 12.70   | 4.4            | 125  |
| AD        | 1.375        | 34.93   | 4.625        | 117.48   | 0.50          | 12.70   | 5.1            | 145  |
| AE        | 1.375        | 34.93   | 5.125        | 130.18   | 0.50          | 12.70   | 6.8            | 193  |
| AF        | 1.375        | 34.93   | 5.625        | 142.88   | 0.50          | 12.70   | 8.1            | 230  |
| EA        | 1.750        | 44.45   | 2.125        | 53.98    | 0.75          | 19.05   | 2.7            | 76   |
| EH        | 1.750        | 44.45   | 2.625        | 66.68    | 0.75          | 19.05   | 3.8            | 108  |
| EB        | 1.750        | 44.45   | 3.125        | 79.38    | 0.75          | 19.05   | 5.1            | 145  |
| EJ        | 1.750        | 44.45   | 3.625        | 92.08    | 0.75          | 19.05   | 6.8            | 193  |
| EC        | 1.750        | 44.45   | 4.125        | 104.78   | 0.75          | 19.05   | 8.1            | 230  |
| ED        | 1.750        | 44.45   | 4.625        | 117.48   | 0.75          | 19.05   | 9.0            | 255  |
| EE        | 1.750        | 44.45   | 5.125        | 130.18   | 0.75          | 19.05   | 9.5            | 269  |
| EF        | 1.750        | 44.45   | 5.625        | 142.88   | 0.75          | 19.05   | 10.5           | 298  |
| BA        | 2.000        | 50.80   | 2.125        | 53.98    | 0.88          | 22.23   | 5.4            | 153  |
| BH        | 2.000        | 50.80   | 2.625        | 66.68    | 0.88          | 22.23   | 6.1            | 173  |
| BB        | 2.000        | 50.80   | 3.125        | 79.38    | 0.88          | 22.23   | 6.8            | 193  |
| BJ        | 2.000        | 50.80   | 3.625        | 92.08    | 0.88          | 22.23   | 8.2            | 232  |
| BC        | 2.000        | 50.80   | 4.125        | 104.78   | 0.88          | 22.23   | 9.5            | 269  |
| BD        | 2.000        | 50.80   | 4.625        | 117.48   | 0.88          | 22.23   | 10.3           | 292  |
| BE        | 2.000        | 50.80   | 5.125        | 130.18   | 0.88          | 22.23   | 10.7           | 303  |
| BF        | 2.000        | 50.80   | 5.625        | 142.88   | 0.88          | 22.23   | 13.0           | 369  |
| CH        | 2.500        | 63.50   | 2.625        | 66.68    | 1.13          | 28.58   | 9.2            | 261  |
| CB        | 2.500        | 63.50   | 3.125        | 79.38    | 1.13          | 28.58   | 10.4           | 295  |
| CJ        | 2.500        | 63.50   | 3.625        | 92.08    | 1.13          | 28.58   | 12.7           | 361  |
| CC        | 2.500        | 63.50   | 4.125        | 104.78   | 1.13          | 28.58   | 15.0           | 425  |
| CD        | 2.500        | 63.50   | 4.625        | 117.48   | 1.13          | 28.58   | 17.2           | 488  |
| CE        | 2.500        | 63.50   | 5.125        | 130.18   | 1.13          | 28.58   | 19.3           | 547  |
| CF        | 2.500        | 63.50   | 5.625        | 142.88   | 1.13          | 28.58   | 21.4           | 607  |
| DB        | 3.000        | 76.20   | 3.125        | 79.38    | 1.25          | 31.75   | 16.7           | 473  |
| DJ        | 3.000        | 76.20   | 3.625        | 92.08    | 1.25          | 31.75   | 20.0           | 567  |
| DC        | 3.000        | 76.20   | 4.125        | 104.78   | 1.25          | 31.75   | 22.2           | 629  |
| DD        | 3.000        | 76.20   | 4.625        | 117.48   | 1.25          | 31.75   | 25.5           | 723  |
| DE        | 3.000        | 76.20   | 5.125        | 130.18   | 1.25          | 31.75   | 30.0           | 850  |
| DF        | 3.000        | 76.20   | 5.625        | 142.88   | 1.25          | 31.75   | 31.9           | 904  |
| DP        | 3.000        | 76.20   | 5.875        | 149.23   | 1.25          | 31.75   | 32.8           | 931  |
| DN        | 3.000        | 76.20   | 7.625        | 193.68   | 1.25          | 31.75   | 39.5           | 1119 |
| DG        | 3.000        | 76.20   | 8.625        | 219.08   | 1.25          | 31.75   | 43.3           | 1227 |
| FC        | 3.500        | 88.90   | 4.125        | 104.78   | 1.25          | 31.75   | 30.0           | 850  |
| FD        | 3.500        | 88.90   | 4.625        | 117.48   | 1.25          | 31.75   | 34.4           | 976  |
| FE        | 3.500        | 88.90   | 5.125        | 130.18   | 1.25          | 31.75   | 40.5           | 1148 |
| FF        | 3.500        | 88.90   | 5.625        | 142.88   | 1.25          | 31.75   | 43.1           | 1221 |
| FP        | 3.500        | 88.90   | 5.875        | 149.23   | 1.25          | 31.75   | 44.3           | 1257 |
| FN        | 3.500        | 88.90   | 7.625        | 193.68   | 1.25          | 31.75   | 53.3           | 1512 |
| FG        | 3.500        | 88.90   | 8.625        | 219.08   | 1.25          | 31.75   | 58.5           | 1658 |

NOTE: With the stud-mount feature, a thermally-conductive disk can be inserted in the bottom flush with the outer insulating sleeve. This reduces the thermal resistance through the can bottom by 0.3 °C/W. Can Style P.

### Stud Dimensions

| Case Diam. | Stud Thread | P ± 0.039" (±1.0 mm) |
|------------|-------------|----------------------|
| 1.375      | M8          | 0.470" (12.0)        |
| 1.750      | M8          | 0.470" (12.0)        |
| 2.000      | M12         | 0.630" (16.0)        |
| 2.500      | M12         | 0.630" (16.0)        |
| 3.000      | M12         | 0.630" (16.0)        |
| 3.500      | M12         | 0.630" (16.0)        |

### Terminal Dimensions

| Terminal Style     | For Case Diameters | Code | Post Diameter |      | H max |     | Thread | min Full Thread |      | Torque |      |
|--------------------|--------------------|------|---------------|------|-------|-----|--------|-----------------|------|--------|------|
|                    |                    |      | in            | mm   | in    | mm  |        | in              | mm   | in-lb  | N-m  |
| Low Post           | 1½ to 3            | A    | 0.314         | 8.0  | 0.094 | 2.4 | 10-32  | 0.218           | 5.5  | 25     | 2.82 |
| High Post          | 1½ to 3            | B    | 0.314         | 8.0  | 0.281 | 7.1 | 10-32  | 0.375           | 9.5  | 25     | 2.82 |
| High Current, Low  | 2½ to 3½           | D    | 0.684         | 17.4 | 0.125 | 3.2 | ¼-28   | 0.344           | 8.7  | 60     | 6.78 |
| High Current, High | 2½ to 3½           | E    | 0.684         | 17.4 | 0.281 | 7.1 | ¼-28   | 0.469           | 11.9 | 60     | 6.78 |
| M5 Post, Small     | 1½ to 2            | M    | 0.314         | 8.0  | 0.281 | 7.1 | M5     | 0.375           | 9.5  | 25     | 2.82 |
| M5 Post            | 2½ & 3             | F    | 0.512         | 13.0 | 0.230 | 5.8 | M5     | 0.344           | 8.7  | 25     | 2.82 |
| M6 Low Post        | 2½ to 3½           | G    | 0.684         | 17.4 | 0.125 | 3.2 | M6     | 0.344           | 8.7  | 60     | 6.78 |
| M6 High Post       | 2½ to 3½           | H    | 0.684         | 17.4 | 0.281 | 7.1 | M6     | 0.469           | 11.9 | 60     | 6.78 |

NOTE: Only high post and M5 post terminals are available at 550 Vdc as they meet the required creepage distance.

[Click here to see Hardware & Mounting Options](#)

# Type DCMC 85 °C High Capacitance, Screw Terminal, Aluminum

## Part Numbering System

DCMC 492 II 063 AA 2 B S  
[查询"DCMC433U035AD2B" 供应商](#)

### Type

### Capacitance

100 = 10  $\mu$ F  
 101 = 100  $\mu$ F  
 492 = 4900  $\mu$ F  
 433 = 43,000  $\mu$ F

### Tolerance

M =  $\pm$ 20%  
 U = -10%+75%  
 T = 10%+50%

### Voltage

6R3 = 6.3 Vdc  
 063 = 63 Vdc  
 100 = 100 Vdc

### Case Code

0 = None  
 1 = Polyester  
 2 = PVC

### Terminal

A = Low Post  
 B = High Post  
 D = High Current, Low Post  
 E = High Current, High Post  
 F or M = M5 Post  
 G = M6 Low Post  
 H = M6 High Post

### Can Style

Blank = Standard Can  
 S = Stud  
 P = Stud with Thermal Pad

Polyester insulation is not available for 3.5-inch diameter units.  
 Standard insulation is 0.008-in PVC sleeve with 0.01-in polypropylene end disk.

## Typical Performance Curves

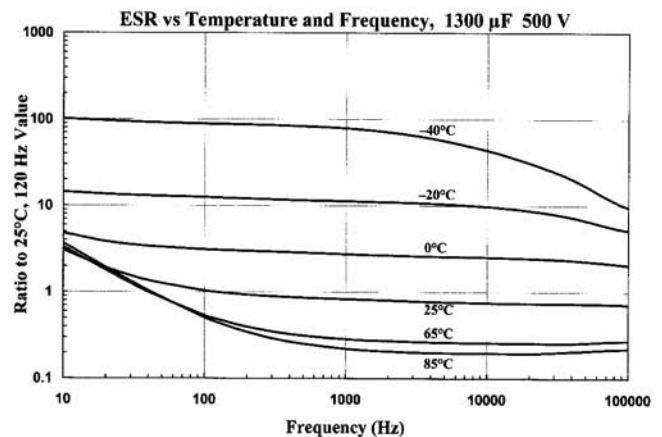
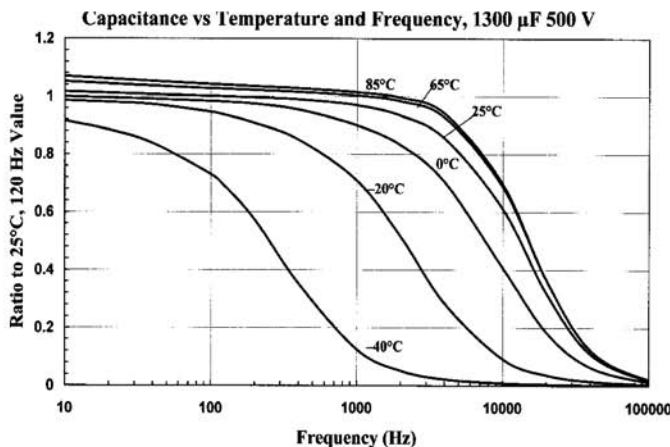
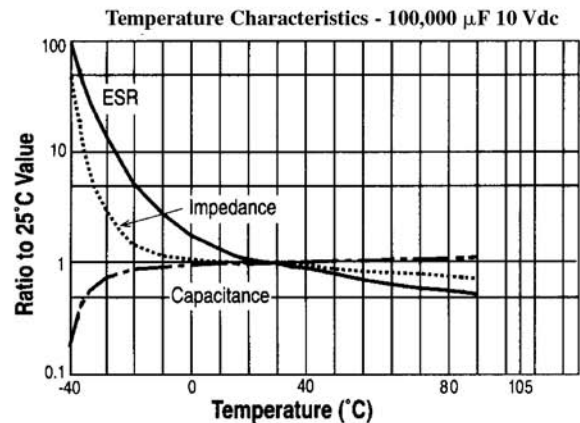
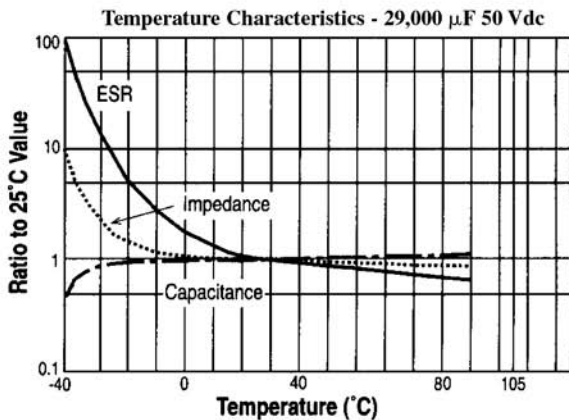
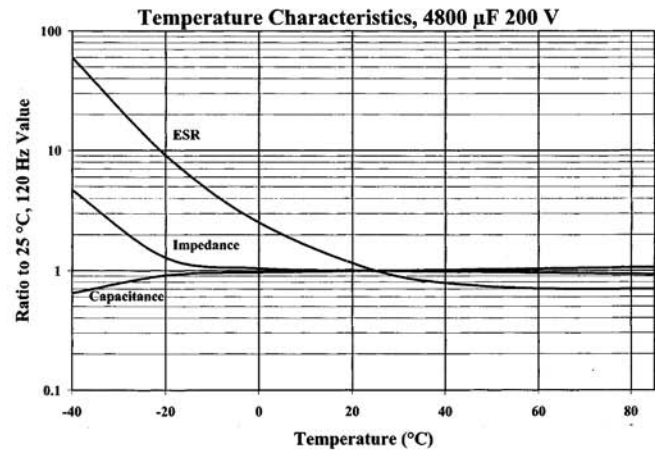
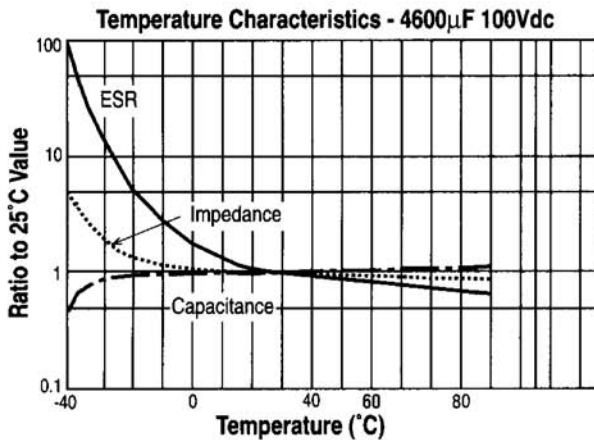

# Type DCMC 85 °C High Capacitance, Screw Terminal, Aluminum

## Typical Performance Curves

[查询"DCMC433U035AD2B"供应商](#)

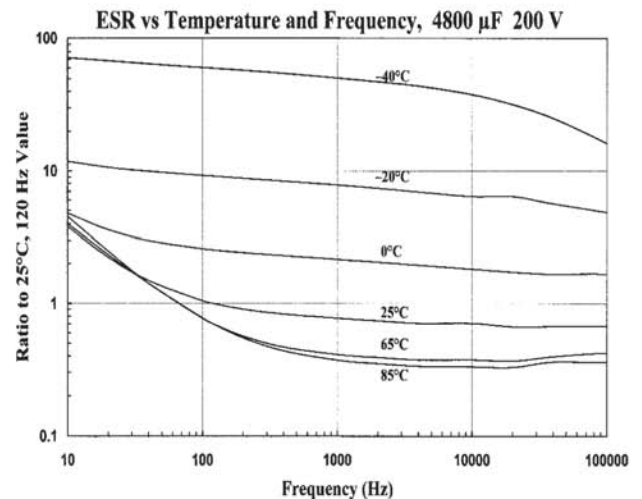
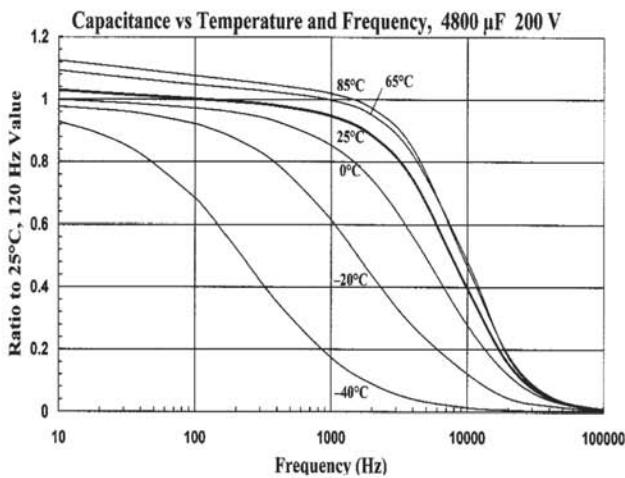
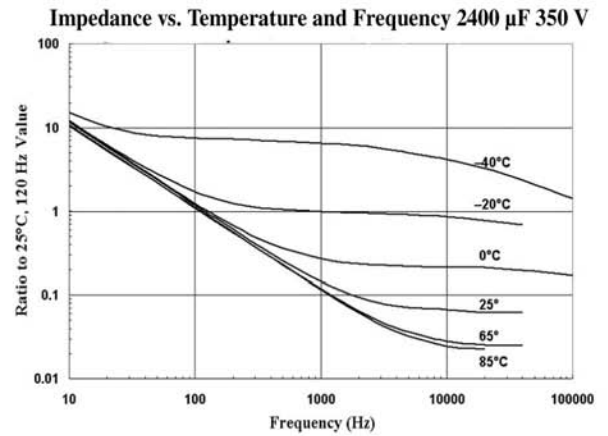
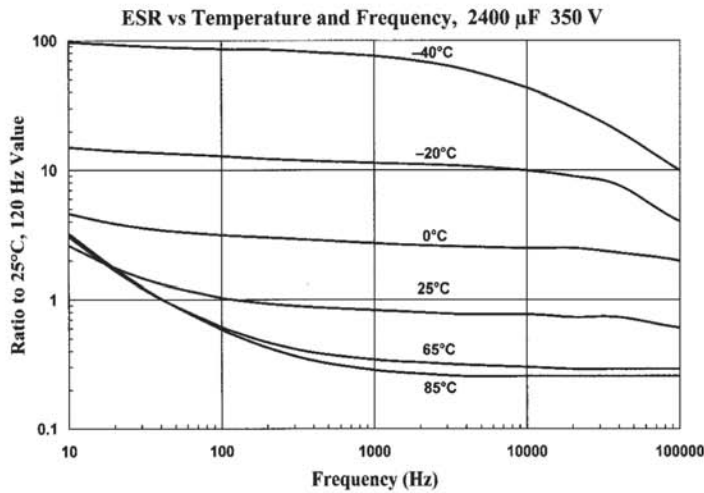
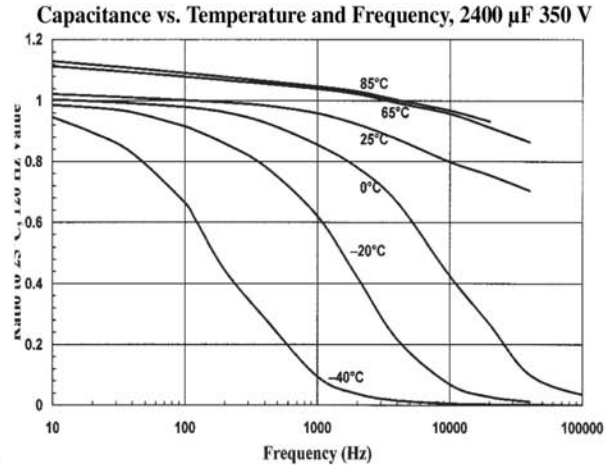
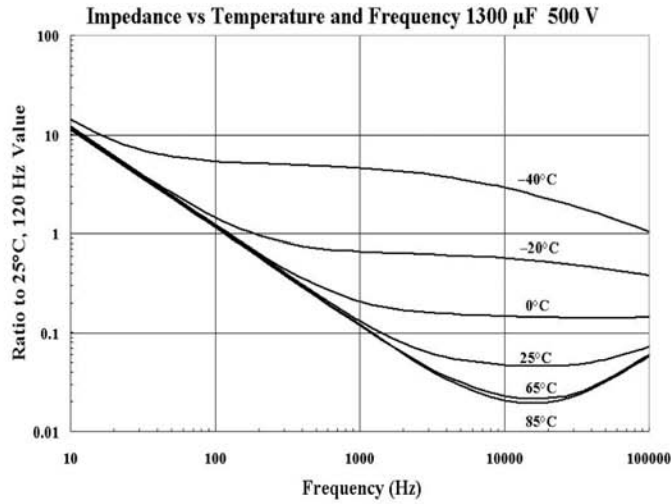

# Type DCMC 85 °C High Capacitance, Screw Terminal, Aluminum

## Typical Performance Curves

[查询"DCMC433U035AD2B"供应商](#)

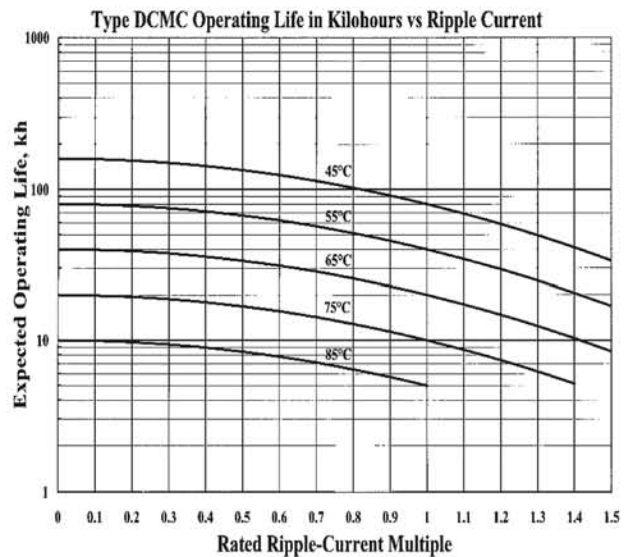
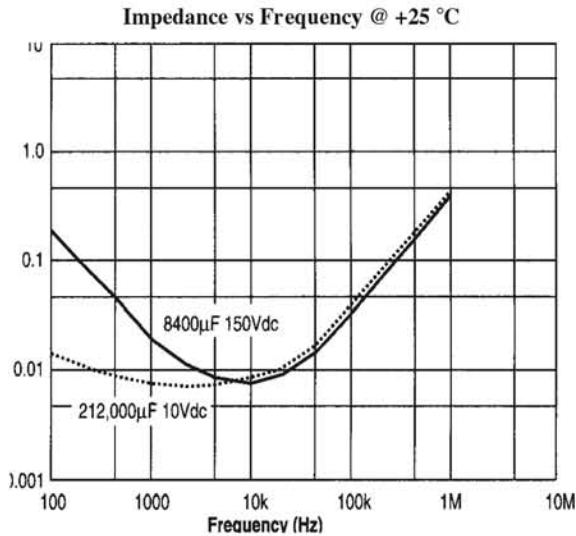
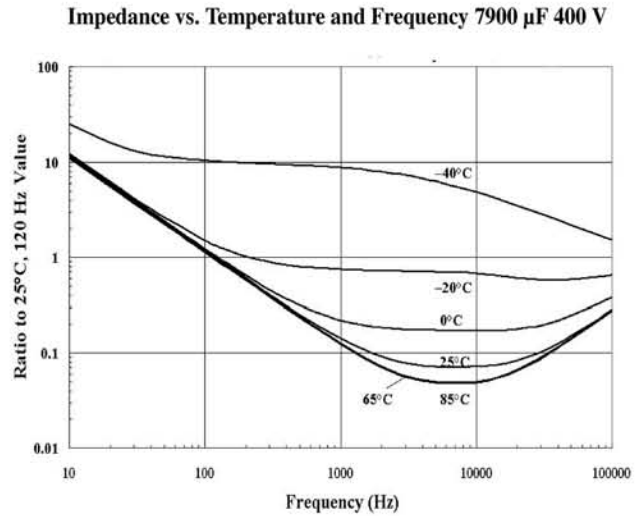
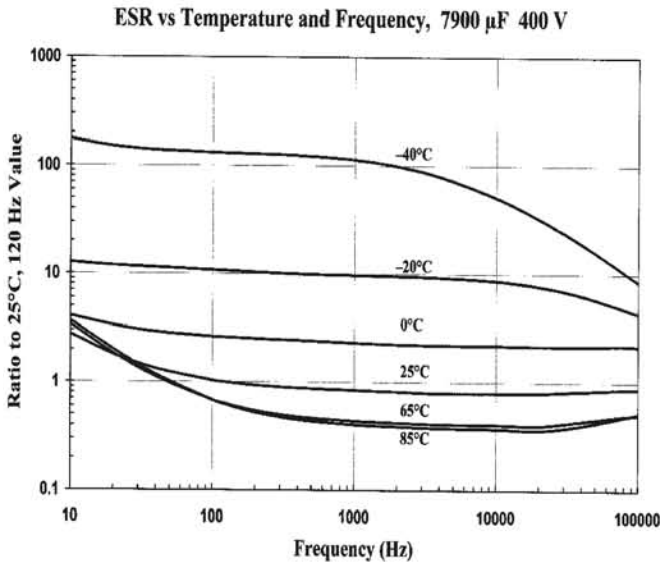
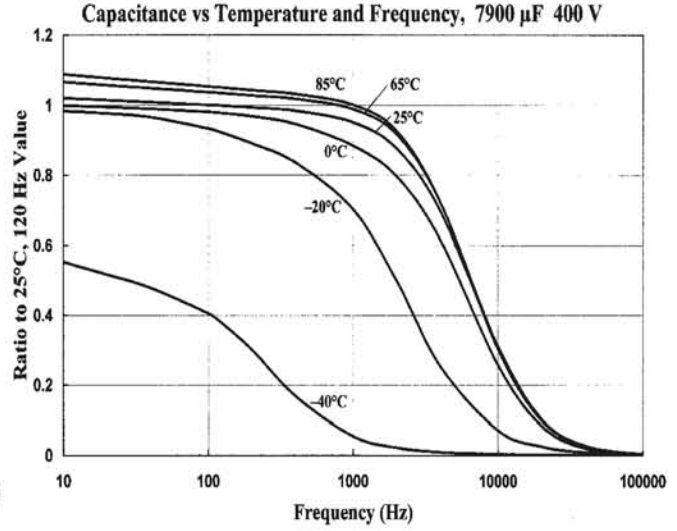
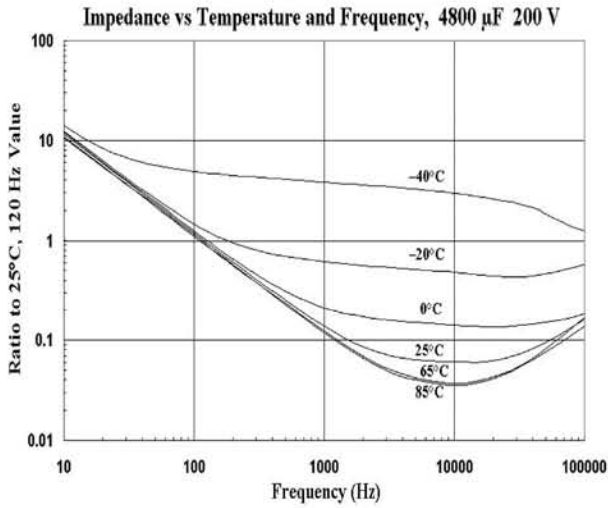

# Type DCMC 85 °C High Capacitance, Screw Terminal, Aluminum Ratings

查询"DCMC433U035A"供应商

| Cap. (µF)                    | Catalog Part Number | ESR Max. @ 25 °C (mΩ) | ESR Max. @ 85 °C (A) | Nominal Size D x L (inches) |
|------------------------------|---------------------|-----------------------|----------------------|-----------------------------|
| <b>6.3 Vdc (8 Vdc Surge)</b> |                     |                       |                      |                             |
| 28000                        | DCMC283U6R3AK2B     | 46.9                  | 4.1                  | 1 3/8 x 1 5/8               |
| 57000                        | DCMC573U6R3AA2B     | 26.5                  | 6.1                  | 1 3/8 x 2 1/8               |
| 68000                        | DCMC683U6R3AH2B     | 18.8                  | 7.8                  | 1 3/8 x 2 5/8               |
| 91000                        | DCMC913U6R3AB2B     | 14.7                  | 9.4                  | 1 3/8 x 3 1/8               |
| 100000                       | DCMC104U6R3EA2B     | 18.8                  | 8.8                  | 1 3/4 x 2 1/8               |
| 110000                       | DCMC114U6R3AJ2B     | 12.8                  | 11.2                 | 1 3/8 x 3 5/8               |
| 120000                       | DCMC124U6R3EH2B     | 14.3                  | 11.0                 | 1 3/4 x 2 5/8               |
| 130000                       | DCMC134U6R3AC2B     | 11.0                  | 13.0                 | 1 3/8 x 4 1/8               |
| 130000                       | DCMC134U6R3BA2B     | 14.2                  | 11.9                 | 2 x 2 1/8                   |
| 150000                       | DCMC154U6R3BH2B     | 9.9                   | 11.6                 | 2 x 2 5/8                   |
| 160000                       | DCMC164U6R3AD2B     | 9.8                   | 12.5                 | 1 3/8 x 4 5/8               |
| 160000                       | DCMC164U6R3EB2B     | 11.0                  | 12.6                 | 1 3/4 x 3 1/8               |
| 180000                       | DCMC184U6R3AE2B     | 8.9                   | 14.7                 | 1 3/8 x 5 1/8               |
| 200000                       | DCMC204U6R3AF2B     | 8.3                   | 16.0                 | 1 3/8 x 5 5/8               |
| 200000                       | DCMC204U6R3EJ2B     | 9.1                   | 15.9                 | 1 3/4 x 3 5/8               |
| 210000                       | DCMC214U6R3BB2B     | 7.8                   | 17.8                 | 2 x 3 1/8                   |
| 240000                       | DCMC244U6R3EC2B     | 7.9                   | 18.3                 | 1 3/4 x 4 1/8               |
| 260000                       | DCMC264U6R3BJ2B     | 6.5                   | 15.6                 | 2 x 3 5/8                   |
| 260000                       | DCMC264U6R3CH2B     | 6.9                   | 16.2                 | 2 1/2 x 2 5/8               |
| 280000                       | DCMC284U6R3ED2B     | 7.0                   | 17.1                 | 1 3/4 x 4 5/8               |
| 310000                       | DCMC314U6R3BC2B     | 5.6                   | 20.2                 | 2 x 4 1/8                   |
| 320000                       | DCMC324U6R3EE2B     | 6.4                   | 19.7                 | 1 3/4 x 5 1/8               |
| 350000                       | DCMC354U6R3CB2B     | 5.3                   | 22.6                 | 2 1/2 x 3 1/8               |
| 360000                       | DCMC364U6R3EF2B     | 6.0                   | 22.0                 | 1 3/4 x 5 5/8               |
| 370000                       | DCMC374U6R3BD2B     | 5.0                   | 24.9                 | 2 x 4 5/8                   |
| 420000                       | DCMC424U6R3BE2B     | 4.5                   | 23.0                 | 2 x 5 1/8                   |
| 440000                       | DCMC444U6R3CJ2B     | 4.3                   | 25.0                 | 2 1/2 x 3 5/8               |
| 470000                       | DCMC474U6R3BF2B     | 4.2                   | 26.7                 | 2 x 5 5/8                   |
| 520000                       | DCMC524U6R3DB2B     | 4.1                   | 28.3                 | 3 x 3 1/8                   |
| 530000                       | DCMC534U6R3CC2D     | 3.8                   | 30.4                 | 2 1/2 x 4 1/8               |
| 610000                       | DCMC614U6R3CD2D     | 3.4                   | 33.4                 | 2 1/2 x 4 5/8               |
| 650000                       | DCMC654U6R3DJ2D     | 3.3                   | 34.6                 | 3 x 3 5/8                   |
| 700000                       | DCMC704U6R3CE2D     | 3.1                   | 33.3                 | 2 1/2 x 5 1/8               |
| 780000                       | DCMC784U6R3DC2D     | 2.9                   | 35.7                 | 3 x 4 1/8                   |
| 790000                       | DCMC794U6R3CF2D     | 2.8                   | 37.9                 | 2 1/2 x 5 5/8               |
| 910000                       | DCMC914U6R3DD2D     | 2.6                   | 41.0                 | 3 x 4 5/8                   |
| 1000000                      | DCMC105U6R3DE2D     | 2.4                   | 44.4                 | 3 x 5 1/8                   |
| 1100000                      | DCMC115U6R3DF2D     | 2.4                   | 45.0                 | 3 x 5 5/8                   |
| 1100000                      | DCMC115U6R3FC2D     | 3.0                   | 41.4                 | 3 1/2 x 4 1/8               |
| 1200000                      | DCMC125U6R3DP2D     | 2.4                   | 51.5                 | 3 x 5 7/8                   |
| 1200000                      | DCMC125U6R3FD2D     | 2.6                   | 43.2                 | 3 1/2 x 4 5/8               |
| 1400000                      | DCMC145U6R3FE2D     | 2.4                   | 47.1                 | 3 1/2 x 5 1/8               |
| 1600000                      | DCMC165U6R3DN2D     | 2.4                   | 49.3                 | 3 x 7 5/8                   |
| 1600000                      | DCMC165U6R3FF2D     | 2.4                   | 47.9                 | 3 1/2 x 5 5/8               |
| 1700000                      | DCMC175U6R3FP2D     | 2.4                   | 49.4                 | 3 1/2 x 5 7/8               |
| 1900000                      | DCMC195U6R3DG2D     | 2.4                   | 49.9                 | 3 x 8 5/8                   |
| 2300000                      | DCMC235U6R3FN2D     | 2.4                   | 54.1                 | 3 1/2 x 7 5/8               |

| Cap. (µF)                    | Catalog Part Number | ESR Max. @ 25 °C (mΩ) | Ripple Max. @ 85 °C (A) | Nominal Size D x L (inches) |
|------------------------------|---------------------|-----------------------|-------------------------|-----------------------------|
| 2700000                      | DCMC275U6R3FG2D     | 2.4                   | 56.5                    | 3 1/2 x 8 5/8               |
| <b>10 Vdc (12 Vdc Surge)</b> |                     |                       |                         |                             |
| 24000                        | DCMC243U010AK2B     | 46.9                  | 4.1                     | 1 3/8 x 1 5/8               |
| 44000                        | DCMC443U010AA2B     | 26.5                  | 6.1                     | 1 3/8 x 2 1/8               |
| 57000                        | DCMC573U010AH2B     | 20.1                  | 7.5                     | 1 3/8 x 2 5/8               |
| 76000                        | DCMC763U010AB2B     | 15.5                  | 9.2                     | 1 3/8 x 3 1/8               |
| 79000                        | DCMC793U010EA2B     | 18.8                  | 8.8                     | 1 3/4 x 2 1/8               |
| 96000                        | DCMC963U010AJ2B     | 12.8                  | 11.2                    | 1 3/8 x 3 5/8               |
| 100000                       | DCMC104U010EH2B     | 14.3                  | 11.0                    | 1 3/4 x 2 5/8               |
| 100000                       | DCMC104U010BA2B     | 17.6                  | 10.3                    | 2 x 2 1/8                   |
| 110000                       | DCMC114U010AC2B     | 11.0                  | 13.5                    | 1 3/8 x 4 1/8               |
| 130000                       | DCMC134U010AD2B     | 9.8                   | 11.6                    | 1 3/8 x 4 5/8               |
| 140000                       | DCMC144U010EB2B     | 11.0                  | 11.8                    | 1 3/4 x 3 1/8               |
| 140000                       | DCMC144U010BH2B     | 13.4                  | 11.4                    | 2 x 2 5/8                   |
| 150000                       | DCMC154U010AE2B     | 8.9                   | 14.7                    | 1 3/8 x 5 1/8               |
| 170000                       | DCMC174U010AF2B     | 8.3                   | 16.0                    | 1 3/8 x 5 5/8               |
| 170000                       | DCMC174U010EJ2B     | 9.1                   | 15.9                    | 1 3/4 x 3 5/8               |
| 180000                       | DCMC184U010BB2B     | 10.5                  | 15.4                    | 2 x 3 1/8                   |
| 210000                       | DCMC214U010EC2B     | 7.9                   | 18.3                    | 1 3/4 x 4 1/8               |
| 220000                       | DCMC224U010BJ2B     | 8.7                   | 13.5                    | 2 x 3 5/8                   |
| 220000                       | DCMC224U010CH2B     | 8.8                   | 14.4                    | 2 1/2 x 2 5/8               |
| 240000                       | DCMC244U010ED2B     | 7.0                   | 17.1                    | 1 3/4 x 4 5/8               |
| 270000                       | DCMC274U010BC2B     | 7.5                   | 17.4                    | 2 x 4 1/8                   |
| 280000                       | DCMC284U010EE2B     | 6.4                   | 19.7                    | 1 3/4 x 5 1/8               |
| 290000                       | DCMC294U010CB2B     | 6.7                   | 20.0                    | 2 1/2 x 3 1/8               |
| 310000                       | DCMC314U010EF2B     | 6.0                   | 22.0                    | 1 3/4 x 5 5/8               |
| 310000                       | DCMC314U010BD2B     | 6.7                   | 21.5                    | 2 x 4 5/8                   |
| 350000                       | DCMC354U010BE2B     | 6.1                   | 19.8                    | 2 x 5 1/8                   |
| 370000                       | DCMC374U010CJ2B     | 5.5                   | 22.1                    | 2 1/2 x 3 5/8               |
| 400000                       | DCMC404U010BF2B     | 5.7                   | 22.9                    | 2 x 5 5/8                   |
| 430000                       | DCMC434U010DB2B     | 4.1                   | 28.3                    | 3 x 3 1/8                   |
| 440000                       | DCMC444U010CC2B     | 4.8                   | 26.9                    | 2 1/2 x 4 1/8               |
| 510000                       | DCMC514U010CD2B     | 4.3                   | 29.5                    | 2 1/2 x 4 5/8               |
| 540000                       | DCMC544U010DJ2D     | 3.3                   | 34.6                    | 3 x 3 5/8                   |
| 590000                       | DCMC594U010CE2B     | 3.9                   | 29.5                    | 2 1/2 x 5 1/8               |
| 640000                       | DCMC644U010DC2D     | 2.9                   | 35.7                    | 3 x 4 1/8                   |
| 660000                       | DCMC664U010CF2D     | 3.6                   | 33.5                    | 2 1/2 x 5 5/8               |
| 750000                       | DCMC754U010DD2D     | 2.6                   | 41.0                    | 3 x 4 5/8                   |
| 860000                       | DCMC864U010DE2D     | 2.4                   | 44.4                    | 3 x 5 1/8                   |
| 900000                       | DCMC904U010FC2D     | 2.9                   | 41.6                    | 3 1/2 x 4 1/8               |
| 940000                       | DCMC944U010DF2D     | 2.3                   | 47.1                    | 3 x 5 5/8                   |
| 1000000                      | DCMC105U010DP2D     | 2.3                   | 52.8                    | 3 x 5 7/8                   |
| 1000000                      | DCMC105U010FD2D     | 2.8                   | 42.0                    | 3 1/2 x 4 5/8               |
| 1200000                      | DCMC125U010FE2D     | 2.5                   | 46.3                    | 3 1/2 x 5 1/8               |
| 1300000                      | DCMC135U010FF2D     | 2.2                   | 50.3                    | 3 1/2 x 5 5/8               |
| 1400000                      | DCMC145U010DN2D     | 2.1                   | 52.7                    | 3 x 7 5/8                   |
| 1400000                      | DCMC145U010FP2D     | 2.1                   | 52.7                    | 3 1/2 x 5 7/8               |
| 1600000                      | DCMC165U010DG2D     | 2.1                   | 54.2                    | 3 x 8 5/8                   |

# Type DCMC 85 °C High Capacitance, Screw Terminal, Aluminum

查询"DCMC433U035AD2B"供应商

| Cap.<br>(µF)                 | Part Number     | ESR Max.<br>@ 25 °C |               | Ripple Max.<br>@ 85 °C |               | Nominal<br>Size<br>D x L<br>(inches) |
|------------------------------|-----------------|---------------------|---------------|------------------------|---------------|--------------------------------------|
|                              |                 | 120 Hz<br>(mΩ)      | 120 Hz<br>(A) | 120 Hz<br>(A)          | 120 Hz<br>(A) |                                      |
| 1900000                      | DCMC195U010FN2D | 1.8                 | 64.3          | 3 1/2 x 7 5/8          |               |                                      |
| 2200000                      | DCMC225U010FG2D | 1.5                 | 70.6          | 3 1/2 x 8 5/8          |               |                                      |
| <b>16 Vdc (20 Vdc Surge)</b> |                 |                     |               |                        |               |                                      |
| 21000                        | DCMC213U016AK2B | 46.9                | 4.1           | 1 3/8 x 1 5/8          |               |                                      |
| 35000                        | DCMC353U016AA2B | 26.5                | 6.1           | 1 3/8 x 2 1/8          |               |                                      |
| 49000                        | DCMC493U016AH2B | 20.1                | 7.5           | 1 3/8 x 2 5/8          |               |                                      |
| 57000                        | DCMC573U016EA2B | 18.8                | 8.3           | 1 3/4 x 2 1/8          |               |                                      |
| 62000                        | DCMC623U016AB2B | 15.5                | 9.7           | 1 3/8 x 3 1/8          |               |                                      |
| 73000                        | DCMC733U016BA2B | 17.6                | 9.5           | 2 x 2 1/8              |               |                                      |
| 76000                        | DCMC763U016AJ2B | 12.8                | 11.7          | 1 3/8 x 3 5/8          |               |                                      |
| 77000                        | DCMC773U016EH2B | 15.3                | 11.1          | 1 3/4 x 2 5/8          |               |                                      |
| 90000                        | DCMC903U016AC2B | 11.0                | 13.5          | 1 3/8 x 4 1/8          |               |                                      |
| 99000                        | DCMC993U016AD2B | 9.8                 | 11.6          | 1 3/8 x 4 5/8          |               |                                      |
| 100000                       | DCMC104U016EB2B | 12.5                | 11.1          | 1 3/4 x 3 1/8          |               |                                      |
| 110000                       | DCMC114U016AE2B | 8.9                 | 14.0          | 1 3/8 x 5 1/8          |               |                                      |
| 110000                       | DCMC114U016BH2B | 13.4                | 12.0          | 2 x 2 5/8              |               |                                      |
| 130000                       | DCMC134U016AF2B | 8.3                 | 16.0          | 1 3/8 x 5 5/8          |               |                                      |
| 130000                       | DCMC134U016EJ2B | 10.9                | 14.6          | 1 3/4 x 3 5/8          |               |                                      |
| 130000                       | DCMC134U016BB2B | 10.5                | 15.4          | 2 x 3 1/8              |               |                                      |
| 150000                       | DCMC154U016EC2B | 9.7                 | 16.5          | 1 3/4 x 4 1/8          |               |                                      |
| 160000                       | DCMC164U016BJ2B | 8.7                 | 13.5          | 2 x 3 5/8              |               |                                      |
| 160000                       | DCMC164U016CH2B | 8.8                 | 14.4          | 2 1/2 x 2 5/8          |               |                                      |
| 180000                       | DCMC184U016ED2B | 8.8                 | 15.3          | 1 3/4 x 4 5/8          |               |                                      |
| 200000                       | DCMC204U016BC2B | 7.5                 | 17.4          | 2 x 4 1/8              |               |                                      |
| 210000                       | DCMC214U016EE2B | 8.2                 | 17.5          | 1 3/4 x 5 1/8          |               |                                      |
| 220000                       | DCMC224U016CB2B | 6.7                 | 20.0          | 2 1/2 x 3 1/8          |               |                                      |
| 230000                       | DCMC234U016EF2B | 7.8                 | 19.3          | 1 3/4 x 5 5/8          |               |                                      |
| 230000                       | DCMC234U016BD2B | 6.7                 | 21.5          | 2 x 4 5/8              |               |                                      |
| 260000                       | DCMC264U016BE2B | 6.1                 | 19.8          | 2 x 5 1/8              |               |                                      |
| 270000                       | DCMC274U016CJ2B | 5.5                 | 22.1          | 2 1/2 x 3 5/8          |               |                                      |
| 290000                       | DCMC294U016BF2B | 5.7                 | 22.9          | 2 x 5 5/8              |               |                                      |
| 320000                       | DCMC324U016CC2B | 5.0                 | 25.6          | 2 1/2 x 4 1/8          |               |                                      |
| 320000                       | DCMC324U016DB2B | 4.2                 | 28.9          | 3 x 3 1/8              |               |                                      |
| 380000                       | DCMC384U016CD2B | 4.6                 | 28.5          | 2 1/2 x 4 5/8          |               |                                      |
| 400000                       | DCMC404U016DJ2D | 3.6                 | 33.3          | 3 x 3 5/8              |               |                                      |
| 430000                       | DCMC434U016CE2B | 4.4                 | 27.9          | 2 1/2 x 5 1/8          |               |                                      |
| 480000                       | DCMC484U016DC2D | 3.3                 | 33.8          | 3 x 4 1/8              |               |                                      |
| 490000                       | DCMC494U016CF2D | 4.2                 | 31.2          | 2 1/2 x 5 5/8          |               |                                      |
| 560000                       | DCMC564U016DD2D | 3.1                 | 37.5          | 3 x 4 5/8              |               |                                      |
| 650000                       | DCMC654U016DE2D | 2.8                 | 40.5          | 3 x 5 1/8              |               |                                      |
| 700000                       | DCMC704U016FC2D | 2.9                 | 41.6          | 3 1/2 x 4 1/8          |               |                                      |
| 710000                       | DCMC714U016DF2D | 2.8                 | 42.8          | 3 x 5 5/8              |               |                                      |
| 750000                       | DCMC754U016DP2D | 2.8                 | 48.3          | 3 x 5 7/8              |               |                                      |
| 810000                       | DCMC814U016FD2D | 2.8                 | 42.1          | 3 1/2 x 4 5/8          |               |                                      |
| 930000                       | DCMC934U016FE2D | 2.5                 | 46.2          | 3 1/2 x 5 1/8          |               |                                      |
| 1000000                      | DCMC105U016FF2D | 2.4                 | 48.3          | 3 1/2 x 5 5/8          |               |                                      |
| 1000000                      | DCMC105U016DN2D | 2.6                 | 47.5          | 3 x 7 5/8              |               |                                      |
| 1500000                      | DCMC155U016FN2D | 2.3                 | 55.4          | 3 1/2 x 7 5/8          |               |                                      |

| Cap.<br>(µF)                 | Catalog<br>Part Number | ESR Max.<br>@ 25 °C |               | Ripple Max.<br>@ 85 °C |               | Nominal<br>Size<br>D x L<br>(inches) |
|------------------------------|------------------------|---------------------|---------------|------------------------|---------------|--------------------------------------|
|                              |                        | 120 Hz<br>(mΩ)      | 120 Hz<br>(A) | 120 Hz<br>(A)          | 120 Hz<br>(A) |                                      |
| 1700000                      | DCMC175U016FG2D        | 2.3                 | 58.2          | 3 1/2 x 8 5/8          |               |                                      |
| <b>25 Vdc (30 Vdc Surge)</b> |                        |                     |               |                        |               |                                      |
| 12000                        | DCMC123U025AK2B        | 37.1                | 4.7           | 1 3/8 x 1 5/8          |               |                                      |
| 20000                        | DCMC203U025AA2B        | 23.6                | 6.5           | 1 3/8 x 2 1/8          |               |                                      |
| 24000                        | DCMC243U025AH2B        | 20.1                | 7.5           | 1 3/8 x 2 5/8          |               |                                      |
| 33000                        | DCMC333U025AB2B        | 19.3                | 8.2           | 1 3/8 x 3 1/8          |               |                                      |
| 36000                        | DCMC363U025EA2B        | 21.8                | 8.2           | 1 3/4 x 2 1/8          |               |                                      |
| 42000                        | DCMC423U025AJ2B        | 19.4                | 9.1           | 1 3/8 x 3 5/8          |               |                                      |
| 43000                        | DCMC433U025EH2B        | 19.4                | 9.5           | 1 3/4 x 2 5/8          |               |                                      |
| 47000                        | DCMC473U025BA2B        | 21.8                | 9.3           | 2 x 2 1/8              |               |                                      |
| 52000                        | DCMC523U025AC2B        | 17.6                | 10.7          | 1 3/8 x 4 1/8          |               |                                      |
| 59000                        | DCMC593U025BH2B        | 16.5                | 9.0           | 2 x 2 5/8              |               |                                      |
| 60000                        | DCMC603U025EB2B        | 15.2                | 10.1          | 1 3/4 x 3 1/8          |               |                                      |
| 61000                        | DCMC613U025AD2B        | 16.4                | 10.3          | 1 3/8 x 4 5/8          |               |                                      |
| 71000                        | DCMC713U025AE2B        | 15.2                | 11.3          | 1 3/8 x 5 1/8          |               |                                      |
| 76000                        | DCMC763U025BB2B        | 12.2                | 13.2          | 2 x 3 1/8              |               |                                      |
| 77000                        | DCMC773U025EJ2B        | 12.8                | 13.4          | 1 3/4 x 3 5/8          |               |                                      |
| 80000                        | DCMC803U025AF2B        | 14.0                | 13.3          | 1 3/8 x 5 5/8          |               |                                      |
| 90000                        | DCMC903U025CH2B        | 9.5                 | 16.7          | 2 1/2 x 2 5/8          |               |                                      |
| 94000                        | DCMC943U025EC2B        | 11.2                | 11.8          | 1 3/4 x 4 1/8          |               |                                      |
| 98000                        | DCMC983U025BJ2B        | 9.8                 | 13.6          | 2 x 3 5/8              |               |                                      |
| 110000                       | DCMC114U025ED2B        | 10.2                | 14.2          | 1 3/4 x 4 5/8          |               |                                      |
| 120000                       | DCMC124U025BC2B        | 8.3                 | 16.6          | 2 x 4 1/8              |               |                                      |
| 130000                       | DCMC134U025EE2B        | 9.6                 | 16.1          | 1 3/4 x 5 1/8          |               |                                      |
| 130000                       | DCMC134U025CB2B        | 7.6                 | 18.9          | 2 1/2 x 3 1/8          |               |                                      |
| 140000                       | DCMC144U025BD2B        | 7.3                 | 19.9          | 2 x 4 5/8              |               |                                      |
| 150000                       | DCMC154U025EF2B        | 9.1                 | 18.4          | 1 3/4 x 5 5/8          |               |                                      |
| 160000                       | DCMC164U025BE2B        | 6.6                 | 19.1          | 2 x 5 1/8              |               |                                      |
| 160000                       | DCMC164U025CJ2B        | 6.4                 | 20.5          | 2 1/2 x 3 5/8          |               |                                      |
| 190000                       | DCMC194U025BF2B        | 6.1                 | 22.2          | 2 x 5 5/8              |               |                                      |
| 190000                       | DCMC194U025DB2B        | 5.0                 | 25.5          | 3 x 3 1/8              |               |                                      |
| 200000                       | DCMC204U025CC2B        | 5.8                 | 24.6          | 2 1/2 x 4 1/8          |               |                                      |
| 230000                       | DCMC234U025CD2B        | 5.2                 | 26.8          | 2 1/2 x 4 5/8          |               |                                      |
| 240000                       | DCMC244U025DJ2D        | 4.3                 | 30.5          | 3 x 3 5/8              |               |                                      |
| 270000                       | DCMC274U025CE2B        | 5.0                 | 26.0          | 2 1/2 x 5 1/8          |               |                                      |
| 300000                       | DCMC304U025DC2D        | 3.9                 | 31.0          | 3 x 4 1/8              |               |                                      |
| 310000                       | DCMC314U025CF2B        | 4.6                 | 29.8          | 2 1/2 x 5 5/8          |               |                                      |
| 350000                       | DCMC354U025DD2D        | 3.5                 | 35.1          | 3 x 4 5/8              |               |                                      |
| 400000                       | DCMC404U025DE2D        | 3.3                 | 37.5          | 3 x 5 1/8              |               |                                      |
| 430000                       | DCMC434U025FC2D        | 3.8                 | 36.0          | 3 1/2 x 4 1/8          |               |                                      |
| 460000                       | DCMC464U025DF2D        | 3.2                 | 39.9          | 3 x 5 5/8              |               |                                      |
| 490000                       | DCMC494U025DP2D        | 3.1                 | 46.0          | 3 x 5 7/8              |               |                                      |
| 500000                       | DCMC504U025FD2D        | 3.5                 | 37.6          | 3 1/2 x 4 5/8          |               |                                      |
| 580000                       | DCMC584U025FE2D        | 3.2                 | 40.3          | 3 1/2 x 5 1/8          |               |                                      |
| 660000                       | DCMC664U025FF2D        | 3.1                 | 42.8          | 3 1/2 x 5 5/8          |               |                                      |
| 670000                       | DCMC674U025DN2D        | 3.1                 | 44.0          | 3 x 7 5/8              |               |                                      |
| 700000                       | DCMC704U025FP2D        | 2.9                 | 44.9          | 3 1/2 x 5 7/8          |               |                                      |
| 780000                       | DCMC784U025DG2D        | 3.0                 | 44.9          | 3 x 8 5/8              |               |                                      |

# Type DCMC 85 °C High Capacitance, Screw Terminal, Aluminum

| Cap.<br>(µF)                 | Catalog<br>Part Number | ESR Max.<br>@ 25 °C<br>120 Hz<br>(mΩ) | ESR Max.<br>@ 85 °C<br>120 Hz<br>(A) | Nominal<br>Size<br>D x L<br>(inches) |
|------------------------------|------------------------|---------------------------------------|--------------------------------------|--------------------------------------|
| 950000                       | DCMC954U025FN2D        | 3.0                                   | 48.7                                 | 3 1/2 x 7 5/8                        |
| 1100000                      | DCMC115U025FG2D        | 2.9                                   | 51.1                                 | 3 1/2 x 8 5/8                        |
| <b>35 Vdc (40 Vdc Surge)</b> |                        |                                       |                                      |                                      |
| 8200                         | DCMC822U035AK2B        | 41.7                                  | 4.4                                  | 1 3/8 x 1 5/8                        |
| 14000                        | DCMC143U035AA2B        | 26.7                                  | 6.1                                  | 1 3/8 x 2 1/8                        |
| 16000                        | DCMC163U035AH2B        | 23.2                                  | 7.0                                  | 1 3/8 x 2 5/8                        |
| 23000                        | DCMC233U035AB2B        | 21.9                                  | 7.7                                  | 1 3/8 x 3 1/8                        |
| 25000                        | DCMC253U035EA2B        | 22.3                                  | 8.1                                  | 1 3/4 x 2 1/8                        |
| 30000                        | DCMC303U035AJ2B        | 21.6                                  | 8.6                                  | 1 3/8 x 3 5/8                        |
| 30000                        | DCMC303U035EH2B        | 19.2                                  | 9.5                                  | 1 3/4 x 2 5/8                        |
| 32000                        | DCMC323U035BA2B        | 24.5                                  | 8.8                                  | 2 x 2 1/8                            |
| 36000                        | DCMC363U035AC2B        | 20.1                                  | 10.0                                 | 1 3/8 x 4 1/8                        |
| 41000                        | DCMC413U035BH2B        | 20.1                                  | 8.1                                  | 2 x 2 5/8                            |
| 42000                        | DCMC423U035EB2B        | 15.5                                  | 10.0                                 | 1 3/4 x 3 1/8                        |
| 43000                        | DCMC433U035AD2B        | 17.8                                  | 9.9                                  | 1 3/8 x 4 5/8                        |
| 49000                        | DCMC493U035AE2B        | 15.5                                  | 11.2                                 | 1 3/8 x 5 1/8                        |
| 53000                        | DCMC533U035BB2B        | 15.9                                  | 11.6                                 | 2 x 3 1/8                            |
| 54000                        | DCMC543U035EJ2B        | 13.2                                  | 13.2                                 | 1 3/4 x 3 5/8                        |
| 56000                        | DCMC563U035AF2B        | 14.1                                  | 13.3                                 | 1 3/8 x 5 5/8                        |
| 63000                        | DCMC633U035CH2B        | 14.8                                  | 13.4                                 | 2 1/2 x 2 5/8                        |
| 66000                        | DCMC663U035EC2B        | 11.8                                  | 11.5                                 | 1 3/4 x 4 1/8                        |
| 69000                        | DCMC693U035BJ2B        | 13.2                                  | 11.7                                 | 2 x 3 5/8                            |
| 78000                        | DCMC783U035ED2B        | 10.6                                  | 13.9                                 | 1 3/4 x 4 5/8                        |
| 84000                        | DCMC843U035BC2B        | 11.6                                  | 14.0                                 | 2 x 4 1/8                            |
| 88000                        | DCMC883U035CB2B        | 11.5                                  | 14.7                                 | 2 1/2 x 3 1/8                        |
| 90000                        | DCMC903U035EE2B        | 9.8                                   | 16.6                                 | 1 3/4 x 5 1/8                        |
| 99000                        | DCMC993U035BD2B        | 10.5                                  | 16.6                                 | 2 x 4 5/8                            |
| 100000                       | DCMC104U035EF2B        | 9.4                                   | 18.1                                 | 1 3/4 x 5 5/8                        |
| 110000                       | DCMC114U035BE2B        | 9.8                                   | 15.6                                 | 2 x 5 1/8                            |
| 110000                       | DCMC114U035CJ2B        | 9.4                                   | 16.9                                 | 2 1/2 x 3 5/8                        |
| 130000                       | DCMC134U035BF2B        | 9.4                                   | 17.9                                 | 2 x 5 5/8                            |
| 130000                       | DCMC134U035DB2B        | 6.9                                   | 21.8                                 | 3 x 3 1/8                            |
| 140000                       | DCMC144U035CC2B        | 8.2                                   | 20.6                                 | 2 1/2 x 4 1/8                        |
| 160000                       | DCMC164U035CD2B        | 7.4                                   | 22.5                                 | 2 1/2 x 4 5/8                        |
| 170000                       | DCMC174U035DJ2B        | 5.7                                   | 26.4                                 | 3 x 3 5/8                            |
| 190000                       | DCMC194U035CE2B        | 6.8                                   | 22.3                                 | 2 1/2 x 5 1/8                        |
| 210000                       | DCMC214U035CF2B        | 6.1                                   | 24.7                                 | 2 1/2 x 5 5/8                        |
| 210000                       | DCMC214U035DC2B        | 5.2                                   | 28.0                                 | 3 x 4 1/8                            |
| 240000                       | DCMC244U035DD2D        | 4.7                                   | 30.5                                 | 3 x 4 5/8                            |
| 280000                       | DCMC284U035DE2D        | 4.4                                   | 32.6                                 | 3 x 5 1/8                            |
| 300000                       | DCMC304U035FC2D        | 4.9                                   | 31.7                                 | 3 1/2 x 4 1/8                        |
| 320000                       | DCMC324U035DF2D        | 4.0                                   | 35.5                                 | 3 x 5 5/8                            |
| 340000                       | DCMC344U035DP2D        | 3.9                                   | 40.9                                 | 3 x 5 7/8                            |
| 350000                       | DCMC354U035FD2D        | 4.5                                   | 33.0                                 | 3 1/2 x 4 5/8                        |
| 410000                       | DCMC414U035FE2D        | 4.0                                   | 36.2                                 | 3 1/2 x 5 1/8                        |
| 460000                       | DCMC464U035FF2D        | 3.6                                   | 39.2                                 | 3 1/2 x 5 5/8                        |
| 470000                       | DCMC474U035DN2D        | 3.8                                   | 39.8                                 | 3 x 7 5/8                            |
| 490000                       | DCMC494U035FP2D        | 3.5                                   | 41.1                                 | 3 1/2 x 5 7/8                        |

| Cap.<br>(µF)                 | Catalog<br>Part Number | ESR Max.<br>@ 25 °C<br>120 Hz<br>(mΩ) | Ripple Max.<br>@ 85 °C<br>120 Hz<br>(A) | Nominal<br>Size<br>D x L<br>(inches) |
|------------------------------|------------------------|---------------------------------------|---|--------------------------------------|
| 550000                       | DCMC554U035DG2D        | 3.6                                   | 40.9                                    | 3 x 8 5/8                            |
| 680000                       | DCMC684U035FN2D        | 3.4                                   | 45.7                                    | 3 1/2 x 7 5/8                        |
| 790000                       | DCMC794U035FG2D        | 3.3                                   | 48.4                                    | 3 1/2 x 8 5/8                        |
| <b>50 Vdc (65 Vdc Surge)</b> |                        |                                       |   |                                      |
| 5900                         | DCMC592U050AK2B        | 47.9                                  | 4.1                                     | 1 3/8 x 1 5/8                        |
| 10000                        | DCMC103U050AA2B        | 30.9                                  | 5.6                                     | 1 3/8 x 2 1/8                        |
| 12000                        | DCMC123U050AH2B        | 25.9                                  | 6.7                                     | 1 3/8 x 2 5/8                        |
| 16000                        | DCMC163U050AB2B        | 23.6                                  | 7.4                                     | 1 3/8 x 3 1/8                        |
| 18000                        | DCMC183U050EA2B        | 22.8                                  | 8.0                                     | 1 3/4 x 2 1/8                        |
| 21000                        | DCMC213U050AJ2B        | 19.6                                  | 9.0                                     | 1 3/8 x 3 5/8                        |
| 21000                        | DCMC213U050EH2B        | 20.2                                  | 9.3                                     | 1 3/4 x 2 5/8                        |
| 23000                        | DCMC233U050BA2B        | 25.3                                  | 8.6                                     | 2 x 2 1/8                            |
| 26000                        | DCMC263U050AC2B        | 18.7                                  | 10.4                                    | 1 3/8 x 4 1/8                        |
| 29000                        | DCMC293U050BH2B        | 20.8                                  | 8.0                                     | 2 x 2 5/8                            |
| 30000                        | DCMC303U050EB2B        | 15.6                                  | 9.9                                     | 1 3/4 x 3 1/8                        |
| 31000                        | DCMC313U050AD2B        | 17.9                                  | 9.9                                     | 1 3/8 x 4 5/8                        |
| 35000                        | DCMC353U050AE2B        | 15.9                                  | 11.0                                    | 1 3/8 x 5 1/8                        |
| 38000                        | DCMC383U050EJ2B        | 13.5                                  | 12.5                                    | 1 3/4 x 3 5/8                        |
| 38000                        | DCMC383U050BB2B        | 16.3                                  | 11.9                                    | 2 x 3 1/8                            |
| 40000                        | DCMC403U050AF2B        | 14.4                                  | 13.1                                    | 1 3/8 x 5 5/8                        |
| 45000                        | DCMC453U050CH2B        | 15.1                                  | 13.3                                    | 2 1/2 x 2 5/8                        |
| 47000                        | DCMC473U050EC2B        | 12.0                                  | 11.4                                    | 1 3/4 x 4 1/8                        |
| 49000                        | DCMC493U050BJ2B        | 13.6                                  | 11.6                                    | 2 x 3 5/8                            |
| 56000                        | DCMC563U050ED2B        | 10.8                                  | 13.8                                    | 1 3/4 x 4 5/8                        |
| 60000                        | DCMC603U050BC2B        | 11.9                                  | 13.8                                    | 2 x 4 1/8                            |
| 63000                        | DCMC633U050CB2B        | 12.0                                  | 14.4                                    | 2 1/2 x 3 1/8                        |
| 64000                        | DCMC643U050EE2B        | 9.8                                   | 16.6                                    | 1 3/4 x 5 1/8                        |
| 71000                        | DCMC713U050BD2B        | 10.8                                  | 16.4                                    | 2 x 4 5/8                            |
| 73000                        | DCMC733U050EF2B        | 9.5                                   | 18.0                                    | 1 3/4 x 5 5/8                        |
| 81000                        | DCMC813U050CJ2B        | 10.3                                  | 15.2                                    | 2 1/2 x 3 5/8                        |
| 82000                        | DCMC823U050BE2B        | 10.0                                  | 16.4                                    | 2 x 5 1/8                            |
| 93000                        | DCMC933U050BF2B        | 9.5                                   | 17.7                                    | 2 x 5 5/8                            |
| 94000                        | DCMC943U050DB2B        | 9.1                                   | 18.9                                    | 3 x 3 1/8                            |
| 99000                        | DCMC993U050CC2B        | 8.9                                   | 19.8                                    | 2 1/2 x 4 1/8                        |
| 120000                       | DCMC124U050CD2B        | 7.9                                   | 21.8                                    | 2 1/2 x 4 5/8                        |
| 120000                       | DCMC124U050DJ2B        | 7.7                                   | 22.7                                    | 3 x 3 5/8                            |
| 130000                       | DCMC134U050CE2B        | 7.2                                   | 21.7                                    | 2 1/2 x 5 1/8                        |
| 150000                       | DCMC154U050CF2B        | 6.7                                   | 23.7                                    | 2 1/2 x 5 5/8                        |
| 150000                       | DCMC154U050DC2B        | 6.9                                   | 24.2                                    | 3 x 4 1/8                            |
| 170000                       | DCMC174U050DD2B        | 6.1                                   | 26.7                                    | 3 x 4 5/8                            |
| 200000                       | DCMC204U050DE2B        | 5.9                                   | 28.1                                    | 3 x 5 1/8                            |
| 200000                       | DCMC204U050FC2D        | 6.4                                   | 27.9                                    | 3 1/2 x 4 1/8                        |
| 230000                       | DCMC234U050DF2D        | 5.6                                   | 30.0                                    | 3 x 5 5/8                            |
| 230000                       | DCMC234U050FD2D        | 5.7                                   | 33.8                                    | 3 1/2 x 4 5/8                        |
| 240000                       | DCMC244U050DP2D        | 5.4                                   | 30.2                                    | 3 x 5 7/8                            |
| 270000                       | DCMC274U050FE2D        | 5.4                                   | 31.3                                    | 3 1/2 x 5 1/8                        |
| 310000                       | DCMC314U050FF2D        | 5.1                                   | 33.2                                    | 3 1/2 x 5 5/8                        |
| 320000                       | DCMC324U050FP2D        | 4.9                                   | 34.8                                    | 3 1/2 x 5 7/8                        |

# Type DCMC 85 °C High Capacitance, Screw Terminal, Aluminum

| Cap. (µF)                    | Catalog Part Number | ESR Max. @ 25°C<br>120 Hz (mΩ) | Ripple Max. @ 85°C<br>120 Hz (A) | Nominal Size<br>D x L (inches) |
|------------------------------|---------------------|--------------------------------|----------------------------------|--------------------------------|
| 350000                       | DCMC354U050DN2D     | 4.5                            | 37.5                             | 3 x 7 5/8                      |
| 390000                       | DCMC394U050DG2D     | 4.1                            | 38.6                             | 3 x 8 5/8                      |
| 450000                       | DCMC454U050FN2D     | 4.2                            | 41.3                             | 3 1/2 x 7 5/8                  |
| 520000                       | DCMC524U050FG2D     | 3.8                            | 44.9                             | 3 1/2 x 8 5/8                  |
| <b>63 Vdc (75 Vdc Surge)</b> |                     |                                |                                  |                                |
| 4100                         | DCMC412U063AK2B     | 60.6                           | 3.6                              | 1 3/8 x 1 5/8                  |
| 7000                         | DCMC702U063AA2B     | 39.0                           | 5.0                              | 1 3/8 x 2 1/8                  |
| 8300                         | DCMC832U063AH2B     | 32.7                           | 5.9                              | 1 3/8 x 2 5/8                  |
| 12000                        | DCMC123U063AB2B     | 28.6                           | 6.8                              | 1 3/8 x 3 1/8                  |
| 13000                        | DCMC133U063EA2B     | 27.9                           | 7.2                              | 1 3/4 x 2 1/8                  |
| 15000                        | DCMC153U063AJ2B     | 26.1                           | 7.8                              | 1 3/8 x 3 5/8                  |
| 15000                        | DCMC153U063EH2B     | 25.6                           | 8.2                              | 1 3/4 x 2 5/8                  |
| 15000                        | DCMC153U063BA2B     | 28.0                           | 8.2                              | 2 x 2 1/8                      |
| 18000                        | DCMC183U063AC2B     | 22.0                           | 9.6                              | 1 3/8 x 4 1/8                  |
| 18000                        | DCMC183U063BH2B     | 22.6                           | 7.7                              | 2 x 2 5/8                      |
| 21000                        | DCMC213U063AD2B     | 19.3                           | 8.9                              | 1 3/8 x 4 5/8                  |
| 21000                        | DCMC213U063EB2B     | 19.5                           | 9.4                              | 1 3/4 x 3 1/8                  |
| 25000                        | DCMC253U063AE2B     | 17.3                           | 10.6                             | 1 3/8 x 5 1/8                  |
| 25000                        | DCMC253U063BB2B     | 18.1                           | 10.8                             | 2 x 3 1/8                      |
| 27000                        | DCMC273U063EJ2B     | 16.2                           | 11.9                             | 1 3/4 x 3 5/8                  |
| 28000                        | DCMC283U063AF2B     | 15.8                           | 12.5                             | 1 3/8 x 5 5/8                  |
| 29000                        | DCMC293U063CH2B     | 26.8                           | 9.9                              | 2 1/2 x 2 5/8                  |
| 32000                        | DCMC323U063BJ2B     | 15.1                           | 10.2                             | 2 x 3 5/8                      |
| 33000                        | DCMC333U063EC2B     | 14.2                           | 11.3                             | 1 3/4 x 4 1/8                  |
| 39000                        | DCMC393U063ED2B     | 12.8                           | 12.7                             | 1 3/4 x 4 5/8                  |
| 39000                        | DCMC393U063BC2B     | 13.3                           | 13.1                             | 2 x 4 1/8                      |
| 41000                        | DCMC413U063CB2B     | 19.3                           | 11.4                             | 2 1/2 x 3 1/8                  |
| 45000                        | DCMC453U063EE2B     | 11.8                           | 15.1                             | 1 3/4 x 5 1/8                  |
| 46000                        | DCMC463U063BD2B     | 12.1                           | 15.5                             | 2 x 4 5/8                      |
| 51000                        | DCMC513U063EF2B     | 11.2                           | 16.6                             | 1 3/4 x 5 5/8                  |
| 52000                        | DCMC523U063CJ2B     | 17.1                           | 11.8                             | 2 1/2 x 3 5/8                  |
| 53000                        | DCMC533U063BE2B     | 11.3                           | 15.5                             | 2 x 5 1/8                      |
| 60000                        | DCMC603U063BF2B     | 10.7                           | 16.7                             | 2 x 5 5/8                      |
| 61000                        | DCMC613U063DB2B     | 14.9                           | 14.8                             | 3 x 3 1/8                      |
| 64000                        | DCMC643U063CC2B     | 13.7                           | 16.0                             | 2 1/2 x 4 1/8                  |
| 76000                        | DCMC763U063CD2B     | 11.8                           | 17.8                             | 2 1/2 x 4 5/8                  |
| 78000                        | DCMC783U063DJ2B     | 12.1                           | 18.1                             | 3 x 3 5/8                      |
| 87000                        | DCMC873U063CE2B     | 11.0                           | 17.6                             | 2 1/2 x 5 1/8                  |
| 95000                        | DCMC953U063DC2B     | 10.8                           | 18.6                             | 3 x 4 1/8                      |
| 99000                        | DCMC993U063CF2B     | 10.5                           | 19.7                             | 2 1/2 x 5 5/8                  |
| 110000                       | DCMC114U063DD2B     | 9.9                            | 21.0                             | 3 x 4 5/8                      |
| 130000                       | DCMC134U063DE2B     | 8.8                            | 23.0                             | 3 x 5 1/8                      |
| 130000                       | DCMC134U063FC2D     | 9.9                            | 22.3                             | 3 1/2 x 4 1/8                  |
| 150000                       | DCMC154U063DF2B     | 7.9                            | 25.3                             | 3 x 5 5/8                      |
| 150000                       | DCMC154U063FD2D     | 9.0                            | 26.8                             | 3 1/2 x 4 5/8                  |
| 160000                       | DCMC164U063DP2B     | 7.5                            | 25.5                             | 3 x 5 7/8                      |
| 180000                       | DCMC184U063FE2D     | 7.9                            | 25.7                             | 3 1/2 x 5 1/8                  |
| 200000                       | DCMC204U063FF2D     | 7.2                            | 28.0                             | 3 1/2 x 5 5/8                  |

| Cap. (µF)                    | Catalog Part Number | ESR Max. @ 25°C<br>120 Hz (mΩ) | Ripple Max. @ 85°C<br>120 Hz (A) | Nominal Size<br>D x L (inches) |
|------------------------------|---------------------|--------------------------------|----------------------------------|--------------------------------|
| 210000                       | DCMC214U063FP2D     | 6.8                            | 29.4                             | 3 1/2 x 5 7/8                  |
| 230000                       | DCMC234U063DN2D     | 6.5                            | 31.2                             | 3 x 7 5/8                      |
| 250000                       | DCMC254U063DG2D     | 5.7                            | 32.6                             | 3 x 8 5/8                      |
| 300000                       | DCMC304U063FN2D     | 5.8                            | 35.3                             | 3 1/2 x 7 5/8                  |
| 350000                       | DCMC354U063FG2D     | 5.2                            | 38.5                             | 3 1/2 x 8 5/8                  |
| <b>75 Vdc (95 Vdc Surge)</b> |                     |                                |                                  |                                |
| 3200                         | DCMC322U075AK2B     | 76.2                           | 3.2                              | 1 3/8 x 1 5/8                  |
| 5300                         | DCMC532U075AA2B     | 50.7                           | 4.4                              | 1 3/8 x 2 1/8                  |
| 6400                         | DCMC642U075AH2B     | 41.7                           | 5.2                              | 1 3/8 x 2 5/8                  |
| 9000                         | DCMC902U075AB2B     | 38.6                           | 5.8                              | 1 3/8 x 3 1/8                  |
| 9900                         | DCMC992U075EA2B     | 55.6                           | 5.1                              | 1 3/4 x 2 1/8                  |
| 12000                        | DCMC123U075AJ2B     | 34.3                           | 6.8                              | 1 3/8 x 3 5/8                  |
| 12000                        | DCMC123U075EH2B     | 47.3                           | 6.1                              | 1 3/4 x 2 5/8                  |
| 12000                        | DCMC123U075BA2B     | 34.8                           | 7.4                              | 2 x 2 1/8                      |
| 14000                        | DCMC143U075AC2B     | 30.5                           | 8.1                              | 1 3/8 x 4 1/8                  |
| 14000                        | DCMC143U075BH2B     | 27.5                           | 6.9                              | 2 x 2 5/8                      |
| 16000                        | DCMC163U075EB2B     | 34.1                           | 6.7                              | 1 3/4 x 3 1/8                  |
| 17000                        | DCMC173U075AD2B     | 26.2                           | 8.2                              | 1 3/8 x 4 5/8                  |
| 19000                        | DCMC193U075AE2B     | 23.8                           | 9.0                              | 1 3/8 x 5 1/8                  |
| 19000                        | DCMC193U075BB2B     | 21.4                           | 10.0                             | 2 x 3 1/8                      |
| 21000                        | DCMC213U075EJ2B     | 26.9                           | 9.3                              | 1 3/4 x 3 5/8                  |
| 22000                        | DCMC223U075AF2B     | 21.4                           | 10.8                             | 1 3/8 x 5 5/8                  |
| 23000                        | DCMC233U075CH2B     | 30.0                           | 9.4                              | 2 1/2 x 2 5/8                  |
| 25000                        | DCMC253U075BJ2B     | 18.0                           | 9.3                              | 2 x 3 5/8                      |
| 26000                        | DCMC263U075EC2B     | 22.3                           | 9.0                              | 1 3/4 x 4 1/8                  |
| 30000                        | DCMC303U075ED2B     | 19.2                           | 10.4                             | 1 3/4 x 4 5/8                  |
| 30000                        | DCMC303U075BC2B     | 15.6                           | 12.1                             | 2 x 4 1/8                      |
| 32000                        | DCMC323U075CB2B     | 21.6                           | 10.7                             | 2 1/2 x 3 1/8                  |
| 35000                        | DCMC353U075EE2B     | 16.9                           | 12.6                             | 1 3/4 x 5 1/8                  |
| 35000                        | DCMC353U075BD2B     | 13.9                           | 14.4                             | 2 x 4 5/8                      |
| 40000                        | DCMC403U075EF2B     | 15.2                           | 14.3                             | 1 3/4 x 5 5/8                  |
| 41000                        | DCMC413U075BE2B     | 12.8                           | 13.7                             | 2 x 5 1/8                      |
| 41000                        | DCMC413U075CJ2B     | 17.8                           | 12.3                             | 2 1/2 x 3 5/8                  |
| 46000                        | DCMC463U075BF2B     | 12.0                           | 15.8                             | 2 x 5 5/8                      |
| 47000                        | DCMC473U075DB2B     | 18.0                           | 13.4                             | 3 x 3 1/8                      |
| 50000                        | DCMC503U075CC2B     | 15.1                           | 15.2                             | 2 1/2 x 4 1/8                  |
| 59000                        | DCMC593U075CD2B     | 13.5                           | 16.7                             | 2 1/2 x 4 5/8                  |
| 61000                        | DCMC613U075DJ2B     | 14.4                           | 16.6                             | 3 x 3 5/8                      |
| 68000                        | DCMC683U075CE2B     | 12.0                           | 16.8                             | 2 1/2 x 5 1/8                  |
| 74000                        | DCMC743U075DC2B     | 12.9                           | 17.0                             | 3 x 4 1/8                      |
| 77000                        | DCMC773U075CF2B     | 11.2                           | 19.0                             | 2 1/2 x 5 5/8                  |
| 88000                        | DCMC883U075DD2B     | 11.8                           | 19.2                             | 3 x 4 5/8                      |
| 100000                       | DCMC104U075DE2B     | 10.4                           | 21.1                             | 3 x 5 1/8                      |
| 100000                       | DCMC104U075FC2D     | 11.8                           | 20.4                             | 3 1/2 x 4 1/8                  |
| 110000                       | DCMC114U075DF2B     | 9.4                            | 23.3                             | 3 x 5 5/8                      |
| 120000                       | DCMC124U075DP2B     | 8.9                            | 26.9                             | 3 x 5 7/8                      |
| 120000                       | DCMC124U075FD2D     | 10.7                           | 21.4                             | 3 1/2 x 4 5/8                  |
| 140000                       | DCMC144U075FE2D     | 9.4                            | 23.7                             | 3 1/2 x 5 1/8                  |

# Type DCMC 85 °C High Capacitance, Screw Terminal, Aluminum

查询"DCMC48U035AD2B"供应商

| Cap. (µF)                      | Part Number     | ESR Max. @ 25°C<br>120 Hz (mΩ) | Ripple Max. @ 5°C<br>120 Hz (A) | Nominal Size D x L (inches) |
|--------------------------------|-----------------|--------------------------------|---------------------------------|-----------------------------|
| 160000                         | DCMC164U075FF2D | 8.4                            | 25.7                            | 3 1/2 x 5 5/8               |
| 170000                         | DCMC174U075DN2D | 7.7                            | 28.1                            | 3 x 7 5/8                   |
| 170000                         | DCMC174U075FP2D | 8.1                            | 27.1                            | 3 1/2 x 5 7/8               |
| 200000                         | DCMC204U075DG2B | 6.8                            | 29.8                            | 3 x 8 5/8                   |
| 230000                         | DCMC234U075FN2D | 6.9                            | 32.3                            | 3 1/2 x 7 5/8               |
| 270000                         | DCMC274U075FG2D | 6.2                            | 35.2                            | 3 1/2 x 8 5/8               |
| <b>100 Vdc (125 Vdc Surge)</b> |                 |                                |                                 |                             |
| 1900                           | DCMC192U100AK2B | 98.4                           | 2.9                             | 1 3/8 x 1 5/8               |
| 3100                           | DCMC312U100AA2B | 60.2                           | 4.0                             | 1 3/8 x 2 1/8               |
| 3900                           | DCMC392U100AH2B | 51.0                           | 4.7                             | 1 3/8 x 2 5/8               |
| 5500                           | DCMC552U100AB2B | 43.4                           | 5.5                             | 1 3/8 x 3 1/8               |
| 6000                           | DCMC602U100EA2B | 62.0                           | 4.8                             | 1 3/4 x 2 1/8               |
| 6300                           | DCMC632U100BA2B | 51.8                           | 5.6                             | 2 x 2 1/8                   |
| 7000                           | DCMC702U100AJ2B | 36.5                           | 6.9                             | 1 3/8 x 3 5/8               |
| 7100                           | DCMC712U100EH2B | 52.8                           | 6.0                             | 1 3/4 x 2 5/8               |
| 8600                           | DCMC862U100AC2B | 33.3                           | 7.8                             | 1 3/8 x 4 1/8               |
| 9000                           | DCMC902U100BH2B | 37.8                           | 5.9                             | 2 x 2 5/8                   |
| 9900                           | DCMC992U100EB2B | 38.0                           | 6.4                             | 1 3/4 x 3 1/8               |
| 10000                          | DCMC103U100AD2B | 31.1                           | 7.5                             | 1 3/8 x 4 5/8               |
| 12000                          | DCMC123U100AE2B | 30.0                           | 8.0                             | 1 3/8 x 5 1/8               |
| 13000                          | DCMC133U100AF2B | 29.0                           | 8.6                             | 1 3/8 x 5 5/8               |
| 13000                          | DCMC133U100EJ2B | 29.9                           | 8.8                             | 1 3/4 x 3 5/8               |
| 13000                          | DCMC133U100BB2B | 30.6                           | 9.0                             | 2 x 3 1/8                   |
| 15000                          | DCMC153U100CH2B | 33.7                           | 8.9                             | 2 1/2 x 2 5/8               |
| 16000                          | DCMC163U100EC2B | 24.8                           | 8.0                             | 1 3/4 x 4 1/8               |
| 16000                          | DCMC163U100BJ2B | 22.3                           | 9.0                             | 2 x 3 5/8                   |
| 18000                          | DCMC183U100ED2B | 21.2                           | 9.8                             | 1 3/4 x 4 5/8               |
| 20000                          | DCMC203U100BC2B | 19.9                           | 10.7                            | 2 x 4 1/8                   |
| 21000                          | DCMC213U100EE2B | 18.7                           | 11.5                            | 1 3/4 x 5 1/8               |
| 21000                          | DCMC213U100CB2B | 23.4                           | 10.7                            | 2 1/2 x 3 1/8               |
| 23000                          | DCMC233U100BD2B | 17.7                           | 12.8                            | 2 x 4 5/8                   |
| 24000                          | DCMC243U100EF2B | 16.8                           | 13.6                            | 1 3/4 x 5 5/8               |
| 27000                          | DCMC273U100BE2B | 15.6                           | 12.4                            | 2 x 5 1/8                   |
| 27000                          | DCMC273U100CJ2B | 19.1                           | 11.9                            | 2 1/2 x 3 5/8               |
| 31000                          | DCMC313U100BF2B | 14.9                           | 14.1                            | 2 x 5 5/8                   |
| 31000                          | DCMC313U100DB2B | 19.9                           | 12.8                            | 3 x 3 1/8                   |
| 33000                          | DCMC333U100CC2B | 16.5                           | 14.6                            | 2 1/2 x 4 1/8               |
| 39000                          | DCMC393U100CD2B | 14.7                           | 16.0                            | 2 1/2 x 4 5/8               |
| 40000                          | DCMC403U100DJ2B | 16.4                           | 15.6                            | 3 x 3 5/8                   |
| 45000                          | DCMC453U100CE2B | 13.4                           | 15.9                            | 2 1/2 x 5 1/8               |
| 49000                          | DCMC493U100DC2B | 14.4                           | 16.1                            | 3 x 4 1/8                   |
| 51000                          | DCMC513U100CF2B | 12.5                           | 18.0                            | 2 1/2 x 5 5/8               |
| 58000                          | DCMC583U100DD2B | 13.0                           | 18.3                            | 3 x 4 5/8                   |
| 67000                          | DCMC673U100DE2B | 12.0                           | 19.7                            | 3 x 5 1/8                   |
| 67000                          | DCMC673U100FC2D | 13.4                           | 19.2                            | 3 1/2 x 4 1/8               |
| 76000                          | DCMC763U100DF2B | 11.2                           | 21.3                            | 3 x 5 5/8                   |
| 79000                          | DCMC793U100FD2D | 12.1                           | 23.1                            | 3 1/2 x 4 5/8               |
| 80000                          | DCMC803U100DP2B | 11.1                           | 21.0                            | 3 x 5 7/8                   |

| Cap. (µF)                      | Catalog Part Number | ESR Max. @ 25 °C<br>120 Hz (mΩ) | Ripple Max. @ 85°C<br>120 Hz (A) | Nominal Size D x L (inches) |
|--------------------------------|---------------------|---------------------------------|----------------------------------|-----------------------------|
| 92000                          | DCMC923U100FE2D     | 10.9                            | 22.0                             | 3 1/2 x 5 1/8               |
| 100000                         | DCMC104U100FF2D     | 10.2                            | 23.4                             | 3 1/2 x 5 5/8               |
| 110000                         | DCMC114U100DN2B     | 9.2                             | 25.8                             | 3 x 7 5/8                   |
| 110000                         | DCMC114U100FP2D     | 10.0                            | 24.3                             | 3 1/2 x 5 7/8               |
| 130000                         | DCMC134U100DG2B     | 8.2                             | 27.3                             | 3 x 8 5/8                   |
| 150000                         | DCMC154U100FN2D     | 8.3                             | 29.5                             | 3 1/2 x 7 5/8               |
| 180000                         | DCMC184U100FG2D     | 7.3                             | 32.3                             | 3 1/2 x 8 5/8               |
| <b>160 Vdc (200 Vdc Surge)</b> |                     |                                 |                                  |                             |
| 1100                           | DCMC112T160AK2B     | 149.6                           | 2.3                              | 1 3/8 x 1 5/8               |
| 1800                           | DCMC182T160AA2B     | 93.0                            | 3.3                              | 1 3/8 x 2 1/8               |
| 2300                           | DCMC232T160AH2B     | 70.5                            | 4.0                              | 1 3/8 x 2 5/8               |
| 3200                           | DCMC322T160AB2B     | 58.5                            | 4.7                              | 1 3/8 x 3 1/8               |
| 3500                           | DCMC352T160EA2B     | 62.0                            | 4.8                              | 1 3/4 x 2 1/8               |
| 3700                           | DCMC372T160BA2B     | 70.5                            | 4.8                              | 2 x 2 1/8                   |
| 4100                           | DCMC412T160AJ2B     | 50.2                            | 5.9                              | 1 3/8 x 3 5/8               |
| 4100                           | DCMC412T160EH2B     | 52.8                            | 6.0                              | 1 3/4 x 2 5/8               |
| 5000                           | DCMC502T160AC2B     | 42.9                            | 6.9                              | 1 3/8 x 4 1/8               |
| 5300                           | DCMC532T160BH2B     | 46.5                            | 5.3                              | 2 x 2 5/8                   |
| 5800                           | DCMC582T160EB2B     | 38.0                            | 6.4                              | 1 3/4 x 3 1/8               |
| 5900                           | DCMC592T160AD2B     | 37.7                            | 6.8                              | 1 3/8 x 4 5/8               |
| 6800                           | DCMC682T160AE2B     | 34.7                            | 7.5                              | 1 3/8 x 5 1/8               |
| 7400                           | DCMC742T160EJ2B     | 29.9                            | 8.4                              | 1 3/4 x 3 5/8               |
| 7400                           | DCMC742T160BB2B     | 33.5                            | 8.3                              | 2 x 3 1/8                   |
| 7700                           | DCMC772T160AF2B     | 32.2                            | 8.8                              | 1 3/8 x 5 5/8               |
| 8300                           | DCMC832T160CH2B     | 30.1                            | 9.4                              | 2 1/2 x 2 5/8               |
| 9100                           | DCMC912T160EC2B     | 24.8                            | 8.0                              | 1 3/4 x 4 1/8               |
| 9500                           | DCMC952T160BJ2B     | 26.4                            | 8.3                              | 2 x 3 5/8                   |
| 11000                          | DCMC113T160ED2B     | 21.2                            | 9.8                              | 1 3/4 x 4 5/8               |
| 12000                          | DCMC123T160EE2B     | 18.7                            | 11.0                             | 1 3/4 x 5 1/8               |
| 12000                          | DCMC123T160BC2B     | 21.9                            | 10.7                             | 2 x 4 1/8                   |
| 12000                          | DCMC123T160CB2B     | 21.3                            | 11.2                             | 2 1/2 x 3 1/8               |
| 14000                          | DCMC143T160EF2B     | 16.8                            | 13.1                             | 1 3/4 x 5 5/8               |
| 14000                          | DCMC143T160BD2B     | 18.8                            | 12.8                             | 2 x 4 5/8                   |
| 15000                          | DCMC153T160CJ2B     | 17.0                            | 11.9                             | 2 1/2 x 3 5/8               |
| 16000                          | DCMC163T160BE2B     | 16.6                            | 12.8                             | 2 x 5 1/8                   |
| 17000                          | DCMC173T160DB2B     | 14.7                            | 14.3                             | 3 x 3 1/8                   |
| 18000                          | DCMC183T160BF2B     | 14.9                            | 14.8                             | 2 x 5 5/8                   |
| 18000                          | DCMC183T160CC2B     | 14.1                            | 15.8                             | 2 1/2 x 4 1/8               |
| 22000                          | DCMC223T160CD2B     | 11.9                            | 17.8                             | 2 1/2 x 4 5/8               |
| 22000                          | DCMC223T160DJ2B     | 11.5                            | 18.6                             | 3 x 3 5/8                   |
| 25000                          | DCMC253T160CE2B     | 10.7                            | 17.8                             | 2 1/2 x 5 1/8               |
| 27000                          | DCMC273T160DC2B     | 9.6                             | 19.7                             | 3 x 4 1/8                   |
| 28000                          | DCMC283T160CF2B     | 9.6                             | 20.5                             | 2 1/2 x 5 5/8               |
| 32000                          | DCMC323T160DD2B     | 8.2                             | 23.0                             | 3 x 4 5/8                   |
| 37000                          | DCMC373T160DE2B     | 7.3                             | 25.3                             | 3 x 5 1/8                   |
| 37000                          | DCMC373T160FC2D     | 9.2                             | 23.2                             | 3 1/2 x 4 1/8               |
| 42000                          | DCMC423T160DF2B     | 6.5                             | 27.9                             | 3 x 5 5/8                   |
| 44000                          | DCMC443T160FD2D     | 7.9                             | 28.6                             | 3 1/2 x 4 5/8               |

# Type DCMC 85 °C High Capacitance, Screw Terminal, Aluminum

| Cap.<br>(µF)                   | Catalog<br>Part Number | ESR Max.<br>@ 25 °C<br>120 Hz<br>(mΩ) | Ripple Max.<br>@ 85 °C<br>120 Hz<br>(A) | Nominal<br>Size<br>D x L<br>(inches) | Cap.<br>(µF)                   | Catalog<br>Part Number | ESR Max.<br>@ 25 °C<br>120 Hz<br>(mΩ) | Ripple Max.<br>@ 85 °C<br>120 Hz<br>(A) | Nominal<br>Size<br>D x L<br>(inches) |
|--------------------------------|------------------------|---------------------------------------|---|--------------------------------------|--------------------------------|------------------------|---------------------------------------|---|--------------------------------------|
| 45000                          | DCMC453T160DP2B        | 6.2                                   | 28.1                                    | 3 x 5 7/8                            | 25000                          | DCMC253T200FD2B        | 15.3                                  | 20.5                                    | 3 1/2 x 4 5/8                        |
| 51000                          | DCMC513T160FE2D        | 6.9                                   | 27.5                                    | 3 1/2 x 5 1/8                        | 26000                          | DCMC263T200DP2B        | 12.7                                  | 19.7                                    | 3 x 5 7/8                            |
| 58000                          | DCMC583T160FF2D        | 6.2                                   | 30.0                                    | 3 1/2 x 5 5/8                        | 28000                          | DCMC283T200FE2B        | 13.4                                  | 19.8                                    | 3 1/2 x 5 1/8                        |
| 61000                          | DCMC613T160FP2D        | 5.9                                   | 31.6                                    | 3 1/2 x 5 7/8                        | 31000                          | DCMC313T200FF2B        | 12.0                                  | 21.6                                    | 3 1/2 x 5 5/8                        |
| 62000                          | DCMC623T160DN2D        | 5.1                                   | 34.9                                    | 3 x 7 5/8                            | 33000                          | DCMC333T200DN2B        | 10.8                                  | 23.7                                    | 3 x 7 5/8                            |
| 72000                          | DCMC723T160DG2D        | 4.3                                   | 37.5                                    | 3 x 8 5/8                            | 33000                          | DCMC333T200FP2D        | 11.5                                  | 22.7                                    | 3 1/2 x 5 7/8                        |
| 85000                          | DCMC853T160FN2D        | 4.9                                   | 38.8                                    | 3 1/2 x 7 5/8                        | 37000                          | DCMC373T200DG2B        | 9.6                                   | 25.2                                    | 3 x 8 5/8                            |
| 99000                          | DCMC993T160FG2D        | 4.2                                   | 42.8                                    | 3 1/2 x 8 5/8                        | 44000                          | DCMC443T200FN2D        | 9.3                                   | 28.2                                    | 3 1/2 x 7 5/8                        |
| <b>200 Vdc (250 Vdc Surge)</b> |                        |                                       |   |                                      | <b>250 Vdc (300 Vdc Surge)</b> |                        |                                       |   |                                      |
| 680                            | DCMC681T200AK2B        | 205.8                                 | 2.0                                     | 1 3/8 x 1 5/8                        | 470                            | DCMC471T250AK2B        | 259.7                                 | 1.8                                     | 1 3/8 x 1 5/8                        |
| 1000                           | DCMC102T200AA2B        | 140.3                                 | 2.6                                     | 1 3/8 x 2 1/8                        | 820                            | DCMC821T250AA2B        | 156.4                                 | 2.5                                     | 1 3/8 x 2 1/8                        |
| 1500                           | DCMC152T200AH2B        | 100.5                                 | 3.4                                     | 1 3/8 x 2 5/8                        | 1200                           | DCMC122T250AH2B        | 118.7                                 | 3.1                                     | 1 3/8 x 2 5/8                        |
| 1800                           | DCMC182T200AB2B        | 78.5                                  | 4.1                                     | 1 3/8 x 3 1/8                        | 1400                           | DCMC142T250EA2B        | 99.0                                  | 3.6                                     | 1 3/4 x 2 1/8                        |
| 1900                           | DCMC192T200EA2B        | 79.1                                  | 4.3                                     | 1 3/4 x 2 1/8                        | 1500                           | DCMC152T250AB2B        | 88.0                                  | 4.1                                     | 1 3/8 x 3 1/8                        |
| 2200                           | DCMC222T200AJ2B        | 63.9                                  | 5.0                                     | 1 3/8 x 3 5/8                        | 1800                           | DCMC182T250EH2B        | 83.3                                  | 4.4                                     | 1 3/4 x 2 5/8                        |
| 2400                           | DCMC242T200EH2B        | 62.5                                  | 5.3                                     | 1 3/4 x 2 5/8                        | 1800                           | DCMC182T250BA2B        | 94.7                                  | 4.3                                     | 2 x 2 1/8                            |
| 2500                           | DCMC252T200BA2B        | 82.0                                  | 4.8                                     | 2 x 2 1/8                            | 1900                           | DCMC192T250AJ2B        | 69.5                                  | 5.2                                     | 1 3/8 x 3 5/8                        |
| 2700                           | DCMC272T200AC2B        | 51.7                                  | 6.2                                     | 1 3/8 x 4 1/8                        | 2300                           | DCMC232T250AC2B        | 57.9                                  | 5.9                                     | 1 3/8 x 4 1/8                        |
| 3100                           | DCMC312T200EB2B        | 48.4                                  | 5.2                                     | 1 3/4 x 3 1/8                        | 2300                           | DCMC232T250EB2B        | 61.3                                  | 4.6                                     | 1 3/4 x 3 1/8                        |
| 3300                           | DCMC332T200AD2B        | 43.2                                  | 6.0                                     | 1 3/8 x 4 5/8                        | 2400                           | DCMC242T250AD2B        | 51.4                                  | 5.5                                     | 1 3/8 x 4 5/8                        |
| 3300                           | DCMC332T200BH2B        | 61.0                                  | 5.3                                     | 2 x 2 5/8                            | 2500                           | DCMC252T250BH2B        | 65.7                                  | 5.2                                     | 2 x 2 5/8                            |
| 3800                           | DCMC382T200EJ2B        | 37.9                                  | 7.2                                     | 1 3/4 x 3 5/8                        | 2700                           | DCMC272T250AE2B        | 44.0                                  | 6.6                                     | 1 3/8 x 5 1/8                        |
| 3900                           | DCMC392T200AE2B        | 37.8                                  | 7.5                                     | 1 3/8 x 5 1/8                        | 3000                           | DCMC302T250EJ2B        | 48.7                                  | 6.6                                     | 1 3/4 x 3 5/8                        |
| 4300                           | DCMC432T200BB2B        | 46.1                                  | 7.1                                     | 2 x 3 1/8                            | 3300                           | DCMC332T250BB2B        | 46.2                                  | 7.1                                     | 2 x 3 1/8                            |
| 4500                           | DCMC452T200AF2B        | 33.4                                  | 8.6                                     | 1 3/8 x 5 5/8                        | 3400                           | DCMC342T250AF2B        | 38.3                                  | 8.0                                     | 1 3/8 x 5 5/8                        |
| 4600                           | DCMC462T200EC2B        | 31.3                                  | 9.2                                     | 1 3/4 x 4 1/8                        | 3700                           | DCMC372T250EC2B        | 40.5                                  | 8.1                                     | 1 3/4 x 4 1/8                        |
| 5400                           | DCMC542T200ED2B        | 26.8                                  | 7.7                                     | 1 3/4 x 4 5/8                        | 3900                           | DCMC392T250ED2B        | 34.8                                  | 6.7                                     | 1 3/4 x 4 5/8                        |
| 5500                           | DCMC552T200CH2B        | 42.2                                  | 6.6                                     | 2 1/2 x 2 5/8                        | 3900                           | DCMC392T250BJ2B        | 38.2                                  | 6.9                                     | 2 x 3 5/8                            |
| 5600                           | DCMC562T200BJ2B        | 36.2                                  | 7.5                                     | 2 x 3 5/8                            | 4100                           | DCMC412T250CH2B        | 51.8                                  | 6.3                                     | 2 1/2 x 2 5/8                        |
| 6100                           | DCMC612T200EE2B        | 23.5                                  | 9.9                                     | 1 3/4 x 5 1/8                        | 4500                           | DCMC452T250EE2B        | 30.6                                  | 8.6                                     | 1 3/4 x 5 1/8                        |
| 6900                           | DCMC692T200EF2B        | 21.0                                  | 10.9                                    | 1 3/4 x 5 5/8                        | 4700                           | DCMC472T250BC2B        | 31.5                                  | 8.9                                     | 2 x 4 1/8                            |
| 6900                           | DCMC692T200BC2B        | 28.5                                  | 9.7                                     | 2 x 4 1/8                            | 5000                           | DCMC502T250EF2B        | 27.3                                  | 9.9                                     | 1 3/4 x 5 5/8                        |
| 7100                           | DCMC712T200CB2B        | 31.2                                  | 9.6                                     | 2 1/2 x 3 1/8                        | 5200                           | DCMC522T250CB2B        | 32.1                                  | 9.5                                     | 2 1/2 x 3 1/8                        |
| 8200                           | DCMC822T200BD2B        | 24.4                                  | 11.2                                    | 2 x 4 5/8                            | 5600                           | DCMC562T250BD2B        | 26.9                                  | 10.7                                    | 2 x 4 5/8                            |
| 9100                           | DCMC912T200BE2B        | 21.7                                  | 10.5                                    | 2 x 5 1/8                            | 6200                           | DCMC622T250BE2B        | 23.6                                  | 10.1                                    | 2 x 5 1/8                            |
| 10000                          | DCMC103T200BF2B        | 19.6                                  | 11.7                                    | 2 x 5 5/8                            | 6400                           | DCMC642T250CJ2B        | 25.1                                  | 10.4                                    | 2 1/2 x 3 5/8                        |
| 10000                          | DCMC103T200CJ2B        | 22.3                                  | 11.6                                    | 2 1/2 x 3 5/8                        | 6800                           | DCMC682T250BF2B        | 21.2                                  | 11.9                                    | 2 x 5 5/8                            |
| 11000                          | DCMC113T200CC2B        | 20.3                                  | 12.7                                    | 2 1/2 x 4 1/8                        | 7800                           | DCMC782T250DB2B        | 27.6                                  | 10.9                                    | 3 x 3 1/8                            |
| 11000                          | DCMC113T200DB2B        | 30.3                                  | 10.8                                    | 3 x 3 1/8                            | 8200                           | DCMC822T250CC2B        | 20.8                                  | 13.0                                    | 2 1/2 x 4 1/8                        |
| 12000                          | DCMC123T200CD2B        | 17.3                                  | 14.7                                    | 2 1/2 x 4 5/8                        | 10000                          | DCMC103T250CD2B        | 17.8                                  | 14.5                                    | 2 1/2 x 4 5/8                        |
| 13000                          | DCMC133T200CE2B        | 15.8                                  | 15.9                                    | 2 1/2 x 5 1/8                        | 10000                          | DCMC103T250DJ2B        | 21.6                                  | 13.6                                    | 3 x 3 5/8                            |
| 13000                          | DCMC133T200DJ2B        | 23.7                                  | 12.0                                    | 3 x 3 5/8                            | 11000                          | DCMC113T250CE2B        | 15.5                                  | 14.8                                    | 2 1/2 x 5 1/8                        |
| 15000                          | DCMC153T200CF2B        | 13.7                                  | 16.5                                    | 2 1/2 x 5 5/8                        | 12000                          | DCMC123T250CF2B        | 13.8                                  | 16.5                                    | 2 1/2 x 5 5/8                        |
| 15000                          | DCMC153T200DC2B        | 19.7                                  | 14.3                                    | 3 x 4 1/8                            | 12000                          | DCMC123T250DC2B        | 17.6                                  | 15.2                                    | 3 x 4 1/8                            |
| 18000                          | DCMC183T200DD2B        | 16.9                                  | 16.1                                    | 3 x 4 5/8                            | 13000                          | DCMC133T250DD2B        | 16.3                                  | 16.4                                    | 3 x 4 5/8                            |
| 21000                          | DCMC213T200FC2B        | 17.1                                  | 16.5                                    | 3 1/2 x 4 1/8                        | 15000                          | DCMC153T250DE2B        | 14.3                                  | 18.0                                    | 3 x 5 1/8                            |
| 22000                          | DCMC223T200DE2B        | 14.8                                  | 18.2                                    | 3 x 5 1/8                            | 16000                          | DCMC163T250FC2D        | 19.5                                  | 15.9                                    | 3 1/2 x 4 1/8                        |
| 24000                          | DCMC243T200DF2B        | 13.3                                  | 19.5                                    | 3 x 5 5/8                            |                                |                        |                                       |   |                                      |

# Type DCMC 85 °C High Capacitance, Screw Terminal, Aluminum

查询"DCMC433U035AD2B" 供应商

| Cap.<br>(µF)                   | Part Number     | ESR Max.<br>@ 25 °C<br>120 Hz<br>(mΩ) | Ripple Max.<br>@ 85 °C<br>120 Hz<br>(A) | Nominal<br>Size<br>D x L<br>(inches) |
|--------------------------------|-----------------|---------------------------------------|---|--------------------------------------|
| 18000                          | DCMC183T250DF2B | 12.0                                  | 20.6                                    | 3 x 5 5/8                            |
| 18000                          | DCMC183T250FD2D | 17.1                                  | 19.4                                    | 3 1/2 x 4 5/8                        |
| 19000                          | DCMC193T250DP2B | 11.5                                  | 20.6                                    | 3 x 5 7/8                            |
| 21000                          | DCMC213T250FE2D | 15.1                                  | 18.7                                    | 3 1/2 x 5 1/8                        |
| 23000                          | DCMC233T250FF2D | 13.4                                  | 20.4                                    | 3 1/2 x 5 5/8                        |
| 24000                          | DCMC243T250FP2D | 12.9                                  | 21.4                                    | 3 1/2 x 5 7/8                        |
| 27000                          | DCMC273T250DN2D | 9.5                                   | 27.2                                    | 3 x 7 5/8                            |
| 30000                          | DCMC303T250DG2B | 7.0                                   | 29.6                                    | 3 x 8 5/8                            |
| 33000                          | DCMC333T250FN2D | 10.6                                  | 26.2                                    | 3 1/2 x 7 5/8                        |
| 38000                          | DCMC383T250FG2D | 9.2                                   | 28.8                                    | 3 1/2 x 8 5/8                        |
| <b>300 Vdc (350 Vdc Surge)</b> |                 |                                       |   |                                      |
| 330                            | DCMC331T300AK2B | 418.1                                 | 1.4                                     | 1 3/8 x 1 5/8                        |
| 600                            | DCMC601T300AA2B | 231.4                                 | 2.1                                     | 1 3/8 x 2 1/8                        |
| 730                            | DCMC731T300AH2B | 188.8                                 | 2.5                                     | 1 3/8 x 2 5/8                        |
| 1000                           | DCMC102T300AB2B | 137.5                                 | 3.1                                     | 1 3/8 x 3 1/8                        |
| 1000                           | DCMC102T300EA2B | 139.3                                 | 3.2                                     | 1 3/4 x 2 1/8                        |
| 1200                           | DCMC122T300EH2B | 117.2                                 | 3.7                                     | 1 3/4 x 2 5/8                        |
| 1200                           | DCMC122T300BA2B | 131.1                                 | 3.6                                     | 2 x 2 1/8                            |
| 1300                           | DCMC132T300AJ2B | 106.8                                 | 4.2                                     | 1 3/8 x 3 5/8                        |
| 1500                           | DCMC152T300AC2B | 90.4                                  | 4.7                                     | 1 3/8 x 4 1/8                        |
| 1500                           | DCMC152T300BH2B | 102.6                                 | 3.6                                     | 2 x 2 5/8                            |
| 1700                           | DCMC172T300EB2B | 84.5                                  | 4.3                                     | 1 3/4 x 3 1/8                        |
| 1800                           | DCMC182T300AD2B | 77.4                                  | 4.7                                     | 1 3/8 x 4 5/8                        |
| 2100                           | DCMC212T300AE2B | 65.7                                  | 5.4                                     | 1 3/8 x 5 1/8                        |
| 2100                           | DCMC212T300EJ2B | 68.3                                  | 5.6                                     | 1 3/4 x 3 5/8                        |
| 2200                           | DCMC222T300BB2B | 71.1                                  | 5.7                                     | 2 x 3 1/8                            |
| 2300                           | DCMC232T300AF2B | 60.3                                  | 6.4                                     | 1 3/8 x 5 5/8                        |
| 2600                           | DCMC262T300EC2B | 56.7                                  | 6.8                                     | 1 3/4 x 4 1/8                        |
| 2600                           | DCMC262T300CH2B | 60.5                                  | 5.1                                     | 2 1/2 x 2 5/8                        |
| 2800                           | DCMC282T300BJ2B | 55.5                                  | 5.7                                     | 2 x 3 5/8                            |
| 3000                           | DCMC302T300ED2B | 48.5                                  | 6.5                                     | 1 3/4 x 4 5/8                        |
| 3300                           | DCMC332T300CB2B | 46.5                                  | 7.0                                     | 2 1/2 x 3 1/8                        |
| 3400                           | DCMC342T300BC2B | 45.7                                  | 7.4                                     | 2 x 4 1/8                            |
| 3500                           | DCMC352T300EE2B | 42.5                                  | 8.0                                     | 1 3/4 x 5 1/8                        |
| 3900                           | DCMC392T300EF2B | 37.9                                  | 8.7                                     | 1 3/4 x 5 5/8                        |
| 4000                           | DCMC402T300BD2B | 38.9                                  | 8.9                                     | 2 x 4 5/8                            |
| 4200                           | DCMC422T300CJ2B | 38.1                                  | 7.9                                     | 2 1/2 x 3 5/8                        |
| 4600                           | DCMC462T300BE2B | 34.0                                  | 8.9                                     | 2 x 5 1/8                            |
| 4800                           | DCMC482T300DB2B | 42.8                                  | 8.4                                     | 3 x 3 1/8                            |
| 5200                           | DCMC522T300CC2B | 29.9                                  | 10.4                                    | 2 1/2 x 4 1/8                        |
| 5300                           | DCMC532T300BF2B | 30.2                                  | 10.8                                    | 2 x 5 5/8                            |
| 6000                           | DCMC602T300DJ2B | 34.0                                  | 10.5                                    | 3 x 3 5/8                            |
| 6100                           | DCMC612T300CD2B | 25.5                                  | 12.5                                    | 2 1/2 x 4 5/8                        |
| 7100                           | DCMC712T300CE2B | 22.2                                  | 12.3                                    | 2 1/2 x 5 1/8                        |
| 7400                           | DCMC742T300DC2B | 26.2                                  | 11.9                                    | 3 x 4 1/8                            |
| 8000                           | DCMC802T300CF2B | 19.8                                  | 14.3                                    | 2 1/2 x 5 5/8                        |
| 8700                           | DCMC872T300DD2B | 23.6                                  | 13.6                                    | 3 x 4 5/8                            |
| 10000                          | DCMC103T300DE2B | 20.5                                  | 15.1                                    | 3 x 5 1/8                            |

| Cap.<br>(µF)                   | Part Number     | ESR Max.<br>@ 25 °C<br>120 Hz<br>(mΩ) | Ripple Max.<br>@ 85 °C<br>120 Hz<br>(A) | Nominal<br>Size<br>D x L<br>(inches) |
|--------------------------------|-----------------|---------------------------------------|---|--------------------------------------|
| 10000                          | DCMC103T300FC2D | 21.0                                  | 15.3                                    | 3 1/2 x 4 1/8                        |
| 11000                          | DCMC113T300DF2B | 18.0                                  | 16.8                                    | 3 x 5 5/8                            |
| 12000                          | DCMC123T300DP2B | 17.0                                  | 19.5                                    | 3 x 5 7/8                            |
| 12000                          | DCMC123T300FD2D | 18.2                                  | 16.4                                    | 3 1/2 x 4 5/8                        |
| 13000                          | DCMC133T300FE2D | 16.0                                  | 18.1                                    | 3 1/2 x 5 1/8                        |
| 15000                          | DCMC153T300FF2D | 14.3                                  | 19.8                                    | 3 1/2 x 5 5/8                        |
| 16000                          | DCMC163T300DN2B | 13.2                                  | 21.8                                    | 3 x 7 5/8                            |
| 16000                          | DCMC163T300FP2D | 13.5                                  | 20.9                                    | 3 1/2 x 5 7/8                        |
| 19000                          | DCMC193T300DG2B | 10.8                                  | 23.7                                    | 3 x 8 5/8                            |
| 22000                          | DCMC223T300FN2D | 11.0                                  | 25.9                                    | 3 1/2 x 7 5/8                        |
| 26000                          | DCMC263T300FG2D | 9.3                                   | 28.6                                    | 3 1/2 x 8 5/8                        |
| <b>350 Vdc (400 Vdc Surge)</b> |                 |                                       |   |                                      |
| 220                            | DCMC221T350AK2B | 605.4                                 | 1.2                                     | 1 3/8 x 1 5/8                        |
| 430                            | DCMC431T350AA2B | 378.8                                 | 1.6                                     | 1 3/8 x 2 1/8                        |
| 510                            | DCMC511T350AH2B | 253.0                                 | 2.1                                     | 1 3/8 x 2 5/8                        |
| 680                            | DCMC681T350AB2B | 190.2                                 | 2.6                                     | 1 3/8 x 3 1/8                        |
| 760                            | DCMC761T350EA2B | 176.6                                 | 2.9                                     | 1 3/4 x 2 1/8                        |
| 860                            | DCMC861T350AJ2B | 152.5                                 | 3.2                                     | 1 3/8 x 3 5/8                        |
| 920                            | DCMC921T350EH2B | 161.7                                 | 3.3                                     | 1 3/4 x 2 5/8                        |
| 990                            | DCMC991T350BA2B | 167.6                                 | 3.3                                     | 2 x 2 1/8                            |
| 1000                           | DCMC102T350AC2B | 127.5                                 | 4.0                                     | 1 3/8 x 4 1/8                        |
| 1200                           | DCMC122T350AD2B | 109.6                                 | 3.5                                     | 1 3/8 x 4 5/8                        |
| 1200                           | DCMC122T350EB2B | 124.7                                 | 3.5                                     | 1 3/4 x 3 1/8                        |
| 1200                           | DCMC122T350BH2B | 132.2                                 | 3.6                                     | 2 x 2 5/8                            |
| 1300                           | DCMC132T350AE2B | 97.2                                  | 4.5                                     | 1 3/8 x 5 1/8                        |
| 1500                           | DCMC152T350AF2B | 85.9                                  | 5.0                                     | 1 3/8 x 5 5/8                        |
| 1500                           | DCMC152T350EJ2B | 97.3                                  | 4.9                                     | 1 3/4 x 3 5/8                        |
| 1500                           | DCMC152T350BB2B | 101.5                                 | 4.9                                     | 2 x 3 1/8                            |
| 1800                           | DCMC182T350EC2B | 79.9                                  | 5.8                                     | 1 3/4 x 4 1/8                        |
| 1900                           | DCMC192T350BJ2B | 79.2                                  | 4.4                                     | 2 x 3 5/8                            |
| 2000                           | DCMC202T350CH2B | 86.9                                  | 4.6                                     | 2 1/2 x 2 5/8                        |
| 2100                           | DCMC212T350ED2B | 67.8                                  | 5.5                                     | 1 3/4 x 4 5/8                        |
| 2300                           | DCMC232T350BC2B | 65.1                                  | 5.9                                     | 2 x 4 1/8                            |
| 2400                           | DCMC242T350EE2B | 59.1                                  | 6.5                                     | 1 3/4 x 5 1/8                        |
| 2500                           | DCMC252T350CB2B | 61.0                                  | 6.6                                     | 2 1/2 x 3 1/8                        |
| 2700                           | DCMC272T350EF2B | 52.4                                  | 7.4                                     | 1 3/4 x 5 5/8                        |
| 2700                           | DCMC272T350BD2B | 55.4                                  | 7.5                                     | 2 x 4 5/8                            |
| 3100                           | DCMC312T350BE2B | 48.7                                  | 7.0                                     | 2 x 5 1/8                            |
| 3100                           | DCMC312T350CJ2B | 48.5                                  | 7.5                                     | 2 1/2 x 3 5/8                        |
| 3500                           | DCMC352T350BF2B | 42.8                                  | 8.3                                     | 2 x 5 5/8                            |
| 3700                           | DCMC372T350CC2B | 39.9                                  | 9.0                                     | 2 1/2 x 4 1/8                        |
| 3800                           | DCMC382T350DB2B | 54.0                                  | 8.1                                     | 3 x 3 1/8                            |
| 4200                           | DCMC422T350CD2B | 34.0                                  | 10.5                                    | 2 1/2 x 4 5/8                        |
| 4600                           | DCMC462T350DJ2B | 41.7                                  | 9.8                                     | 3 x 3 5/8                            |
| 4800                           | DCMC482T350CE2B | 29.6                                  | 10.7                                    | 2 1/2 x 5 1/8                        |
| 5400                           | DCMC542T350CF2B | 26.2                                  | 11.9                                    | 2 1/2 x 5 5/8                        |
| 5500                           | DCMC552T350DC2B | 34.7                                  | 10.8                                    | 3 x 4 1/8                            |
| 6300                           | DCMC632T350DD2B | 29.6                                  | 12.2                                    | 3 x 4 5/8                            |

# Type DCMC 85 °C High Capacitance, Screw Terminal, Aluminum

查询"DCMC433U035AD2B"供应商  
Catalog Part Number

| Cap. (µF)                      |                 | ESR Max. @ 25°C 120 Hz (mΩ) | Ripple Max. @ 85°C 120 Hz (A) | Nominal Size D x L (inches) |
|--------------------------------|-----------------|-----------------------------|-------------------------------|-----------------------------|
| 7200                           | DCMC722T350DE2B | 25.8                        | 13.4                          | 3 x 5 1/8                   |
| 7700                           | DCMC772T350FC2D | 29.9                        | 12.8                          | 3 1/2 x 4 1/8               |
| 8200                           | DCMC822T350DF2B | 22.9                        | 14.9                          | 3 x 5 5/8                   |
| 8400                           | DCMC842T350DP2B | 21.7                        | 17.2                          | 3 x 5 7/8                   |
| 8800                           | DCMC882T350FD2D | 25.7                        | 13.8                          | 3 1/2 x 4 5/8               |
| 10000                          | DCMC103T350FE2D | 22.5                        | 15.3                          | 3 1/2 x 5 1/8               |
| 11000                          | DCMC113T350DN2B | 17.1                        | 19.1                          | 3 x 7 5/8                   |
| 11000                          | DCMC113T350FF2D | 20.0                        | 16.7                          | 3 1/2 x 5 5/8               |
| 12000                          | DCMC123T350FP2D | 18.9                        | 17.7                          | 3 1/2 x 5 7/8               |
| 13000                          | DCMC133T350DG2B | 14.2                        | 20.7                          | 3 x 8 5/8                   |
| 16000                          | DCMC163T350FN2D | 14.9                        | 22.3                          | 3 1/2 x 7 5/8               |
| 18000                          | DCMC183T350FG2D | 12.4                        | 24.8                          | 3 1/2 x 8 5/8               |
| <b>400 Vdc (450 Vdc Surge)</b> |                 |                             |                               |                             |
| 180                            | DCMC181T400AK2B | 652.4                       | 1.1                           | 1 3/8 x 1 5/8               |
| 350                            | DCMC351T400AA2B | 408.2                       | 1.6                           | 1 3/8 x 2 1/8               |
| 420                            | DCMC421T400AH2B | 272.6                       | 2.1                           | 1 3/8 x 2 5/8               |
| 570                            | DCMC571T400AB2B | 204.8                       | 2.5                           | 1 3/8 x 3 1/8               |
| 630                            | DCMC631T400EA2B | 189.5                       | 2.8                           | 1 3/4 x 2 1/8               |
| 710                            | DCMC711T400AJ2B | 164.3                       | 3.1                           | 1 3/8 x 3 5/8               |
| 760                            | DCMC761T400EH2B | 173.7                       | 3.2                           | 1 3/4 x 2 5/8               |
| 820                            | DCMC821T400BA2B | 179.3                       | 3.2                           | 2 x 2 1/8                   |
| 850                            | DCMC851T400AC2B | 137.3                       | 3.8                           | 1 3/8 x 4 1/8               |
| 1000                           | DCMC102T400AD2B | 118.0                       | 3.4                           | 1 3/8 x 4 5/8               |
| 1000                           | DCMC102T400EB2B | 134.0                       | 3.4                           | 1 3/4 x 3 1/8               |
| 1000                           | DCMC102T400BH2B | 141.7                       | 3.5                           | 2 x 2 5/8                   |
| 1100                           | DCMC112T400AE2B | 104.6                       | 4.3                           | 1 3/8 x 5 1/8               |
| 1200                           | DCMC122T400AF2B | 92.4                        | 4.8                           | 1 3/8 x 5 5/8               |
| 1200                           | DCMC122T400EJ2B | 106.6                       | 4.6                           | 1 3/4 x 3 5/8               |
| 1300                           | DCMC132T400BB2B | 108.9                       | 4.8                           | 2 x 3 1/8                   |
| 1500                           | DCMC152T400EC2B | 85.8                        | 5.6                           | 1 3/4 x 4 1/8               |
| 1600                           | DCMC162T400BJ2B | 85.0                        | 4.3                           | 2 x 3 5/8                   |
| 1700                           | DCMC172T400ED2B | 74.3                        | 4.9                           | 1 3/4 x 4 5/8               |
| 1700                           | DCMC172T400CH2B | 93.1                        | 4.7                           | 2 1/2 x 2 5/8               |
| 1900                           | DCMC192T400BC2B | 69.8                        | 5.7                           | 2 x 4 1/8                   |
| 2000                           | DCMC202T400EE2B | 63.4                        | 6.3                           | 1 3/4 x 5 1/8               |
| 2100                           | DCMC212T400CB2B | 65.3                        | 6.4                           | 2 1/2 x 3 1/8               |
| 2200                           | DCMC222T400EF2B | 57.3                        | 7.1                           | 1 3/4 x 5 5/8               |
| 2300                           | DCMC232T400BD2B | 59.3                        | 7.2                           | 2 x 4 5/8                   |
| 2600                           | DCMC262T400BE2B | 52.2                        | 6.8                           | 2 x 5 1/8                   |
| 2600                           | DCMC262T400CJ2B | 52.0                        | 7.2                           | 2 1/2 x 3 5/8               |
| 2900                           | DCMC292T400BF2B | 45.9                        | 8.1                           | 2 x 5 5/8                   |
| 3100                           | DCMC312T400CC2B | 42.8                        | 8.7                           | 2 1/2 x 4 1/8               |
| 3200                           | DCMC322T400DB2B | 57.5                        | 7.8                           | 3 x 3 1/8                   |
| 3900                           | DCMC392T400CD2B | 35.6                        | 10.3                          | 2 1/2 x 4 5/8               |
| 3900                           | DCMC392T400DJ2B | 44.9                        | 9.4                           | 3 x 3 5/8                   |
| 4000                           | DCMC402T400CE2B | 31.7                        | 10.3                          | 2 1/2 x 5 1/8               |
| 4700                           | DCMC472T400CF2B | 28.1                        | 11.5                          | 2 1/2 x 5 5/8               |
| 4700                           | DCMC472T400DC2B | 37.0                        | 10.5                          | 3 x 4 1/8                   |

| Cap. (µF)                      | Catalog Part Number | ESR Max. @ 25 °C 120 Hz (mΩ) | Ripple Max. @ 85°C 120 Hz (A) | Nominal Size D x L (inches) |
|--------------------------------|---------------------|------------------------------|-------------------------------|-----------------------------|
| 5300                           | DCMC532T400DD2B     | 31.5                         | 11.8                          | 3 x 4 5/8                   |
| 6000                           | DCMC602T400DE2B     | 27.4                         | 13.0                          | 3 x 5 1/8                   |
| 6400                           | DCMC642T400FC2D     | 31.9                         | 12.4                          | 3 1/2 x 4 1/8               |
| 6800                           | DCMC682T400DF2B     | 24.4                         | 14.4                          | 3 x 5 5/8                   |
| 7100                           | DCMC712T400DP2B     | 23.1                         | 16.7                          | 3 x 5 7/8                   |
| 7400                           | DCMC742T400FD2D     | 27.4                         | 13.4                          | 3 1/2 x 4 5/8               |
| 8400                           | DCMC842T400FE2D     | 23.9                         | 14.8                          | 3 1/2 x 5 1/8               |
| 9400                           | DCMC942T400FF2D     | 21.2                         | 16.2                          | 3 1/2 x 5 5/8               |
| 9600                           | DCMC962T400DN2B     | 18.2                         | 18.6                          | 3 x 7 5/8                   |
| 9900                           | DCMC992T400FP2D     | 20.1                         | 17.2                          | 3 1/2 x 5 7/8               |
| 11000                          | DCMC113T400DG2B     | 15.1                         | 20.1                          | 3 x 8 5/8                   |
| 13000                          | DCMC133T400FN2D     | 15.8                         | 21.7                          | 3 1/2 x 7 5/8               |
| 15000                          | DCMC153T400FG2D     | 13.1                         | 24.1                          | 3 1/2 x 8 5/8               |
| <b>450 Vdc (500 Vdc Surge)</b> |                     |                              |                               |                             |
| 150                            | DCMC151T450AK2B     | 796.7                        | 1.0                           | 1 3/8 x 1 5/8               |
| 270                            | DCMC271T450AA2B     | 437.7                        | 1.5                           | 1 3/8 x 2 1/8               |
| 350                            | DCMC351T450AH2B     | 337.1                        | 1.8                           | 1 3/8 x 2 5/8               |
| 460                            | DCMC461T450EA2B     | 264.2                        | 2.2                           | 1 3/4 x 2 1/8               |
| 470                            | DCMC471T450AB2B     | 253.2                        | 2.4                           | 1 3/8 x 3 1/8               |
| 560                            | DCMC561T450AJ2B     | 203.0                        | 2.8                           | 1 3/8 x 3 5/8               |
| 570                            | DCMC571T450EH2B     | 213.1                        | 2.9                           | 1 3/4 x 2 5/8               |
| 590                            | DCMC591T450BA2B     | 228.4                        | 2.9                           | 2 x 2 1/8                   |
| 680                            | DCMC681T450AC2B     | 169.5                        | 3.4                           | 1 3/8 x 4 1/8               |
| 740                            | DCMC741T450EB2B     | 164.5                        | 2.8                           | 1 3/4 x 3 1/8               |
| 780                            | DCMC781T450BH2B     | 178.0                        | 2.9                           | 2 x 2 5/8                   |
| 820                            | DCMC821T450AD2B     | 145.6                        | 3.5                           | 1 3/8 x 4 5/8               |
| 920                            | DCMC921T450EJ2B     | 130.9                        | 3.8                           | 1 3/4 x 3 5/8               |
| 930                            | DCMC931T450AE2B     | 127.7                        | 4.1                           | 1 3/8 x 5 1/8               |
| 1000                           | DCMC102T450AF2B     | 113.9                        | 4.5                           | 1 3/8 x 5 5/8               |
| 1000                           | DCMC102T450BB2B     | 137.0                        | 4.3                           | 2 x 3 1/8                   |
| 1100                           | DCMC112T450EC2B     | 107.4                        | 5.0                           | 1 3/4 x 4 1/8               |
| 1200                           | DCMC122T450BJ2B     | 109.0                        | 3.8                           | 2 x 3 5/8                   |
| 1200                           | DCMC122T450CH2B     | 115.8                        | 4.0                           | 2 1/2 x 2 5/8               |
| 1300                           | DCMC132T450ED2B     | 91.1                         | 4.7                           | 1 3/4 x 4 5/8               |
| 1500                           | DCMC152T450EE2B     | 79.2                         | 5.4                           | 1 3/4 x 5 1/8               |
| 1500                           | DCMC152T450BC2B     | 89.5                         | 5.3                           | 2 x 4 1/8                   |
| 1700                           | DCMC172T450EF2B     | 70.2                         | 6.2                           | 1 3/4 x 5 5/8               |
| 1700                           | DCMC172T450CB2B     | 81.1                         | 6.0                           | 2 1/2 x 3 1/8               |
| 1800                           | DCMC182T450BD2B     | 76.0                         | 6.4                           | 2 x 4 5/8                   |
| 1900                           | DCMC192T450BE2B     | 66.8                         | 6.0                           | 2 x 5 1/8                   |
| 2000                           | DCMC202T450CJ2B     | 66.5                         | 6.4                           | 2 1/2 x 3 5/8               |
| 2200                           | DCMC222T450BF2B     | 58.6                         | 7.1                           | 2 x 5 5/8                   |
| 2400                           | DCMC242T450CC2B     | 54.7                         | 7.7                           | 2 1/2 x 4 1/8               |
| 2500                           | DCMC252T450DB2B     | 65.7                         | 7.3                           | 3 x 3 1/8                   |
| 2800                           | DCMC282T450CD2B     | 46.4                         | 9.0                           | 2 1/2 x 4 5/8               |
| 3000                           | DCMC302T450DJ2B     | 52.2                         | 8.7                           | 3 x 3 5/8                   |
| 3300                           | DCMC332T450CE2B     | 40.4                         | 9.2                           | 2 1/2 x 5 1/8               |
| 3900                           | DCMC392T450CF2B     | 35.4                         | 10.3                          | 2 1/2 x 5 5/8               |

# Type DCMC 85 °C High Capacitance, Screw Terminal, Aluminum

查询"DCMC488U035AD2B"供应商

| Cap.<br>(µF)                   | Part Number     | ESR Max.                  | Ripple Max.              | Nominal<br>Size<br>D x L<br>(inches) |
|--------------------------------|-----------------|---------------------------|--------------------------|--------------------------------------|
|                                |                 | @ 25 °C<br>120 Hz<br>(mΩ) | @ 85 °C<br>120 Hz<br>(A) |                                      |
| 3900                           | DCMC392T450DC2B | 40.1                      | 10.1                     | 3 x 4 1/8                            |
| 4100                           | DCMC412T450DD2B | 37.5                      | 10.8                     | 3 x 4 5/8                            |
| 4700                           | DCMC472T450DE2B | 32.5                      | 12.0                     | 3 x 5 1/8                            |
| 5000                           | DCMC502T450FC2D | 31.8                      | 12.5                     | 3 1/2 x 4 1/8                        |
| 5600                           | DCMC562T450DF2B | 28.8                      | 13.3                     | 3 x 5 5/8                            |
| 5800                           | DCMC582T450DP2B | 27.3                      | 15.4                     | 3 x 5 7/8                            |
| 5800                           | DCMC582T450FD2D | 27.0                      | 13.5                     | 3 1/2 x 4 5/8                        |
| 6800                           | DCMC682T450FE2D | 23.5                      | 15.0                     | 3 1/2 x 5 1/8                        |
| 7300                           | DCMC732T450FF2D | 21.1                      | 16.3                     | 3 1/2 x 5 5/8                        |
| 7700                           | DCMC772T450FP2D | 20.0                      | 17.2                     | 3 1/2 x 5 7/8                        |
| 7900                           | DCMC792T450DN2B | 21.3                      | 17.1                     | 3 x 7 5/8                            |
| 9000                           | DCMC902T450DG2B | 17.6                      | 18.6                     | 3 x 8 5/8                            |
| 10000                          | DCMC103T450FN2D | 15.9                      | 21.6                     | 3 1/2 x 7 5/8                        |
| 12000                          | DCMC123T450FG2D | 13.3                      | 24.0                     | 3 1/2 x 8 5/8                        |
| <b>500 Vdc (550 Vdc Surge)</b> |                 |                           |                          |                                      |
| 110                            | DCMC111T500AK2B | 1224.3                    | 0.8                      | 1 3/8 x 1 5/8                        |
| 180                            | DCMC181T500AA2B | 736.9                     | 1.2                      | 1 3/8 x 2 1/8                        |
| 240                            | DCMC241T500AH2B | 556.5                     | 1.4                      | 1 3/8 x 2 5/8                        |
| 270                            | DCMC271T500EA2B | 498.4                     | 1.6                      | 1 3/4 x 2 1/8                        |
| 320                            | DCMC321T500AB2B | 409.7                     | 1.9                      | 1 3/8 x 3 1/8                        |
| 340                            | DCMC341T500BA2B | 393.1                     | 2.0                      | 2 x 2 1/8                            |
| 380                            | DCMC381T500EH2B | 347.2                     | 2.2                      | 1 3/4 x 2 5/8                        |
| 400                            | DCMC401T500AJ2B | 338.1                     | 2.4                      | 1 3/8 x 3 5/8                        |
| 470                            | DCMC471T500BH2B | 273.9                     | 2.7                      | 2 x 2 5/8                            |
| 480                            | DCMC481T500AC2B | 293.2                     | 2.1                      | 1 3/8 x 4 1/8                        |
| 500                            | DCMC501T500EB2B | 264.5                     | 2.4                      | 1 3/4 x 3 1/8                        |
| 560                            | DCMC561T500AD2B | 261.2                     | 2.6                      | 1 3/8 x 4 5/8                        |
| 640                            | DCMC641T500AE2B | 231.1                     | 2.9                      | 1 3/8 x 5 1/8                        |
| 650                            | DCMC651T500EJ2B | 202.0                     | 3.2                      | 1 3/4 x 3 5/8                        |
| 700                            | DCMC701T500BB2B | 200.1                     | 3.4                      | 2 x 3 1/8                            |
| 720                            | DCMC721T500AF2B | 195.4                     | 3.6                      | 1 3/8 x 5 5/8                        |
| 790                            | DCMC791T500EC2B | 172.4                     | 3.9                      | 1 3/4 x 4 1/8                        |
| 800                            | DCMC801T500CH2B | 170.6                     | 3.0                      | 2 1/2 x 2 5/8                        |
| 860                            | DCMC861T500BJ2B | 159.1                     | 3.4                      | 2 x 3 5/8                            |
| 930                            | DCMC931T500ED2B | 149.1                     | 3.7                      | 1 3/4 x 4 5/8                        |
| 1000                           | DCMC102T500BC2B | 138.7                     | 4.1                      | 2 x 4 1/8                            |
| 1100                           | DCMC112T500EE2B | 129.6                     | 4.4                      | 1 3/4 x 5 1/8                        |

| Cap.<br>(µF)                   | Catalog<br>Part Number | ESR Max.                  | Ripple Max.              | Nominal Size<br>D x L<br>(inches) |
|--------------------------------|------------------------|---------------------------|--------------------------|-----------------------------------|
|                                |                        | @ 25 °C<br>120 Hz<br>(mΩ) | @ 85 °C<br>120 Hz<br>(A) |                                   |
| 1100                           | DCMC112T500CB2B        | 122.0                     | 4.7                      | 2 1/2 x 3 1/8                     |
| 1200                           | DCMC122T500EF2B        | 114.7                     | 5.0                      | 1 3/4 x 5 5/8                     |
| 1200                           | DCMC122T500BD2B        | 117.7                     | 5.1                      | 2 x 4 5/8                         |
| 1400                           | DCMC142T500BE2B        | 102.3                     | 4.8                      | 2 x 5 1/8                         |
| 1400                           | DCMC142T500CJ2B        | 95.1                      | 5.3                      | 2 1/2 x 3 5/8                     |
| 1500                           | DCMC152T500BF2B        | 93.3                      | 5.7                      | 2 x 5 5/8                         |
| 1700                           | DCMC172T500CC2B        | 79.7                      | 6.4                      | 2 1/2 x 4 1/8                     |
| 1700                           | DCMC172T500DB2B        | 86.4                      | 6.4                      | 3 x 3 1/8                         |
| 2100                           | DCMC212T500CE2B        | 61.1                      | 7.8                      | 2 1/2 x 5 1/8                     |
| 2200                           | DCMC222T500CD2B        | 68.3                      | 7.6                      | 2 1/2 x 4 5/8                     |
| 2200                           | DCMC222T500DJ2B        | 67.4                      | 7.1                      | 3 x 3 5/8                         |
| 2500                           | DCMC252T500CF2B        | 54.7                      | 8.3                      | 2 1/2 x 5 5/8                     |
| 2500                           | DCMC252T500DC2B        | 55.4                      | 8.6                      | 3 x 4 1/8                         |
| 3000                           | DCMC302T500DD2B        | 48.1                      | 9.5                      | 3 x 4 5/8                         |
| 3400                           | DCMC342T500DE2B        | 43.1                      | 10.4                     | 3 x 5 1/8                         |
| 3500                           | DCMC352T500FC2D        | 40.1                      | 11.1                     | 3 1/2 x 4 1/8                     |
| 3900                           | DCMC392T500DF2B        | 37.5                      | 11.6                     | 3 x 5 5/8                         |
| 4100                           | DCMC412T500DP2B        | 35.5                      | 13.5                     | 3 x 5 7/8                         |
| 4100                           | DCMC412T500FD2D        | 34.1                      | 12.0                     | 3 1/2 x 4 5/8                     |
| 4800                           | DCMC482T500FE2D        | 30.0                      | 13.2                     | 3 1/2 x 5 1/8                     |
| 5400                           | DCMC542T500FF2D        | 28.0                      | 14.2                     | 3 1/2 x 5 5/8                     |
| 5700                           | DCMC572T500FP2D        | 26.0                      | 15.1                     | 3 1/2 x 5 7/8                     |
| 5700                           | DCMC572T500DN2B        | 27.9                      | 15.0                     | 3 x 7 5/8                         |
| 6600                           | DCMC662T500DG2B        | 23.1                      | 16.2                     | 3 x 8 5/8                         |
| 7900                           | DCMC792T500FN2D        | 20.5                      | 19.1                     | 3 1/2 x 7 5/8                     |
| 9200                           | DCMC922T500FG2D        | 16.7                      | 21.4                     | 3 1/2 x 8 5/8                     |
| <b>550 Vdc (600 Vdc Surge)</b> |                        |                           |                          |                                   |
| 1400                           | DCMC142T550CC2B        | 170.5                     | 4.9                      | 2 1/2 x 4 1/8                     |
| 1700                           | DCMC172T550CD2B        | 132.6                     | 5.9                      | 2 1/2 x 4 5/8                     |
| 1900                           | DCMC192T550CE2B        | 111.7                     | 6.8                      | 2 1/2 x 5 1/8                     |
| 2200                           | DCMC222T550DC2B        | 90.4                      | 7.8                      | 3 x 4 1/8                         |
| 2300                           | DCMC232T550CF2B        | 86.5                      | 7.8                      | 2 1/2 x 5 5/8                     |
| 2500                           | DCMC252T550DD2B        | 79.6                      | 8.4                      | 3 x 4 5/8                         |
| 2900                           | DCMC292T550DE2B        | 64.0                      | 9.7                      | 3 x 5 1/8                         |
| 3400                           | DCMC342T550DF2B        | 54.6                      | 10.9                     | 3 x 5 5/8                         |
| 3700                           | DCMC372T550DP2B        | 50.2                      | 12.2                     | 3 x 5 7/8                         |
| 5100                           | DCMC512T550DN2B        | 36.4                      | 16.2                     | 3 x 7 5/8                         |