

Series 2890R
2890
 查询"2890R-12K" 供应商
Molded Unshielded RF Coils

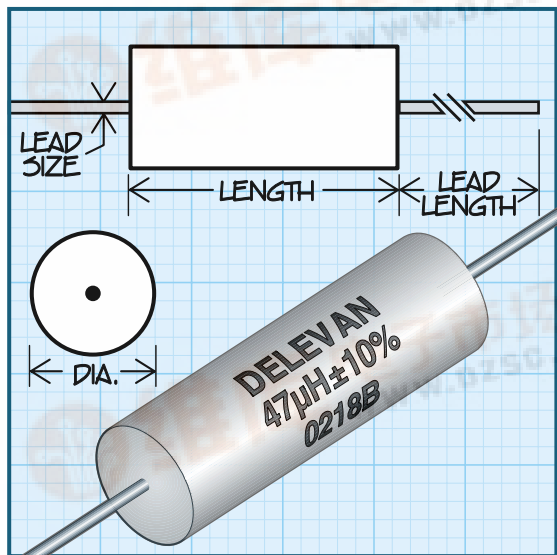

Military Specifications

MS91189 (LT4K); MS75103(LT10K)

Physical Parameters

	Inches	Millimeters
Length	0.900 ± 0.010	22.86 ± 0.25
Diameter	0.280 ± 0.010	7.11 ± 0.25
Lead Size		
AWG #21 TCW	0.028 ± 0.002	0.711 ± 0.051
Lead Length	1.44 ± 0.12	36.58 ± 3.05

Current Rating at 90°C Ambient

LT4K 35°C Rise
 LT10K 15°C Rise

Operating Temperature Range

LT4K -55°C to +125°C
 LT10K -55°C to +105°C

Maximum Power Dissipation at 90°C

LT4K 0.598 W
 LT10K 0.256 W

Weight Max. (Grams) 3.9

Packaging Tape & reel: 12" reel, 800 pieces max.;
 14" reel, 1300 pieces max. For additional packaging options, see technical section.

Made in the U.S.A.

DASH NUMBER*	MIL DASH #	INDUCTANCE (µH) ±10%	Q MINIMUM	TEST FREQUENCY (MHz)	SRF MINIMUM (MHz)	DC RESISTANCE MAXIMUM (OHMS)	CURRENT RATING MAXIMUM (mA)
MS91189- SERIES 2890 PHENOLIC CORE (LT4K)							
-00K	14	1.2	60	7.9	170	0.075	2400
-02K	15	1.5	60	7.9	160	0.090	2190
-03K	16	1.8	60	7.9	140	0.135	1790
-04K	17	2.2	60	7.9	125	0.160	1640
-06K	18	2.7	60	7.9	115	0.220	1400
-08K	19	3.3	60	7.9	100	0.305	1190
-10K	20	3.9	60	7.9	95	0.450	980
-12K	21	4.7	60	7.9	90	0.560	880
-14K	22	5.6	60	7.9	80	0.745	760
-16K	23	6.8	60	7.9	75	1.05	640
-18K	24	8.2	60	7.9	68	1.40	555
-20K	25	10.0	60	7.9	60	1.90	475
-22K	26	12.0	40	2.5	53	2.65	405
-24K	27	15.0	40	2.5	50	3.25	365
-26K	28	18.0	40	2.5	45	4.15	320
MS75103- SERIES 2890 IRON CORE (LT10K)							
-28K	1	22.0	50	2.5	24	0.295	815
-30K	2	27.0	45	2.5	22	0.35	750
-32K	3	33.0	60	2.5	19	0.55	595
-34K	4	39.0	55	2.5	18	0.65	550
-36K	5	47.0	65	2.5	16	1.00	445
-38K	6	56.0	65	2.5	14	1.15	410
-39K	7	68.0	75	2.5	13	1.85	325
-40K	8	82.0	75	2.5	12	2.10	305
-42K	9	100.0	75	2.5	12	2.50	279
-44K	10	120.0	95	0.79	10	4.10	219

Parts listed above are QPL/MIL qualified

Optional Tolerances: J = 5% H = 3% G = 2% F = 1%

*Complete part # must include series # PLUS the dash #

For further surface finish information, refer to TECHNICAL section of this catalog.

