



August 1999
Revised October 1999

74ACT16540

16-Bit Inverting Buffer/Line Driver with 3-STATE Outputs

General Description

The ACT16540 contains sixteen inverting buffers with 3-STATE outputs designed to be employed as a memory and address driver, clock driver, or bus-oriented transmitter/receiver. The device is byte controlled. Each byte has separate 3-STATE control inputs which can be shorted together for full 16-bit operation.

Features

- Separate control logic for each byte
- Outputs source/sink 24 mA
- TTL-compatible inputs

Ordering Code:

Order Number	Package Number	Package Description
74ACT16540SSC	MS48A	48-Lead Small Shrink Outline Package (SSOP), JEDEC MO-118, 0.300" Wide
74ACT16540MTD	MTD48	48-Lead Thin Shrink Small Outline Package (TSSOP), JEDEC MO-153, 6.1mm Wide

Device also available in Tape and Reel Specify by appending suffix letter "X" to the ordering code.

Logic Symbol

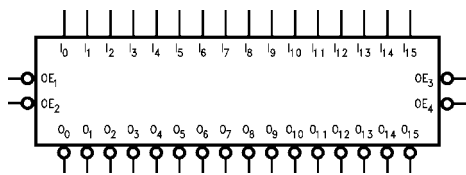

Connection Diagram

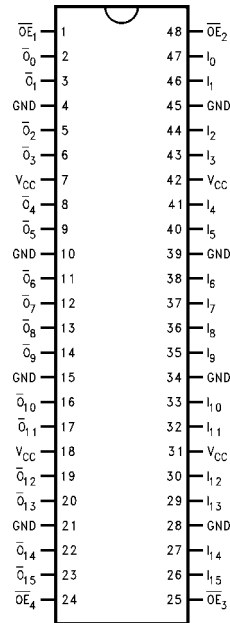

Pin Descriptions

Pin Names	Description
\overline{OE}_n	Output Enable Input (Active LOW)
I_0-I_{15}	Inputs
$\overline{O}_0-\overline{O}_{15}$	Outputs

FACT™ is a trademark of Fairchild Semiconductor Corporation.

74ACT16540 16-Bit Inverting Buffer/Line Driver with 3-STATE Outputs

74ACT16540

Functional Description

The ACT16540 contains sixteen inverting buffers with 3-STATE standard outputs. The device is byte controlled with each byte functioning identically, but independent of the other. The control pins may be shorted together to obtain full 16-bit operation. The 3-STATE outputs are controlled by an Output Enable (\overline{OE}_n) input for each byte. When \overline{OE}_n is LOW, the outputs are in 2-state mode. When \overline{OE}_n is HIGH, the outputs are in the high impedance mode, but this does not interfere with entering new data into the inputs.

Truth Tables

Inputs			Outputs
\overline{OE}_1	\overline{OE}_2	I_0-I_7	$\overline{O}_0-\overline{O}_7$
L	L	H	L
H	X	X	Z
X	H	X	Z
L	L	L	H

Inputs			Outputs
\overline{OE}_3	\overline{OE}_4	I_8-I_{15}	$\overline{O}_8-\overline{O}_{15}$
L	L	H	L
H	X	X	Z
X	H	X	Z
L	L	L	H

H = HIGH Voltage Level
 L = LOW Voltage Level
 X = Immaterial
 Z = High Impedance

Logic Diagram

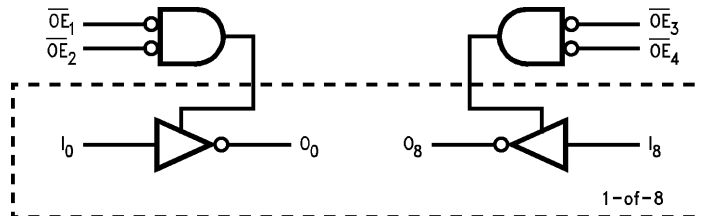

Absolute Maximum Ratings ^(Note 1)		Recommended Operating Conditions	
Supply Voltage (V_{CC})	-0.5V to +7.0V	Supply Voltage (V_{CC})	4.5V to 5.5V
DC Input Diode Current (I_{IK})		Input Voltage (V_I)	0V to V_{CC}
$V_I = -0.5V$	-20 mA	Output Voltage (V_O)	0V to V_{CC}
$V_I = V_{CC} + 0.5V$	+20 mA	Operating Temperature (T_A)	-40°C to +85°C
DC Output Diode Current (I_{OK})		Minimum Input Edge Rate ($\Delta V/\Delta t$)	125 mV/ns
$V_O = -0.5V$	-20 mA	V_{IN} from 0.8V to 2.0V	
$V_O = V_{CC} + 0.5V$	+20 mA	V_{CC} @ 4.5V, 5.5V	
DC Output Voltage (V_O)	-0.5V to $V_{CC} + 0.5V$	Note 1: Absolute maximum ratings are those values beyond which damage to the device may occur. The databook specifications should be met, without exception to ensure that the system design is reliable over its power supply, temperature, and output/input loading variables. Fairchild does not recommend operation of FACT™ circuits outside databook specifications.	
DC Output Source/Sink Current (I_O)	± 50 mA		
DC V_{CC} or Ground Current per Output Pin	± 50 mA		
Storage Temperature	-65°C to +150°C		

DC Electrical Characteristics								
Symbol	Parameter	V_{CC} (V)	$T_A = +25^\circ C$		$T_A = -40^\circ C$ to $+85^\circ C$		Units	Conditions
			Typ	Guaranteed Limits				
V_{IH}	Minimum HIGH Input Voltage	4.5	1.5	2.0	2.0	V	$V_{OUT} = 0.1V$ or $V_{CC} - 0.1V$	
		5.5	1.5	2.0	2.0			
V_{IL}	Maximum LOW Input Voltage	4.5	1.5	0.8	0.8	V	$V_{OUT} = 0.1V$ or $V_{CC} - 0.1V$	
		5.5	1.5	0.8	0.8			
V_{OH}	Minimum HIGH Output Voltage	4.5	4.49	4.4	4.4	V	$I_{OUT} = -50 \mu A$	
		5.5	5.49	5.4	5.4			
		4.5		3.86	3.76	V	$V_{IN} = V_{IL}$ or V_{IH} $I_{OH} = -24 mA$	
		5.5		4.86	4.76		$I_{OH} = -24 mA$ (Note 2)	
V_{OL}	Maximum LOW Output Voltage	4.5	0.001	0.1	0.1	V	$I_{OUT} = 50 \mu A$	
		5.5	0.001	0.1	0.1			
		4.5		0.36	0.44	V	$V_{IN} = V_{IL}$ or V_{IH} $I_{OL} = 24 mA$ $I_{OL} = 24 mA$ (Note 2)	
		5.5		0.36	0.44			
I_{OZ}	Maximum 3-STATE Leakage Current	5.5		± 0.5	± 5.0	μA	$V_I = V_{IL}, V_{IH}$ $V_O = V_{CC}, GND$	
I_{IN}	Maximum Input Leakage Current	5.5		± 0.1	± 1.0	μA	$V_I = V_{CC}, GND$	
I_{CCT}	Maximum $I_{CC}/Input$	5.5	0.6		1.5	mA	$V_I = V_{CC} - 2.1V$	
I_{CC}	Max Quiescent Supply Current	5.5		8.0	80.0	μA	$V_{IN} = V_{CC}$ or GND	
I_{OLD}	Minimum Dynamic Output Current (Note 3)	5.5			75	mA	$V_{OLD} = 1.65V$ Max	
I_{OHD}	Output Current (Note 3)				-75	mA	$V_{OHD} = 3.85V$ Min	

Note 2: All outputs loaded; thresholds associated with output under test.

Note 3: Maximum test duration 2.0 ms; one output loaded at a time.

74ACT16540

AC Electrical Characteristics								
Symbol	Parameter	V _{CC} (V) (Note 4)	T _A = +25°C C _L = 50 pF			T _A = -40°C to +85°C C _L = 50 pF		Units
			Min	Typ	Max	Min	Max	
t _{PLH}	Propagation Delay	5.0	2.7	4.9	7.3	2.7	7.8	ns
t _{PHL}	Data to Output		3.0	5.1	7.3	3.0	7.8	
t _{PZH}	Output Enable	5.0	2.5	4.8	7.4	2.5	7.9	ns
t _{PZL}	Time		2.7	5.3	8.0	2.7	8.5	
t _{PHZ}	Output Disable	5.0	2.5	5.4	8.3	2.5	8.7	ns
t _{PLZ}	Time		2.3	5.0	7.4	2.3	7.9	

Note 4: Voltage Range 5.0 is 5.0V ± 0.5V.

Capacitance				
Symbol	Parameter	Typ	Units	Conditions
C _{IN}	Input Pin Capacitance	4.5	pF	V _{CC} = 5.0V
C _{PD}	Power Dissipation Capacitance	30	pF	V _{CC} = 5.0V

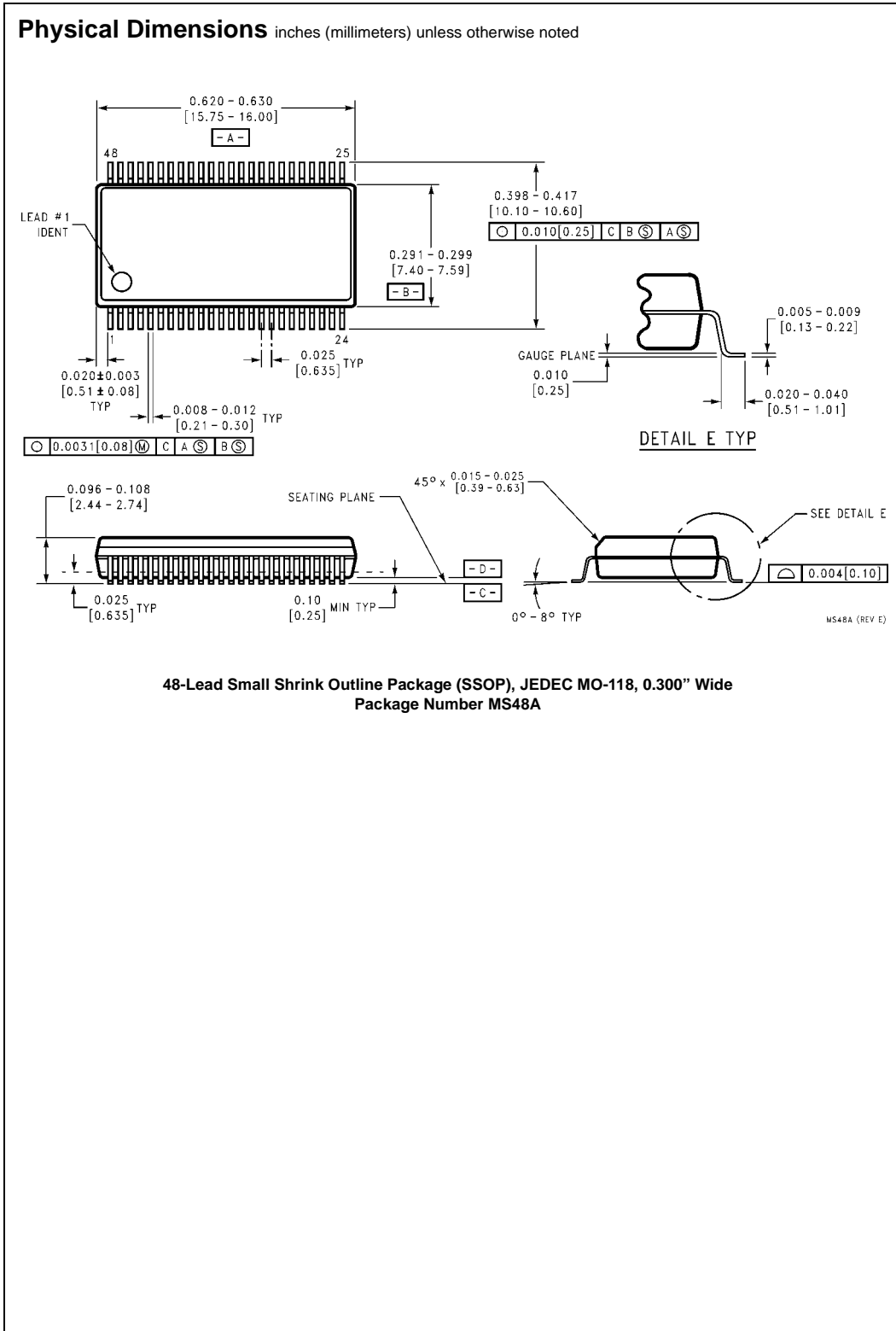

74ACT16540

Physical Dimensions inches (millimeters) unless otherwise noted (Continued)

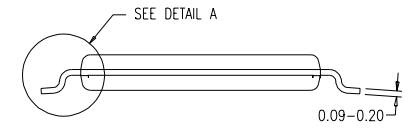
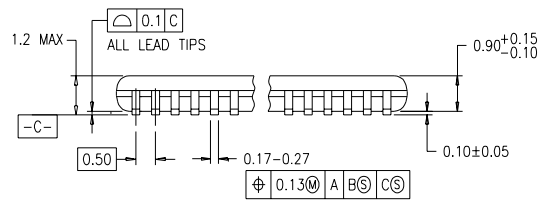
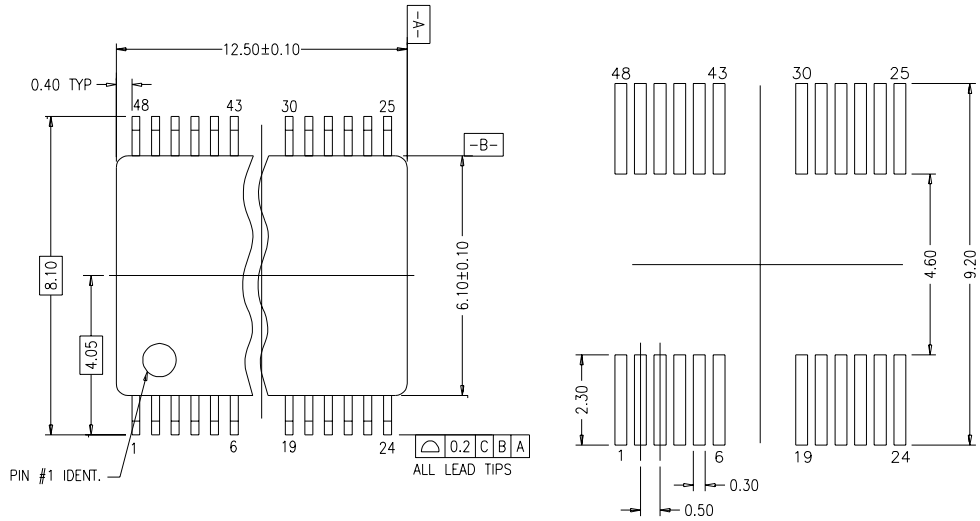

DIMENSIONS ARE IN MILLIMETERS

NOTES:

- A. CONFORMS TO JEDEC REGISTRATION MO-153, VARIATION AB, REF NOTE 6, DATE 7/93.
- B. DIMENSIONS ARE IN MILLIMETERS.
- C. DIMENSIONS ARE EXCLUSIVE OF BURRS, MOLD FLASH, AND TIE BAR EXTRUSIONS.
- D. DIMENSIONS AND TOLERANCES PER ANSI Y14.5M, 1982.

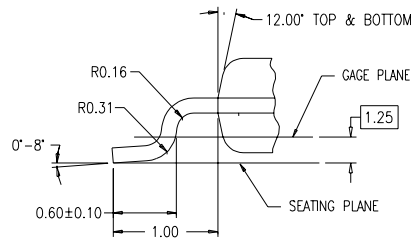

DETAIL A

MTD48REVB1

48-Lead Thin Shrink Small Outline Package (TSSOP), JEDEC MO-153, 6.1mm Wide Package Number MTD48

Fairchild does not assume any responsibility for use of any circuitry described, no circuit patent licenses are implied and Fairchild reserves the right at any time without notice to change said circuitry and specifications.

LIFE SUPPORT POLICY

FAIRCHILD'S PRODUCTS ARE NOT AUTHORIZED FOR USE AS CRITICAL COMPONENTS IN LIFE SUPPORT DEVICES OR SYSTEMS WITHOUT THE EXPRESS WRITTEN APPROVAL OF THE PRESIDENT OF FAIRCHILD SEMICONDUCTOR CORPORATION. As used herein:

1. Life support devices or systems are devices or systems which, (a) are intended for surgical implant into the body, or (b) support or sustain life, and (c) whose failure to perform when properly used in accordance with instructions for use provided in the labeling, can be reasonably expected to result in a significant injury to the user.
2. A critical component in any component of a life support device or system whose failure to perform can be reasonably expected to cause the failure of the life support device or system, or to affect its safety or effectiveness.

www.fairchildsemi.com