

- Completely independent QT touch circuits
- Individual logic outputs per channel (open drain)
- Projects prox fields through any dielectric
- Only one external capacitor required per channel
- Sensitivity easily adjusted on a per-channel basis
- 100% autocal for life - no adjustments required
- 3~5.5V, 5mA single supply operation
- Toggle mode for on/off control (strap option)
- 10s, 60s, infinite auto-recal timeout (strap options)
- AKS™ Adjacent Key Suppression (pin option)
- Sync pin for multi-chip sync or line sync
- Less expensive per key than many mechanical switches
- Eval board with backlighting - p/n E160

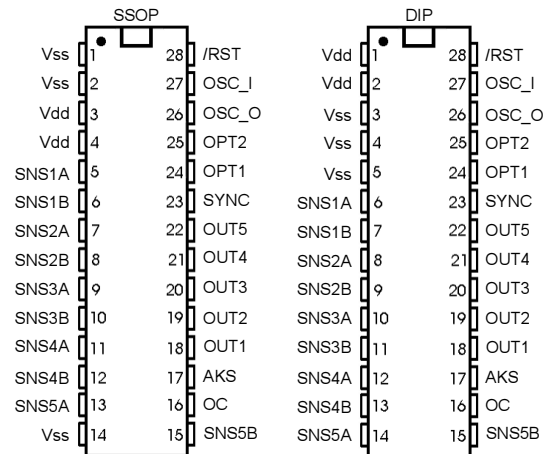

QT150 shown - NOTE: Pinouts are not the same!

APPLICATIONS

- ◆ PC Peripherals
- ◆ Backlighted buttons
- ◆ Appliance controls
- ◆ Security systems
- ◆ Access systems
- ◆ Pointing devices
- ◆ Instrument panels
- ◆ Gaming machines

QT140 / QT150 charge-transfer ("QT") QTouch ICs are self-contained digital controllers capable of detecting near-proximity or touch on 4 or 5 electrodes. They allow electrodes to project independent sense fields through any dielectric like glass, plastic, stone, ceramic, and wood. They can also turn metal-bearing objects into intrinsic sensors, making them responsive to proximity or touch. This capability coupled with their continuous self-calibration feature can lead to entirely new product concepts, adding high value to product designs.

Each of the channels operates independently of the others, and each can be tuned for a unique sensitivity level by simply changing its sample capacitor value.

The devices are designed specifically for human interfaces, like control panels, appliances, gaming devices, lighting controls, or anywhere a mechanical switch or button may be found; they may also be used for some material sensing and control applications.

These devices require only a common inexpensive capacitor per sensing channel in order to function. They also offer patent pending AKS™ Adjacent Key Suppression which suppresses touch from weaker responding keys and allows only a dominant key to detect, for example to solve the problem of large fingers on tightly spaced keys.

These devices also have a SYNC I/O pin which allows for synchronization with additional similar parts and/or to an external to suppress interference.

The RISC core of these devices use signal processing techniques pioneered by Quantum which are designed to survive numerous real-world challenges, such as 'stuck sensor' conditions, component ageing, moisture films, and signal drift.

By using the charge transfer principle, these devices deliver a level of performance clearly superior to older technologies yet are highly cost-effective.

AVAILABLE OPTIONS

T _A	SSOP-28	DIP-28
0°C to +70°C	-	QT140-D
-40°C to +105°C	QT140-AS	-
0°C to +70°C	-	QT150-D
-40°C to +105°C	QT150-AS	-

Table 1-1 Pin Listing

QT140 / QT150 SSOP-28			QT140 / QT150 DIP-28		
Pin	Name	Description	Pin	Name	Description
1	Vss	Negative power (Ground)	1	Vdd	Positive power
2	Vss	Negative power (Ground)	2	Vdd	Positive power
3	Vdd	Positive power	3	Vss	Negative power (Ground)
4	Vdd	Positive power	4	Vss	Negative power (Ground)
5	SNS1A	Sense pin (to Cs1, electrode)	5	Vss	Negative power (Ground)
6	SNS1B	Sense pin (to Cs1)	6	SNS1A	Sense pin (to Cs1, electrode)
7	SNS2A	Sense pin (to Cs2, electrode)	7	SNS1B	Sense pin (to Cs1)
8	SNS2B	Sense pin (to Cs2)	8	SNS2A	Sense pin (to Cs2, electrode)
9	SNS3A	Sense pin (to Cs3, electrode)	9	SNS2B	Sense pin (to Cs2)
10	SNS3B	Sense pin (to Cs3)	10	SNS3A	Sense pin (to Cs3, electrode)
11	SNS4A	Sense pin (to Cs4, electrode)	11	SNS3B	Sense pin (to Cs3)
12	SNS4B	Sense pin (to Cs4)	12	SNS4A	Sense pin (to Cs4, electrode)
13	NC/SNS5A	Sense pin (to Cs5, electrode) n/c on QT140	13	SNS4B	Sense pin (to Cs4)
14	Vss	Supply negative rail (ground)	14	NC/SNS5A	Sense pin (to Cs5, electrode) n/c on QT140
15	NC/SNS5B	Sense pin (to Cs5) n/c on QT140	15	NC/SNS5B	Sense pin (to Cs5) n/c on QT140
16	OC	Output Option (input pin; 1= open drain)	16	OC	Output Option (input pin; 1= open drain)
17	AKS	Adjacent Key Suppression Opt. (input; 1=AKS)	17	AKS	Adjacent Key Suppression Opt. (input ; 1=AKS)
18	OUT1	Channel 1 output, o-d or p-p	18	OUT1	Channel 1 output, o-d or p-p
19	OUT2	Channel 2 output, o-d or p-p	19	OUT2	Channel 2 output, o-d or p-p
20	OUT3	Channel 3 output, o-d or p-p	20	OUT3	Channel 3 output, o-d or p-p
21	OUT4	Channel 4 output, o-d or p-p	21	OUT4	Channel 4 output, o-d or p-p
22	NC/OUT5	Channel 5 output, o-d or p-p (n/c on QT140)	22	NC/OUT5	Channel 5 output, o-d or p-p (n/c on QT140)
23	SYNC	Synchronization pin (I/O pin - pull high with 10K)	23	SYNC	Synchronization pin (I/O pin - pull high with 10K)
24	OPT1	Option Mode (Input pin - see Table 2-1)	24	OPT1	Option Mode (Input pin - see Table 2-1)
25	OPT2	Option Mode (Input pin - see Table 2-1)	25	OPT2	Option Mode (Input pin - see Table 2-1)
26	OSC_O	Oscillator output	26	OSC_O	Oscillator output
27	OSC_I	Oscillator input	27	OSC_I	Oscillator input
28	/RST	Reset pin (active low input)	28	/RST	Reset pin (active low input)

1 - OVERVIEW

QT140/150 devices are burst mode digital charge-transfer (QT) sensor ICs designed specifically for touch controls; they include all hardware and signal processing functions necessary to provide stable sensing under a wide variety of conditions. Only a single low cost capacitor per channel is required for operation.

Figures 1-6 and 1-7 show basic circuits for these devices. See Table 1-1 for device pin listings.

The DIP and SOIC pinouts are not the same and serious damage can occur if a part is miswired.

1.1 BASIC OPERATION

The devices employ bursts of charge-transfer cycles to acquire signals. Burst mode permits low power operation, dramatically reduces RF emissions, lowers susceptibility to RF fields, and yet permits excellent speed. Internally, signals are digitally processed to reject impulse noise using a 'consensus' filter that requires three consecutive confirmations of detection. Each channel is measured in sequence starting with Channel 1.

The QT switches and charge measurement hardware functions are all internal to the device. A single-slope switched capacitor ADC includes the QT charge and transfer switches in a configuration that provides direct ADC conversion; an external Cs capacitor accumulates the charge from sense-plate Cx, which is then measured.

Larger values of Cx cause the charge transferred into Cs to rise more rapidly, reducing available resolution; as a minimum resolution is required for proper operation, this can result in dramatically reduced gain. Conversely, larger values of Cs reduce the rise of differential voltage across it, increasing available resolution by permitting longer QT bursts. The value of Cs can thus be increased to allow larger values of Cx to be tolerated. The IC is responsive to both Cx and Cs, and changes in Cs can result in substantial changes in sensor gain.

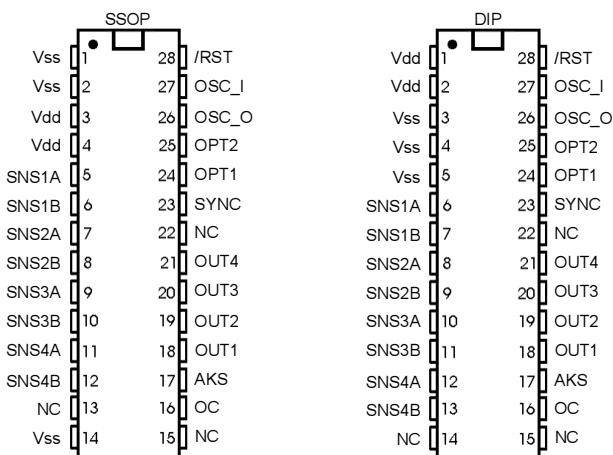

Fig 1-1 QT140 Pinouts
NOTE: SSOP / DIP Pinouts are not the same!

Unused channels: If a channel is not used, a dummy sense capacitor (Optima) (F) of any type must be connected between the unused SNSnA / SNSnB pins ensure correct operation.

Unused pins: Unused device pins labeled NC should remain unconnected.

1.2 ELECTRODE DRIVE

These devices have completely independent sensing channels. The internal ADC treats Cs on each channel as a floating transfer capacitor; as a direct result, sense electrodes can be connected to either SNSnA or SNSnB and the sensitivity and basic function will be the same; however there is an advantage in connecting electrodes to SNSnA lines to reduce EMI susceptibility.

The PCB traces, wiring, and any components associated with or in contact with SNSnA and SNSnB will become touch sensitive and should be treated with caution to limit the touch area to the desired location.

Multiple touch electrodes connected to SNSnA can be used, for example to create control surfaces on both sides of an object.

It is important to limit the amount of stray capacitance on the SNSnA and SNSnB terminals, for example by minimizing trace lengths and widths to allow for higher gains and lower values of Cs.

1.3 KEY DESIGN

1.3.1 KIRCHOFF'S CURRENT LAW

Like all capacitance sensors, these parts rely on Kirchoff's Current Law (Figure 1-2) to detect the change in capacitance of the electrode. This law as applied to capacitive sensing requires that the sensor's field current must complete a loop, returning back to its source in order for capacitance to be sensed. Although most designers relate to Kirchoff's law with regard to hardwired circuits, it applies equally to capacitive field flows. By implication it requires that the signal ground and the target object must both be coupled together in some manner for a capacitive sensor to operate properly. Note that there is no need to provide actual galvanic ground connections; capacitive coupling to ground (Cx1) is always

sufficient, even if the coupling might seem very tenuous. For example, powering the sensor via an isolated transformer will provide ample ground coupling, since there is capacitance between the windings and/or the transformer core, and from the power wiring itself directly to 'local earth'. Even when battery powered, just the physical size of the PCB and the object into which the electronics is embedded will generally be enough to couple a few picofarads back to local earth.

1.3.2 KEY GEOMETRY, SIZE, AND LOCATION

There is no restriction on the shape of the key electrode; in most cases common sense and a little experimentation can result in a good electrode design. The devices will operate with long thin electrodes, round or square ones, or keys with odd shapes. Electrodes can also be on 3-dimensional surfaces. Sensitivity is related to the amount of electrode surface area, overlying panel material and thickness, and the ground return coupling quality of the circuit.

If a relatively large touch area is desired, and if tests show that the electrode has more capacitance than the part can tolerate, the electrode can be made into a sparse mesh (Figure 1-3) having lower Cx than a solid plane.

Since the channels acquire their signals in time-sequence, any of the electrodes can be placed in direct proximity to each other if desired without cross-interference.

1.3.3 BACKLIGHTING KEYS

Touch pads can be back-illuminated quite readily using electrodes with a sparse mesh (Figure 1-3) or a hole in the middle (Figure 1-4). The holes can be as large as 4 cm in diameter provided that the ring of metal is at least twice as wide as the thickness of the overlying panel, and the panel is greater than 1/8 as thick as the diameter of the hole. Thin panels do not work well with this method as they do not propagate fields laterally very well, and will have poor sensitivity in the middle. Experimentation is required.

A good example of backlighting can be found in the E160 evaluation board.

1.3.4 VIRTUAL CAPACITIVE GROUNDS

When detecting human contact (e.g. a fingertip), grounding of the person is never required. The human body naturally has several hundred picofarads of 'free space' capacitance to the local environment (Cx3 in Figure 1-2), which is more than two orders of magnitude greater than that required to create a detection. The sensor's PCB however may be physically small, so there may be little 'free space' coupling (Cx1 in Figure 1-2) between it and the environment to

Figure 1-2 Kirchoff's Current Law

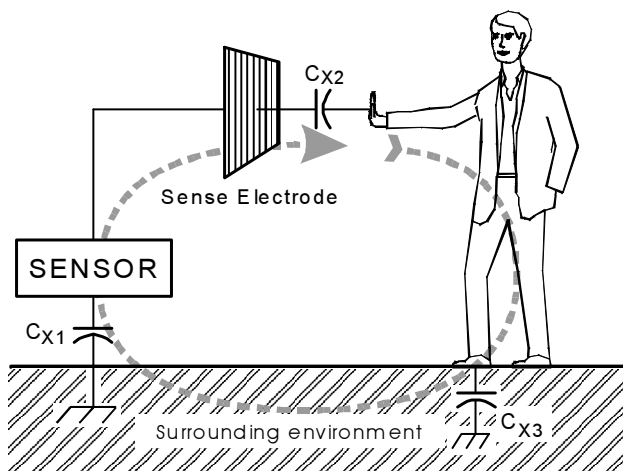

Figure 1-3 Mesh Electrode Geometry

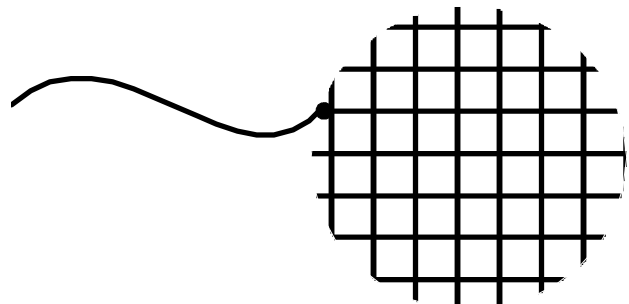
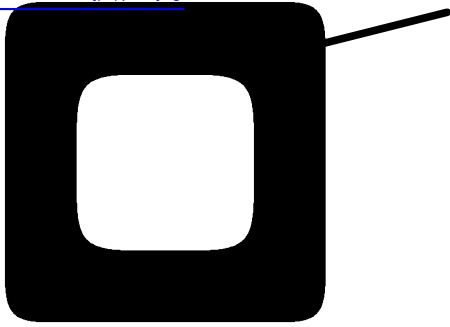

Figure 1-4 Open Electrode for Back-Illumination
[查询"QT140"供应商](#)



complete the return path. If the circuit ground cannot be earth grounded by wire, for example via the supply connections, then a 'virtual capacitive ground' may be required to increase return coupling.

A 'virtual capacitive ground' can be created by connecting the IC's circuit ground to:

- (1) A nearby piece of metal or metallized housing;
- (2) A floating conductive ground plane;
- (3) A larger electronic device (to which its output might be connected anyway).

Free-floating ground planes such as metal foils should maximize exposed surface area in a flat plane if possible. A square of metal foil will have little effect if it is rolled up or crumpled into a ball. Virtual ground planes are more effective and can be made smaller if they are physically bonded to other surfaces, for example a wall or floor.

1.3.5 FIELD SHAPING

The electrode can be prevented from sensing in undesired directions with the assistance of metal shielding connected to circuit ground (Figure 1-5). For example, on flat surfaces, the field can spread laterally and create a larger touch area than desired. To stop field spreading, it is only necessary to surround the touch electrode on all sides with a ring of metal connected to circuit ground. The ring will stop field spreading from that point outwards.

If one side of the panel to which the electrode is fixed has moving traffic near it, these objects can cause inadvertent detections. This is called 'walk-by' and is caused by the fact that the fields radiate from either surface of the electrode equally well. Again, shielding in the form of a metal sheet or foil connected to circuit ground will prevent walk-by; putting an air gap between the grounded shield and the electrode will help to keep the value of C_x low.

1.3.6 SENSITIVITY

Sensitivity can be altered to suit various applications and situations on a channel-by-channel basis. The easiest and

Figure 1-5 Shielding Against Fringe Fields

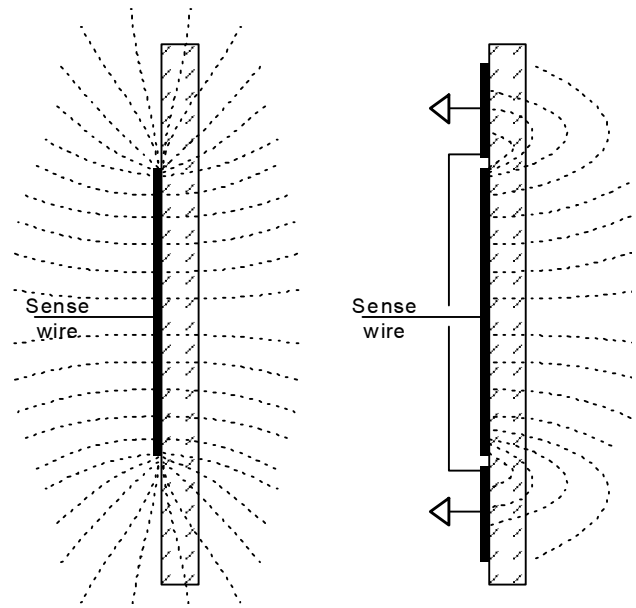

most direct way to impact sensitivity is to alter the value of C_s ; more C_s yields higher sensitivity.

1.3.6.1 Alternative Ways to Increase Sensitivity

Sensitivity can also be increased by using bigger electrodes, reducing panel thickness, or altering panel composition.

Increasing electrode size can have diminishing returns, as high values of C_x counteract sensor gain; however, C_s can be increased to combat this up to the rated device limit. Also, increasing the electrode's surface area will not substantially increase touch sensitivity if its diameter is already much larger in surface area than fingertip contact area.

The panel or other intervening material can be made thinner, but again there are diminishing rewards for doing so. Panel material can also be changed to one having a higher dielectric constant, which will help propagate the field through to the front. Locally adding some conductive material to the panel (conductive materials essentially have an infinite dielectric constant) will also help; for example, adding carbon or metal fibers to a plastic panel will greatly increase frontal field strength, even if the fiber density is too low to make the plastic bulk-conductive.

1.3.6.2 Decreasing Sensitivity

In some cases the circuit may be too sensitive. Gain can be lowered further by a number of strategies: a) making the electrode smaller, b) making the electrode into a sparse mesh using a high space-to-conductor ratio (Figure 1-3), or c) by decreasing the C_s capacitors.

2 - QT140/QT150 SPECIFICS

查询"QT140"供应商

2.1 SIGNAL PROCESSING

These devices process all signals using 16 bit math, using a number of algorithms pioneered by Quantum. These algorithms are specifically designed to provide for high survivability in the face of adverse environmental changes.

2.1.1 DRIFT COMPENSATION

Signal drift can occur because of changes in Cx, Cs, and Vdd over time. If a low grade Cs capacitor is chosen, the signal can drift greatly with temperature. If keys are subject to extremes of temperature or humidity, the signal can also drift. It is crucial that drift be compensated, else false detections, non-detections, and sensitivity shifts will follow.

Drift compensation (Figure 2-1) is a method that makes the reference level track the raw signal at a slow rate, only while no detection is in effect. The rate of reference adjustment must be performed slowly else legitimate detections can also be ignored. The IC drift compensates each channel independently using a slew-rate limited change to the reference level; the threshold and hysteresis values are slaved to this reference.

Once an object is sensed, the drift compensation mechanism ceases since the signal is legitimately high, and therefore should not cause the reference level to change.

The signal drift compensation is 'asymmetric'; the reference level drift-compensates in one direction faster than it does in the other. Specifically, it compensates faster for decreasing signals than for increasing signals. Increasing signals should not be compensated for quickly, since an approaching finger could be compensated for partially or entirely before even approaching the sense electrode. However, an obstruction over the sense pad, for which the sensor has already made full allowance for, could suddenly be removed leaving the sensor with an artificially elevated reference level and thus become insensitive to touch. In this latter case, the sensor will compensate for the object's removal very quickly, usually in only a few seconds.

With large values of Cs and small values of Cx, drift compensation will appear to operate more slowly than with the converse.

2.1.2 THRESHOLD CALCULATION

The internal threshold level is fixed at 6 counts for all channels. These IC's employ a fixed hysteresis of 2 counts below the threshold (33%).

2.1.3 MAX ON-DURATION

If a sufficiently large object contacts a key for a prolonged duration, the signal will trigger a detection output preventing further normal operation. To cure such 'stuck key' conditions, the sensor includes a timer on each channel to monitor detection duration. If a detection exceeds the maximum timer setting, the timer causes the sensor to perform a full recalibration (if not set for infinite). This is known as the Max On-Duration feature.

After the Max On-Duration interval, the sensor channel will once again function normally, even if partially or fully obstructed, to the best of its ability given electrode

Figure 2-1 Drift Compensation

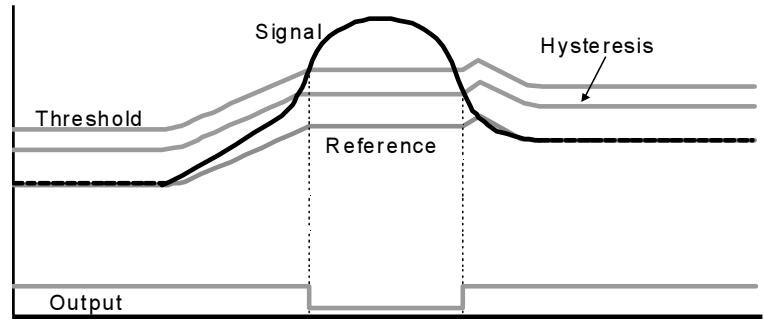

conditions. There are three timeout durations available via strap option: 10s, 60s, and infinite (Table 2-1).

Max On-Duration works independently per channel; a timeout on one channel has no effect on another channel except when the AKS feature is impacted on an adjacent key. Note also that the timings in Table 2-1 are dependent on the oscillator frequency: Doubling the recommended frequency will halve the timeouts.

Infinite timeout is useful in applications where a prolonged detection can occur and where the output must reflect the detection no matter how long. In infinite timeout mode, the designer should take care to be sure that drift in Cs, Cx, and Vdd do not cause the device to 'stick on' inadvertently even when the target object is removed from the sense field.

The delay timings for Max On-Duration depend directly on resonator frequency. Also, if the acquisition burst on one or more channels lasts longer than 5.5ms per channel, the specified timings may be longer.

2.1.4 DETECTION INTEGRATOR

It is desirable to suppress false detections due to electrical noise or from quick brushes with an object. To this end, these devices incorporate a per-key 'Detection Integrator' counter that increments with each signal detection exceeding the signal threshold (Figure 2-1) until a limit count is reached, after which an Out pin becomes active. If a 'no detect' is sensed prior to the limit, this counter is reset to zero. The required limit count is 3.

The Detection Integrator can also be viewed as a 'consensus' vote requiring a detection in three successive samples to trigger an active output.

2.1.5 FORCED SENSOR RECALIBRATION

Pin 28 is a Reset pin, active-low, which in cases where power is clean can be simply tied to Vdd. On power-up, the device will automatically recalibrate all channels of sensing.

Pin 28 can also be controlled by logic or a microcontroller to force the chip to recalibrate, by toggling it low for 5 μ s then raising it high again.

2.1.6 RESPONSE TIME

Response time is fixed at 99ms at a 10MHz clock. Response time can be altered by changing the clock frequency; doubling the frequency to 20MHz will cut the response time to 49ms.

2.2 OUTPUT FEATURES

The devices are designed for maximum flexibility and can accommodate most popular sensing requirements via option pins.

OPT1 and **OPT2** inputs control the output mode and Max On-Duration settings;

OC controls the output drive type;

AKS controls the use of Adjacent Key Suppression.

All option pins are read by the IC once each complete acquisition cycle and can be changed during operation.

OPT1 and OPT2 modes are shown in Table 2-1. These OPT pins affect all sensing channels.

2.2.1 DC MODE OUTPUTS

Outputs can respond in a DC mode, where they are active upon a confirmed detection. An output will remain active for the duration of the detection, or until the 'Max On-Duration' expires (if not infinite), whichever occurs first. If a Max On-Duration timeout occurs first, the sensor performs a full recalibration and the output becomes inactive until the next detection.

2.2.2 TOGGLE MODE OUTPUTS

This mode makes the sensor respond in an on/off flip-flop mode. It is useful for controlling power loads, for example in kitchen appliances, power tools, light switches, etc. or wherever a 'touch-on / touch-off' effect is required.

Max On-Duration in Toggle mode is fixed at 10 seconds. When a timeout occurs, the sensor recalibrates but leaves the output state unchanged.

2.2.3 OUTPUT DRIVE; OC OPTION PIN

The OC pin controls the output drive type.

OC=0: When tied low, the output is 'push-pull', i.e. 'normal'. In this mode, the OUT pins are active-high and can source 1mA and sink 5mA of non-inductive current.

OC=1: When tied high, the output is 'open drain' or 'open collector', i.e. There is no internal pullup device in this mode; OUT pins are active-low and can sink 5mA of non-inductive current.

If inductive loads are used, such as small relays, the inductances should be diode clamped to prevent damage. When set to operate in a proximity mode (at high gain) output pin currents should be limited to 1mA to prevent gain shifting side effects from occurring, which happens when the load current creates voltage drops on the die and bonding wires; these small shifts can materially influence the signal level to cause detection instability as described below.

Care should be taken when the IC and the loads are both powered from the same supply, and the supply is minimally regulated. These devices derive their internal references from the power supply, and sensitivity shifts can occur with changes in Vdd, as happens when loads are switched on. This can induce detection 'cycling', whereby an object is detected, the load is turned on, the supply sags, the detection is no longer sensed, the load is turned off, the supply rises and the object is reacquired, *ad infinitum*. To prevent this occurrence, the Out pins should only be lightly loaded if the device is operated from an unregulated supply,

Table 2-1 OPT Strap Options

	OPT1	OPT2	Max On-Duration
DC Out	Gnd	Vdd	10s
DC Out	Vdd	Gnd	60s
Toggle	Vdd	Vdd	10s
DC Out	Gnd	Gnd	infinite

e.g. batteries. Detection 'stiction', the opposite effect, can occur if a load is *shed* when an Out pin is active.

2.3 AKS™ - ADJACENT KEY SUPPRESSION

These devices feature patent-pending Adjacent Key Suppression for use in applications where keys are tightly spaced. If keys are very close and a large finger touches one key, adjacent keys might also activate. AKS stops such false detections by comparing relative signal levels among channels and choosing the channel with the largest signal.

The AKS feature can be disabled via the AKS pin:

AKS=0: Disabled; **AKS=1:** Enabled

The AKS in these parts is a 'global' in nature, meaning that the signal of each key is compared with all other keys, and only the key with the strongest signal among all keys will survive initial detection. The word 'Adjacent' therefore should be taken liberally, as a particular key number can be physically near any other key number and the AKS feature will operate correctly.

When a touch is detected on a key, but just before the corresponding OUT pin is activated, a check is made for a pending or current detection on the other keys. If any other key is active, *or if a signal of greater strength is found on any other key*, the key detection is suppressed. Once the active key(s) are released, a pending key is free to detect.

Drift compensation also ceases for any key which has been suppressed, provided its signal exceeds its threshold level (Figure 2-1).

AKS is also very effective on water films which bridge over adjacent keys. When touching one key a water film will 'transport' the touch to the adjacent keys covered by the same film. These side keys will receive less signal strength than the key actually being touched, and so they will be suppressed even if the signal they are detecting is large enough to otherwise cause an output.

The downside of 'global' AKS is that it is not possible to have more than one key active at a time.

When two or more devices are synchronized together and all are using AKS mode, the AKS feature does not extend beyond each chip. Therefore, in multi-chip configurations it is possible to use AKS on all keys but still permit 2 or more keys to detect at the same time.

2.4 SYNCHRONIZATION

Adjacent capacitive sensors that operate independently can cross-interfere with each other in ways that will create sensitivity shifts and spurious detections. Because Quantum's QT devices operate in burst mode as opposed to continuous mode, the opportunity exists to solve this problem by using time-sequencing of the sensing channels so that physically adjacent channels do not sense within the same

time-slot. Within these ICs the sensing channels already operate in a sequence, so it is not possible for a given IC's channels to cross-interfere with each other even if the electrodes are directly adjacent to one another.

However the use of 2 or more chips can create a problem, because if they are not somehow synchronized to each other the cross-interference problem will occur between adjacent channels of the different chips.

2.4.1 MULTI-CHIP SYNC

A bidirectional, open-drain SYNC pin has been provided to allow 2 or more QT140's or QT150's in various combinations to synchronize to each other (Figure 1-8). All the chips in a system, whether 1 or 20, should connect to this common line with a single 10K pullup resistor.

A single QT140 or QT150 must also use a pullup resistor.

SYNC floats high during the Channel 1 sensing burst. When the IC completes Channel 1 sensing, it pulls down SYNC. SYNC will continue to be pulled low until the last sensing channel has completed, when it is unclamped. The IC waits until SYNC rises high before it will start Channel 1 sensing again.

If two or more chips are tied into SYNC, all chips must release SYNC before it actually floats high. Thus, all chips that use a common SYNC connection will synchronize on Channel 1.

This mechanism forces all like sensing channels to be time-aligned among all chips. Thus, all Channel 1's acquire at the same time, then all Channel 2's etc. This means that when designing a PCB and electrode array, it is important to not place like channel numbers next to each other or they will cross interfere. However this leaves a tremendous latitude for placing channels from different chips having different channel numbers next to each other.

For example Channel 1 of chip 'A' can be routed and physically placed adjacent to Channel 2 of chip 'B', or Channel 4 of chip 'F' and so on. But it is not good to place Channel 3 of chip 'A' next to Channel 3 of chip 'B'.

2.4.2 NOISE SYNC

The effects of external noise sources can be heavily suppressed by synchronizing these devices to the noise source itself. External noise creates an 'aliasing' or 'beat' frequency effect between the sampling rate of the QT part and the external noise frequency.

In many cases, especially with repetitive noise like 50/60Hz AC fields, the noise effects will vanish if the device is synchronized to the external field. This can take the form of a simple AC zero-crossing detector feeding the pullup resistor on SYNC instead of tying the SYNC resistor to Vdd. Multiple devices tied to SYNC can be synchronized to the mains frequency in this fashion.

In the case of noise from sources such as backlight inverters etc, it is sometimes best to synchronize by disabling the inverter for a brief moment while the QT device acquires.

3 - CIRCUIT GUIDELINES

3.1 SAMPLE CAPACITOR

Charge sampler caps Cs can be virtually any plastic film or low to medium-K ceramic capacitor. The acceptable Cs range is from 1nF to 200nF depending on the sensitivity required; larger values of Cs demand higher stability to ensure reliable sensing. Acceptable capacitor types include plastic film (especially PPS film), NP0 / C0G ceramic. X7R ceramic can also be used but these are less stable over temperature.

3.2 OPTION STRAPPING

The option pins OC, AKS, OPT1 and OPT2 should never be left floating. If they are floated, the device can draw excess power and the options will not be properly read. See Section 2.2 and 2.3 for options.

3.3 POWER SUPPLY, PCB LAYOUT

The power supply can range from 3 to 5.5 volts. If this fluctuates slowly with temperature, the device will track and compensate for these changes automatically with only minor changes in sensitivity. If the supply voltage drifts or shifts quickly, the drift compensation mechanism will not be able to keep up, causing sensitivity anomalies or false detections. The devices will track slow changes in Vdd, but can be seriously affected by rapid voltage steps.

If the supply is shared with another electronic system, care should be taken to assure that the supply is free of digital spikes, sags, and surges which can cause adverse effects.

The supply is best locally regulated using a conventional 78L05 type regulator, or almost any 3-terminal LDO device from 3V to 5V.

For proper operation a 0.1μF or greater bypass capacitor must be used between Vdd and Vss; the bypass cap should be placed very close to the device Vss and Vdd pins.

The PCB should if possible include a copper pour under and around the IC, but not extensively under the SNS lines.

3.4 OSCILLATOR

The oscillator should be a 10MHz resonator with ceramic capacitors to ground on each side. 3-pin resonators with built-in capacitors designed for the purpose are inexpensive and commonly found. Manufacturers include AVX, Murata, Panasonic, etc.

Alternatively an external clock source can be used in lieu of a resonator. The OSC_I pin should be connected to the external clock, and OSC_O should be left unconnected.

These ICs are fully synchronous devices that are slaved to the OSC_I clock frequency. If the frequency of OSC_I is changed, all timings will also change in direct proportion, from the charge and transfer times to the detection response times and the Max On-duration timings.

3.5 UNUSED CHANNELS

Unused SNS pins should not be left open. They should have a small value non-critical dummy Cs capacitor connected to their SNS pins to allow the internal circuit to continue to function properly. A nominal value of 1nF (1,000pF) X7R ceramic will suffice.

Unused channels should not have sense traces or electrodes connected to them.

查询QT140供应商

3.6 ESD PROTECTION

In cases where the electrode is placed behind a dielectric panel, the IC will be protected from direct static discharge. However even with a panel, transients can still flow into the electrodes via induction, or in extreme cases via dielectric breakdown. Porous materials may allow a spark to tunnel right through the material. Testing is required to reveal any problems. The device does have diode protection on its SNS pins which absorb and protect the device from most induced discharges, up to 20mA; the usefulness of the internal clamping will depend on the dielectric properties, panel thickness, and rise time of the ESD transients.

In extreme cases ESD dissipation can be aided further by adding 1K series resistors in series with the electrodes as shown in Figures 1-6 through 1-8. Because the charge time is 1.2 μ s, the circuit can tolerate large values of series-R, up to 20k ohms in cases where electrode Cx load is below 10pF. Extra diode protection at the electrodes can also be used, but this often leads to additional RFI problems as the diodes will rectify RF signals into DC which will disturb the signals.

If the series-R is too large, sensitivity will drop off.

Directly placing semiconductor transient protection devices or MOV's on the sense leads is *not advised*; these devices have extremely large amounts of nonlinear parasitic C which will swamp the capacitance of the electrode and cause strange sensing problems.

Series-R's should be low enough to permit at least 6 RC time-constants to occur during the charge and transfer phases, where R is the added series-R and C is the load Cx.

If the device is connected to an external control circuit via a cable or long twisted pair, it is possible for ground-bounce to cause damage to the Out pins and/or interfere with key sensing. Noise current injection into the power supply is best dealt with by shunting the noise aside to chassis ground with capacitors, and further limited using resistors or ferrites.

3.7 RFI PROTECTION

PCB layout, grounding, and the structure of the input circuitry have a great bearing on the success of a design that can withstand strong RF interference.

The circuit is remarkably immune to RFI provided that certain design rules are adhered to:

1. Use SMT components to minimize lead lengths.
2. Connect electrodes to SNSnA, not SNSnB pins.
3. Use a ground plane under and around the circuit and along the sense lines, that is as unbroken as possible except for relief under and beside the sense lines to reduce total Cx. Relieved rear ground planes along the SNS lines should be 'mended' by bridging over them at 1cm intervals with 0.5mm 'rungs' like a ladder.
4. Ground planes and traces should be connected only to a common point near the Vss pins of the IC.
5. Route sense traces away from other traces or wires that are connected to other circuits.
6. Sense electrodes should be kept away from other circuits and grounds which are not directly connected to the sensor's own circuit ground; other grounds will appear to float at high frequencies and couple RF currents into the sense lines.
7. Keep the Cs sampling capacitors and all series-R components close to the IC.
8. Use a 0.1 μ F minimum ceramic bypass cap very close to the Vss / Vdd supply pins.
9. Use series-R's in the sense lines, of as large a value as the circuit can tolerate without degrading sensitivity appreciably.
10. Bypass input power to chassis ground and again at circuit ground to reduce line-injected noise effects. Ferrites over the power wiring may be required to attenuate line injected noise.

Achieving RF immunity requires diligence and a good working knowledge of grounding, shielding, and layout techniques. Very few projects involving these devices will fail EMC tests once properly constructed.

4.1 ABSOLUTE MAXIMUM SPECIFICATIONS

Operating temp.	as designated by suffix
Storage temp.	-55°C to +125°C
V _{DD}	-0.5 to +7.0V
Max continuous pin current, any control or drive pin.....	±20mA
Short circuit duration to ground, any pin.....	infinite
Short circuit duration to V _{DD} , any pin.....	infinite
Voltage forced onto any pin.....	-0.6V to (V _{DD} + 0.6) Volts

4.2 RECOMMENDED OPERATING CONDITIONS

V _{DD}	+3.0 to 5.5V
Operating temperature range, 4.5V - 5.5V (QT140-AS, QT150-AS).....	-40 - +105C
Operating temperature range, 3.0V - 4.5V (QT140-AS, QT150-AS).....	-40 - +85C
Operating temperature range, all voltages (QT140-D, QT150-D).....	0 - +70C
Operating frequency, 4.5V - 5.5V.....	4 - 20MHz
Operating frequency, 3.0V - 5.5V.....	4 - 10MHz
Short-term supply ripple+noise.....	±5mV/s
Long-term supply stability.....	±100mV
C _s value.....	1nF to 200nF
C _x value.....	0 to 100pF

4.3 AC SPECIFICATIONS

V_{DD} = 5.0, T_a = recommended, C_x = 5pF, C_s = 39nF, F_{osc} = 10MHz

Parameter	Description	Min	Typ	Max	Units	Notes
T _{RC}	Recalibration time			330	ms	
T _{PC}	Charge duration		1.2		µs	
T _{PT}	Transfer duration		1.6		µs	
T _{AC}	Acquisition time, all channels		33		ms	
T _{BL}	Burst duration, each channel		3		ms	
N _{BL}	Burst length, each channel		1,000		counts	
T _{BLMR}	Allowable burst duration range	0.1		5.5	ms	Before all timings degrade
T _R	Response time		99		ms	Including detection integrator

4.4 DC SPECIFICATIONS

V_{DD} = 5.0V, C_s = 39nF, C_x = 5pF, F_{osc} = 10MHz, T_a = recommended range, unless otherwise noted

Parameter	Description	Min	Typ	Max	Units	Notes
I _{DD}	Supply current		2.5	8	mA	
V _{DDS}	Supply turn-on slope	100			V/s	Req'd for startup, w/o reset circuit
V _{IL}	Low input logic level			0.7	V	OPT1, OPT2, OC, AKS, SYNC
V _{HL}	High input logic level	2			V	OPT1, OPT2, OC, AKS, SYNC
V _{OL}	Low output voltage			0.6	V	OUTn, SYNC, @ 4mA sink
V _{OH}	High output voltage	V _{DD} -0.7			V	OUTn, 1mA source
I _{IL}	Input leakage current			±1	µA	OPT1, OPT2, OC, AKS
A _R	Acquisition resolution		10	14	bits	

4.5 SIGNAL PROCESSING

[查询"QT140"供应商](#)

Description	Value	Units	Notes
Threshold differential	6	counts	From signal reference
Hysteresis	2	counts	From threshold
Consensus filter length (Detection integrator)	3	samples	
Positive drift compensation rate	990	ms/level	
Negative drift compensation rate	231	ms/level	
Post-detection recalibration timer duration	10, 60, infinite	secs	Option pin selected

All curves at Vdd = 5.0V

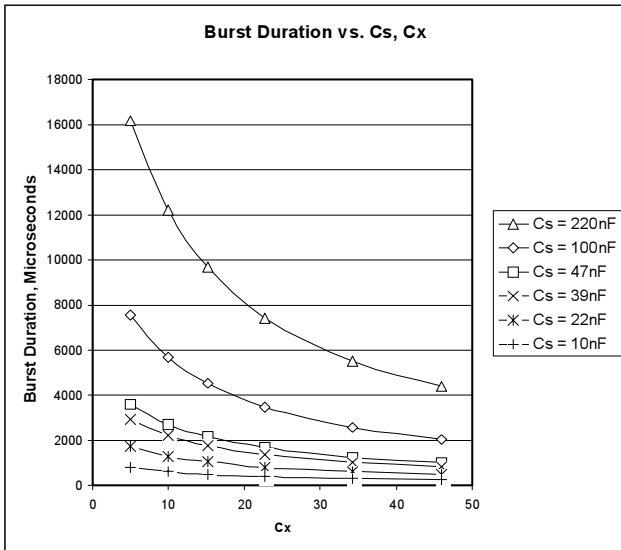

Figure 4-1

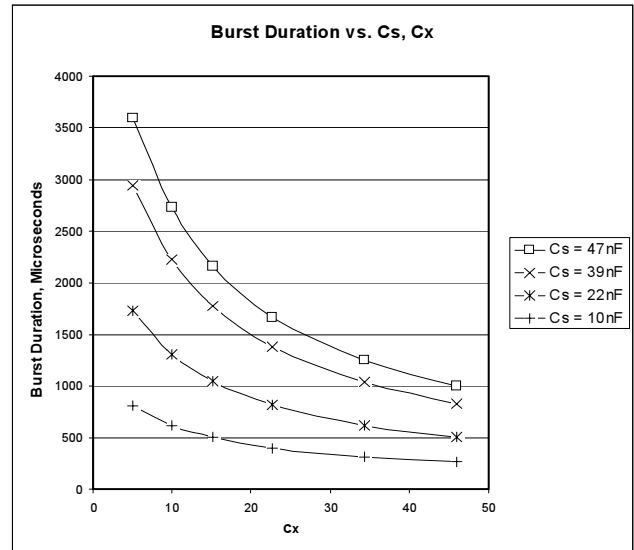

Figure 4-2

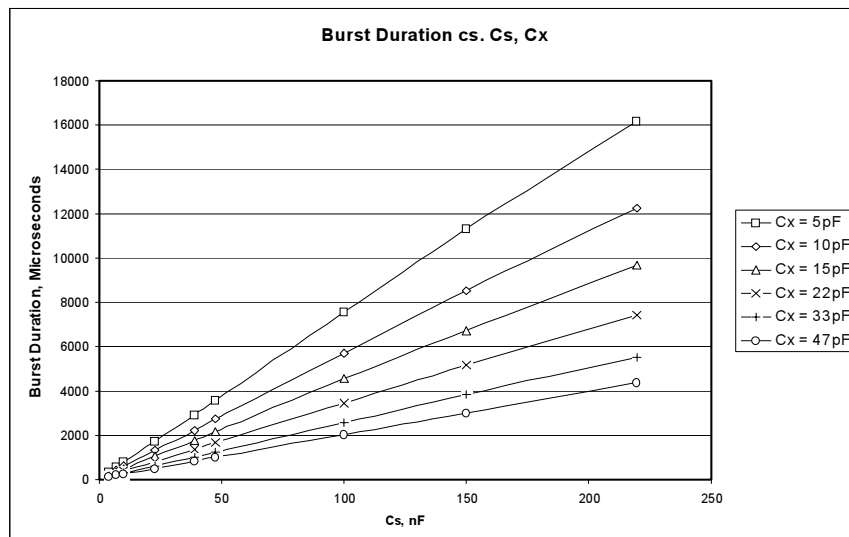
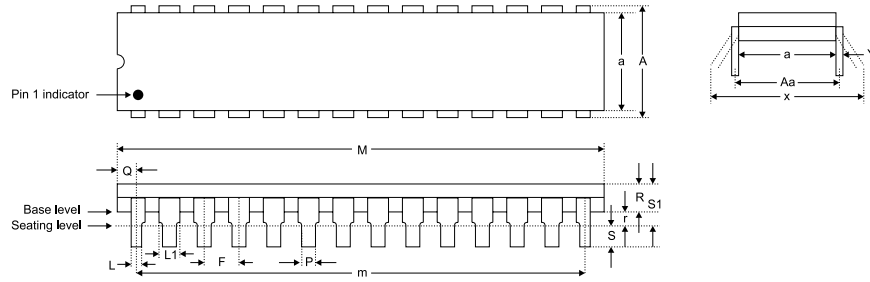

Figure 4-3

5 - PACKAGE OUTLINES

[查询"QT140"供应商](#)



Package type: 28-Pin Dual-In-Line

SYMBOL	Millimeters			Inches		
	Min	Max	Notes	Min	Max	Notes
a	7.112	7.493		0.28	0.295	
A	7.874	8.382		0.31	0.33	
M	34.163	35.179		1.385	1.395	
m	33.02	33.02	BSC	1.3	1.3	BSC
Q	0.584	1.22		0.023	0.048	
P	0.406	0.559		0.016	0.022	
L	0.203	0.508	4 places	0.008	0.02	4 places
L1	1.016	1.651	Typical	0.04	0.065	Typical
F	2.54	2.54	BSC	0.1	0.1	BSC
R	3.175	3.556		0.125	0.14	
r	0.381	-		0.015	-	
S	3.175	3.683		0.125	0.145	
S1	3.632	3.632		0.143	0.18	
Aa	7.874	7.874		0.31	0.31	
x	8.128	9.906		0.32	0.39	
Y	0.203	0.203	Typical	0.008	0.013	Typical

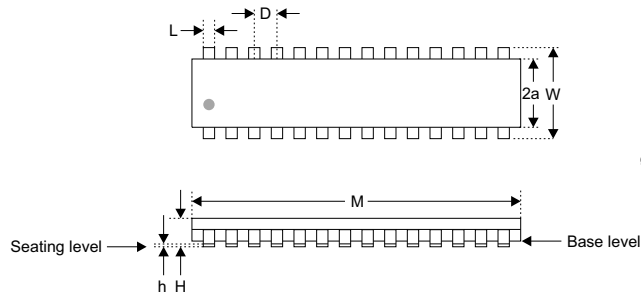

Package type: 28-pin SSOP

SYMBOL	Millimeters			Inches		
	Min	Max	Notes	Min	Max	Notes
M	10.070	10.33		0.396	0.407	
W	7.650	7.9		0.301	0.311	
2a	5.200	5.38		0.205	0.212	
D	0.650	0.65		0.026	0.026	
L	0.250	0.38		0.010	0.015	
E	0.550	0.95		0.022	0.037	
e	0.130	0.22		0.005	0.009	
∅	0°	8°		0°	8°	
H	1.730	1.99		0.068	0.078	
h	0.050	0.21		0.002	0.008	

8 - ORDERING INFORMATION

[查询"QT140"供应商](#)

PART	TEMP RANGE	PACKAGE	MARKING
QT140-D	0 - 70C	PDIP-28	QT140
QT140-AS	-40 - 105C	SSOP-28	QT140-A
QT150-D	0 - 70C	PDIP-28	QT150
QT150-AS	-40 - 105C	SSOP-28	QT150-A



Copyright © 2002 QRG Ltd. All rights reserved.
Patented and patents pending

Corporate Headquarters

1 Mitchell Point
Ensign Way, Hamble SO31 4RF
Great Britain

Tel: +44 (0)23 8056 5600 Fax: +44 (0)23 8045 3939

admin@qprox.com

www.qprox.com

North America

651 Holiday Drive Bldg. 5 / 300
Pittsburgh, PA 15220 USA
Tel: 412-391-7367 Fax: 412-291-1015

The specifications set out in this document are subject to change without notice. All products sold and services supplied by QRG are subject to our Terms and Conditions of sale and supply of services which are available online at www.qprox.com and are supplied with every order acknowledgement. QProx, QTouch, QMatrix, QLevel, and QSlide are trademarks of QRG. QRG products are not suitable for medical (including life-saving equipment), safety or mission critical applications or other similar purposes. Except as expressly set out in QRG's Terms and Conditions, no licenses to patents or other intellectual property of QRG (express or implied) are granted by QRG in connection with the sale of QRG products or provision of QRG services. QRG will not be liable for customer product design and customers are entirely responsible for their products and applications which incorporate QRG's products.