

[查询"563CT-4"供应商](#)

SEMITEC®

Ishizuka Electronics Corporation

PRODUCT CATALOG

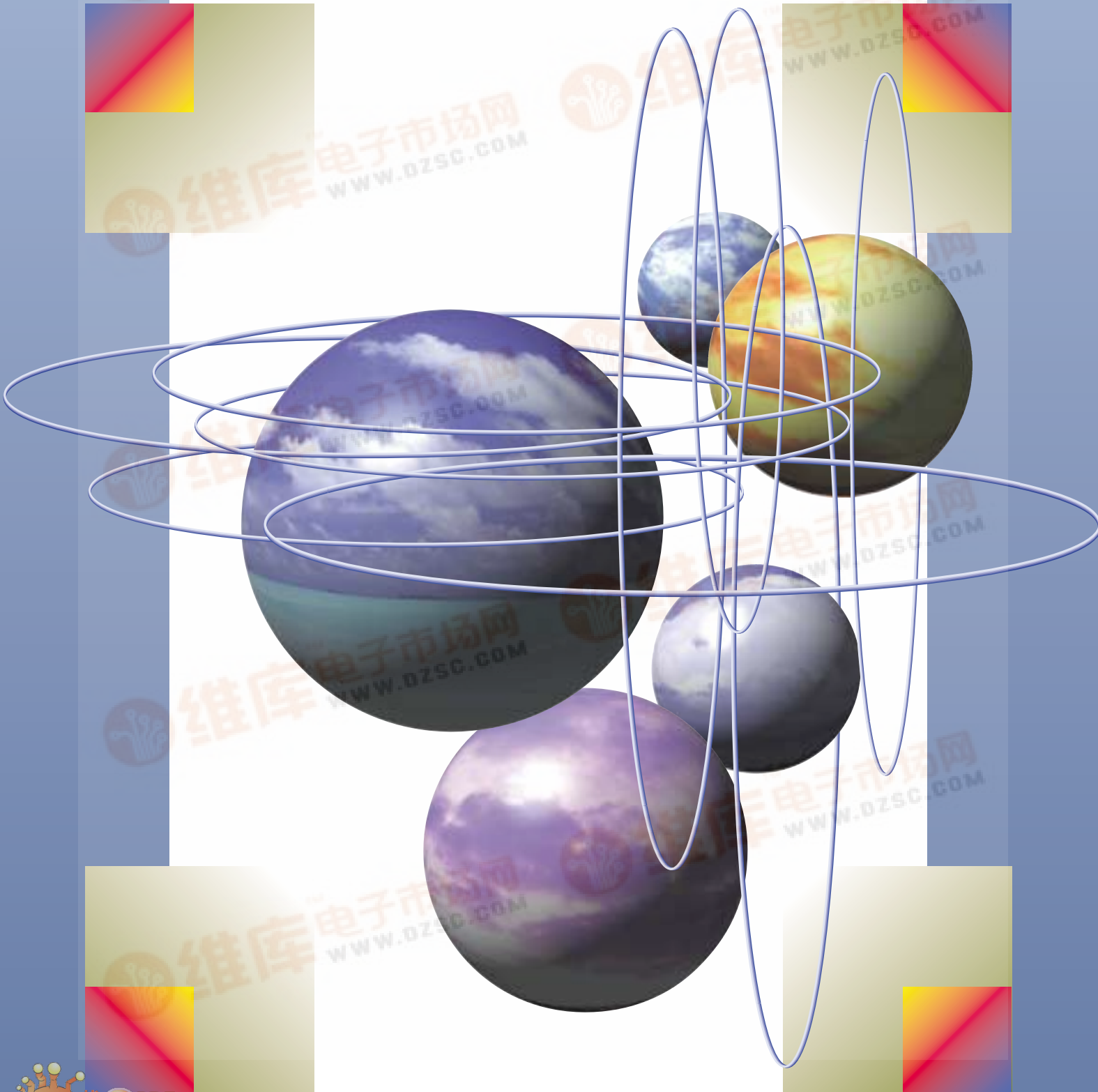

[查询"563CT-4"供应商](#)

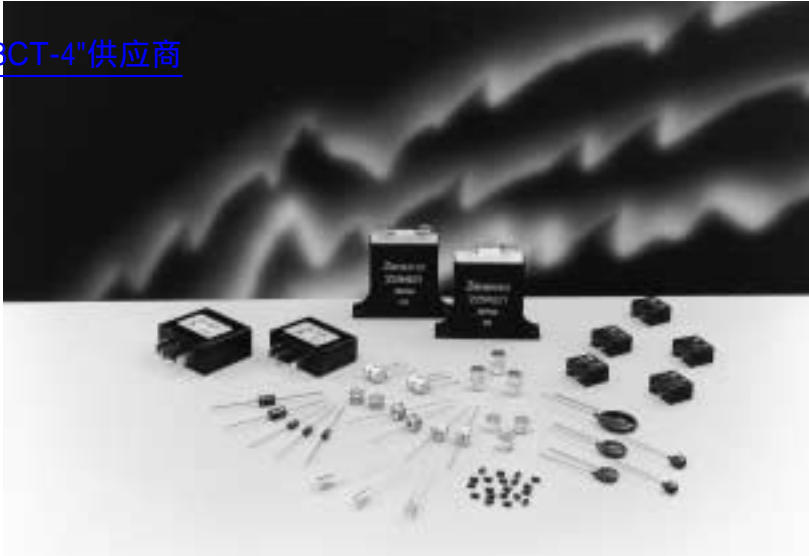

SURGE ABSORBERS

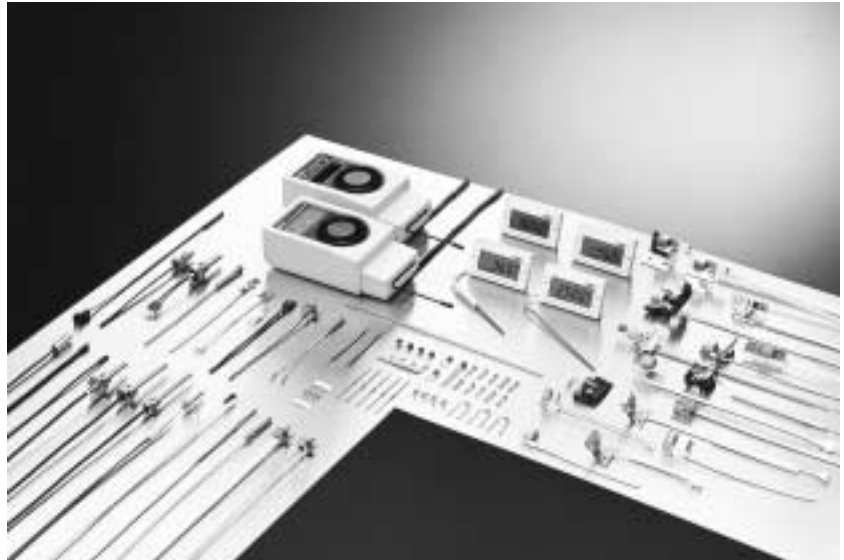

SENSORS AND MODULES



THERMISTORS

| | |
|--|----|
| NON-CONTACT SENSOR <ul style="list-style-type: none">· THERMOPILE· NC SENSOR | 4 |
| THERMISTOR <ul style="list-style-type: none">· HIGH PRECISION SERIES· SMD SERIES· HIGH HEAT-RESISTANCE SERIES· DISK SERIES· SENSORS | 6 |
| POWER THERMISTOR <ul style="list-style-type: none">· D-TYPE SERIES· MARK II SERIES· D2-TYPE SERIES | 21 |
| VRD (TRANSIENT VOLTAGE SUPPRESSOR) <ul style="list-style-type: none">· LEAD TYPE SERIES· SMD SERIES | 26 |
| CRD (CURRENT REGULATIVE DIODE) <ul style="list-style-type: none">· LEAD TYPE SERIES· MELF TYPE SERIES | 30 |
| ZENAMIC (METAL OXIDE VARISTOR) <ul style="list-style-type: none">· LEAD TYPE SERIES· M TYPE SERIES· SURGE ABSORBER UNIT SERIES | 32 |
| GAS TUBE ARRESTER <ul style="list-style-type: none">· CERAMIC TUBE SERIES· GLASS TUBE SERIES· SA-01 SERIES | 40 |

THERMOPILE TYPE INFRARED SENSOR

[查询"563CT-4"供应商](#)

THERMOPILE

Thermopile type Infrared sensor
utilizing own silicon micromachining
technology.

Applications: Eardrum thermometer
Microwave oven
Non contact temperature measurement



Part number

| Part No. | type | Thermistor |
|----------|------|------------|
| 15TP551T | TO5 | Built-in |
| 15TP551N | | — |
| 10TP581T | TO18 | Built-in |

Dimensions

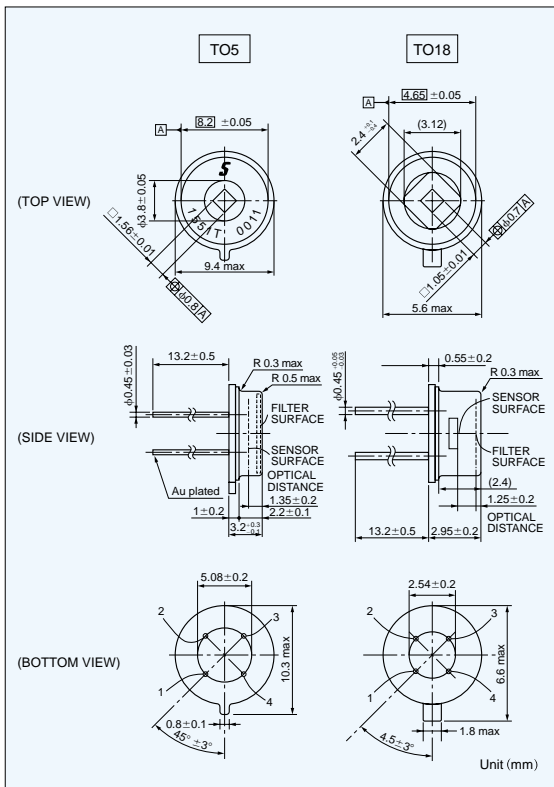

Ratings

| Parameters | Value | | Unit | Conditions |
|--|---------------------|---------------------|-------------------------|--|
| | 15TP551 | 10TP581 | | |
| Sensitive area | 1.56×1.56 | 1.05×1.05 | mm ² | Size of Absorbing Film |
| *1 Responsivity | 16±30% | 15±30% | V/W | |
| *1 Output Voltage | 490±30% | 200±30% | μV | |
| *2 Output Voltage | 2.49±30% | 1.00±30% | mV | |
| *1 Temperature Coefficient of Responsivity | 0.01±0.02 | 0.02±0.02 | % / °C | Reference |
| Thermopile Resistors | 55±30% | 65±30% | kΩ | |
| Temperature Coefficient of Thermopile Resistance | ±0.1 | ±0.1 | % / °C | |
| Johnson Noise Voltage | 30 | 33 | nV / √Hz | Johnson Noise r.m.s., 298K 1Hz Typical |
| *1 S/N Ratio | 84.2 | 75.7 | dB | Output Voltage/Johnson Noise, Typical |
| *1 Noise Equivalent Power | 1.9 | 2.2 | nW / Hz ^{1/2} | Typical |
| *1 Specific Detectivity | 8.4×10 ⁷ | 4.7×10 ⁷ | cm·Hz ^{1/2} /w | Typical |
| Time Constant | 45 | 15 | ms | Typical |
| Operating Temperature range | -20~100 | -20~100 | °C | |
| Storage Temperature range | -40~100 | -40~100 | °C | |
| Filter Range | Cut on 5 | Cut on 5 | μm | Standard |
| Field of View | ±45 | ±50 | deg. | Incident Angle to Achieve 50% Responsivity |
| Insulation Resistance | ≥500 | ≥500 | MΩ | Application of DC25V |
| Sealing | ≤1×10 ⁻⁹ | ≤1×10 ⁻⁹ | Pa·m ³ /s | |
| *3 Thermistor Resistance Value | 100±3% | 100±3% | kΩ | Rated zero-power resistance Value at 25°C |
| *3 Thermistor B-Value | 3435±0.7% | 3435±0.7% | K | |
| *3 Thermistor Rated Power | 0.5 | 0.5 | mW | at 25°C |

*1 Test Condition
Blackbody Temperature : 500K
Sensor-Blackbody Distance : 100mm
Sensor Temperature : 298K
Aperture size : φ12.7mm

*2 Test Condition
Blackbody Temperature : 310K
Sensor Temperature : 298K

*3 Built-in Type

THERMISTOR

"Thermistor" is the generic name given to thermally sensitive resistors. Negative temperature coefficient thermistor is generally called as thermistor. Thermistor is a semiconducting ceramic resistor produced by sintering the materials at high temperature and made mainly from metal oxide. Depending on the manufacturing method and the structure, there are many shapes and characteristics for various purposes such as temperature measurement, temperature compensation and etc. The thermistor resistance values, unless otherwise specified, are classified at a standard temperature of 25°C. B constant is calculated from the resistance values at 25°C and 85°C.

Resistance - Temperature Characteristics

The resistance of a temperature is solely a function of its absolute temperature. Since electrical power being dissipated within a temperature might heat above its ambient temperature and thereby reduce its resistance, it is necessary to test for resistance with temperature. The resistance so measured is called R_T , which means the resistance at essentially zero-power.

The mathematical expression which relates the resistance and the absolute temperature of a thermistor is as follows:

$$R_a = R_b \exp \left[B \left(\frac{1}{T_1} - \frac{1}{T_2} \right) \right]$$

Where: R_a is the resistance at absolute temperature T_1
 R_b is the resistance at absolute temperature T_2
 B is a constant which depends on the material of the thermistor

Unless otherwise specified, all values of B are determined from measurements made at 25°C and 85°C.

The temperature coefficient of resistance α is expressed in the following equation:

$$\alpha = -\frac{B}{T^2} \times 100 (\%/^{\circ}\text{C})$$

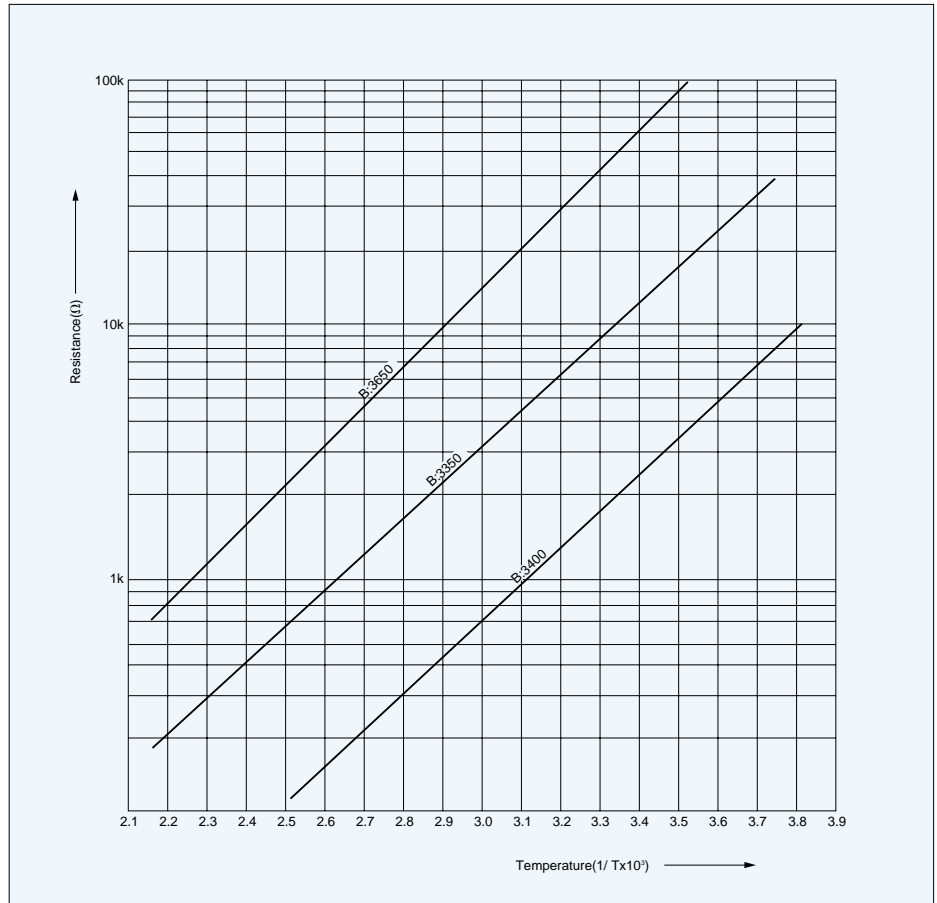

Dissipation factor

Dissipation factor (δ) is power in milliwatts required to raise thermistor temperature 1°C. Measured with thermistor suspended by its leads in a specified environment.

$$\delta = \frac{P}{\Delta t} (\text{mW}/^{\circ}\text{C})$$

P : Power (mW)
 Δt : Raise temperature (°C)

Thermal time constant

Thermal time constant (τ_a) is the time required by a thermistor to change 63% of the difference between its initial and final temperature. Measured with thermistor suspended by its leads in specified environment.

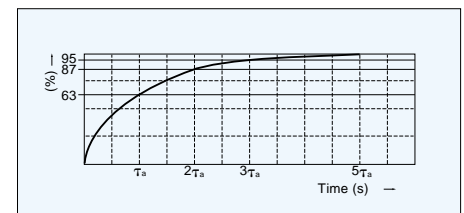

ULTIMATE THINNESS, JT THERMISTOR

500 μ m only

[查询"563CT-4"供应商](#)

JT THERMISTOR

JT thermistors feature ultra thinness of 500 μ m and superior electrical insulation. It is possible to use with safety in ambience that might contact with electrodes.

Part number

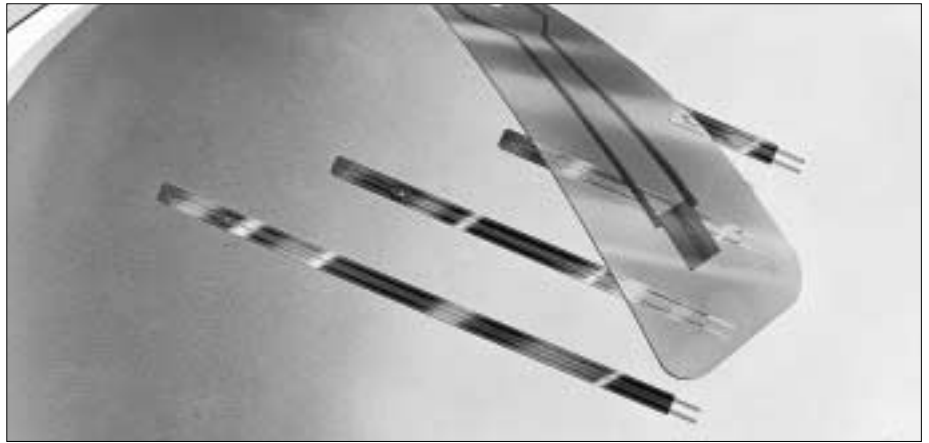
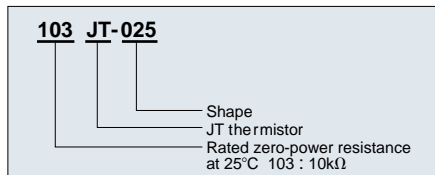

Dimensions

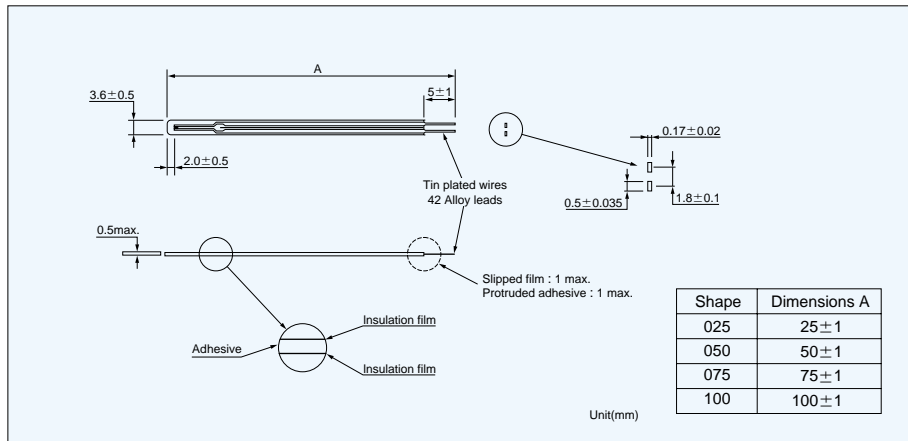

Resistance-Temperature

| Temperature (°C) | Type | |
|------------------|-------|-------|
| | 103JT | 104JT |
| -50 | 367.7 | 9584 |
| -40 | 204.7 | 4572 |
| -30 | 118.5 | 2282 |
| -20 | 71.02 | 1191 |
| -10 | 43.67 | 647.2 |
| 0 | 27.70 | 365.0 |
| 10 | 18.07 | 212.5 |
| 20 | 12.11 | 127.7 |
| 30 | 8.301 | 78.88 |
| 40 | 5.811 | 50.03 |
| 50 | 4.147 | 32.51 |
| 60 | 3.011 | 21.61 |
| 70 | 2.224 | 14.66 |
| 80 | 1.668 | 10.13 |
| 90 | 1.267 | 7.135 |
| 100 | | 5.111 |
| 110 | | 3.720 |
| 120 | | 2.746 |
| 125 | | 2.371 |

Unit(k Ω)

Specifications

| Part No. | R ₂₅ *1 | B value*2 | Dissipation factor (mW/°C) | Thermal time constant(s)*3 | Rated power at 25°C(mW) | Operating temp. range(°C) |
|-----------|------------------------|----------------|----------------------------|----------------------------|-------------------------|---------------------------|
| 103JT-□□□ | 10k Ω \pm 1% | 3435K \pm 1% | 0.7 | 5 | 3.5 | -50~90 |
| 104JT-□□□ | 100k Ω \pm 1% | 4390K \pm 1% | 0.7 | 5 | 3.5 | -50~125 |

*1 R₂₅ : Rated zero-power resistance value at 25°C, \pm 2% and 3% are also available.

*2 B value : determined by rated zero-power resistance at 25°C and 85°C.

*3 Time when thermistor temperature reaches 63.2% of the temperature difference. The value is measured in the air.

HIGH PRECISION THERMISTOR

[查询"563CT-4"供应商](#)

AT THERMISTOR

The AT thermistor is a high-precision thermal sensing device featuring extremely small B-value tolerance and resistance.

When used as a temperature gauge, the AT thermistor requires no adjustment between the control circuit and the sensor.

This insures temperature precision of $\pm 0.3^{\circ}\text{C}$. Temperature indicators and control instruments are now available for use with the thermistor.

Part number

102 AT-2

- 102: Shape
- AT: High-precision AT thermistor
- 2: Rated zero-power
- Resistance at 25°C 102 : 1(k Ω)



Dimensions

AT-11
 Dimensions: 5 max. (tip length), 6±0.2 (tip diameter), 15 max. (tip length), 600⁺²⁰ (total length), 5±1 (lead length).
 Components: Marking, 0.3sq TPE lead wire, Soldered.

AT-2
 Dimensions: 3.8 max. (tip length), 8.5±1 (tip length), 4.0 max. (tip length), 0.7 (tip diameter), 17±1.5 (total length), 2.54±0.25 (lead length).
 Components: Color code, Epoxy, 0.5[#]Tin-Plated 42 Alloy.

AT-3
 Dimensions: 3.8 max. (tip length), 8.5±1 (tip length), 4.0 max. (tip length), 1.0 (tip diameter), 17±1.5 (total length), 2.54±0.25 (lead length).
 Components: Color code, Epoxy, 0.5[#]Tin-Plated 42 Alloy.

AT-4
 Shape1: Dimensions: 2.5 max. (tip length), 8 max. (tip length), 40~100 (total length), (3) (lead length).
 Components: Epoxy, UL1685 AWG30.
 Shape2: Dimensions: 4 max. (tip length), 13 max. (tip length), (30) (tip length), 100~225 (total length), (5) (lead length).
 Components: Epoxy resin, HVFF 0.14sq.

AT-2SS
 Dimensions: 4.0~4.5 (tip length), 2.9~3.3 (tip length), 0.6 (tip diameter), 0.7 (tip diameter), 0.35 (tip diameter), 8.5±1 (total length), 17±1.5 (total length), 2.54±0.25 (lead length).
 Components: Color code, Epoxy, 0.25t Tin plated 42 Alloy leads.

Resistance tolerance

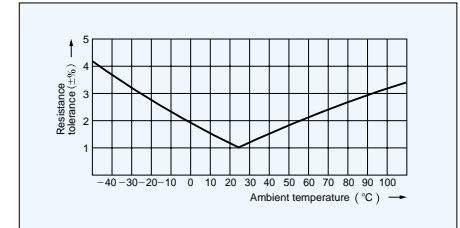

Interchange precision

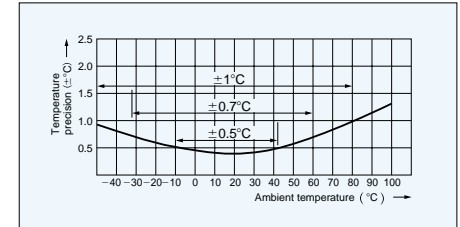

Specifications

| Part No | R ₂₅ ^{#1} | B value ^{#2} | Dissipation factor (mW/°C) | Thermal time constant (s) ^{#3} | Rated power at 25°C (mW) | Operating temp. range(°C) | Color code |
|----------------|-------------------------------|-----------------------|----------------------------|---|--------------------------|---------------------------|------------|
| 102AT-2 | 1.0k Ω ±1% | 3100K±1% | 2 | 15 | 10 | -50~90 | Black |
| 202AT-2 | 2.0k Ω ±1% | 3182K±1% | 2 | 15 | 10 | -50~90 | Red |
| 502AT-2 | 5.0k Ω ±1% | 3324K±1% | 2 | 15 | 10 | -50~110 | Yellow |
| 103AT-2 | 10.0k Ω ±1% | 3435K±1% | 2 | 15 | 10 | -50~110 | White |
| 203AT-2 | 20.0k Ω ±1% | 4013K±1% | 2 | 15 | 10 | -50~110 | None |
| 503AT-2 | 50.0k Ω ±3% | 4060K±1% | 2 | 15 | 10 | -50~110 | None |
| 104AT-2 | 100.0k Ω ±1% | 4665K±1% | 2 | 15 | 10 | -50~110 | None |
| 103AT-3 | 10.0k Ω ±1% | 3435K±1% | 2 | 15 | 10 | -50~110 | White |
| 102AT-11 | 1.0k Ω ±1% | 3100K±1% | 3 | 75 | 15 | -50~90 | None |
| 202AT-11 | 2.0k Ω ±1% | 3182K±1% | 3 | 75 | 15 | -50~90 | None |
| 502AT-11 | 5.0k Ω ±1% | 3324K±1% | 3 | 75 | 15 | -50~105 | None |
| 103AT-11 | 10.0k Ω ±1% | 3435K±1% | 3 | 75 | 15 | -50~105 | None |
| 103AT-4 Shape1 | 10.0k Ω ±1% | 3435K±1% | 2 | 10 | 10 | -30~90 | None |
| 103AT-4 Shape2 | 10.0k Ω ±1% | 3435K±1% | 4 | 35 | 20 | -30~90 | None |
| 103AT-2S | 10.0k Ω ±1% | 3435K±1% | 1 | 15 | 5 | -50~110 | white |
| 103AT-2SS | 10.0k Ω ±1% | 3435K±1% | 1 | 15 | 5 | -50~110 | white |

*Other resistance is also available, please ask.

#1 R₂₅: Rated zero-power resistance value at 25°C.

#2 B value: determined by rated zero-power resistance at 25°C and 85°C.

#3 T time when thermistor temperature reaches 63.2% of the temperature difference. The value is measured in the air.

AT-5 THERMISTOR

AT-5 thermistor is available in taping.

Part number

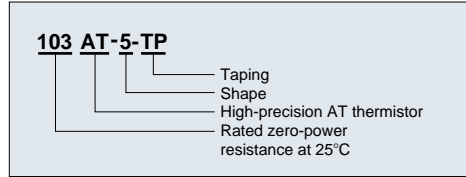

Dimensions

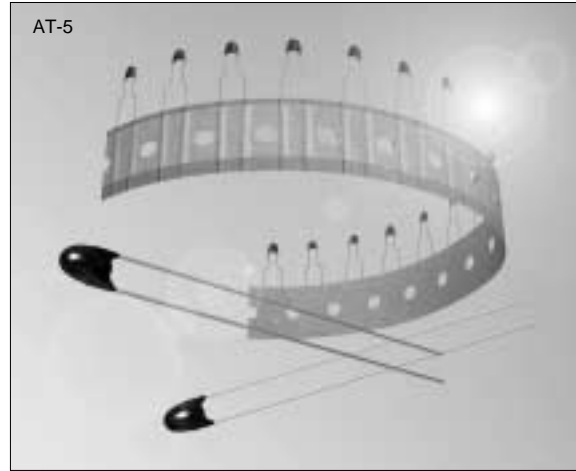
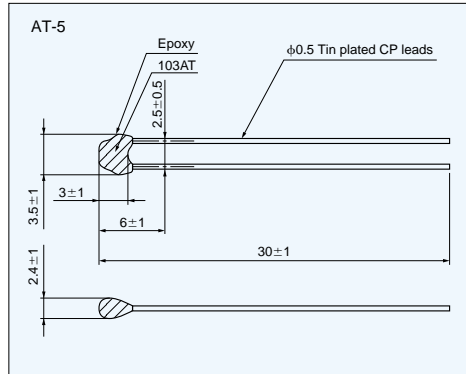

Specifications

| Part No | R ₂₅ ※1 | B value ※2 | Dissipation factor (mW/°C) | Thermal time constant (s) ※3 | Rated power at 25°C (mW) | Operating temp. range(°C) |
|---------|--------------------|------------|----------------------------|------------------------------|--------------------------|---------------------------|
| 103AT-5 | 10.0kΩ±1% | 3435K±1% | 2.5 | 15 | 10 | -50~110 |

※Other resistance is also available, please ask.

※1 R₂₅: Rated zero-power resistance value at 25°C.

※2 B value: determined by rated zero-power resistance at 25°C and 85°C.

※3 Time when thermistor temperature reaches 63.2% of the temperature difference. The value is measured in the air.

Taping

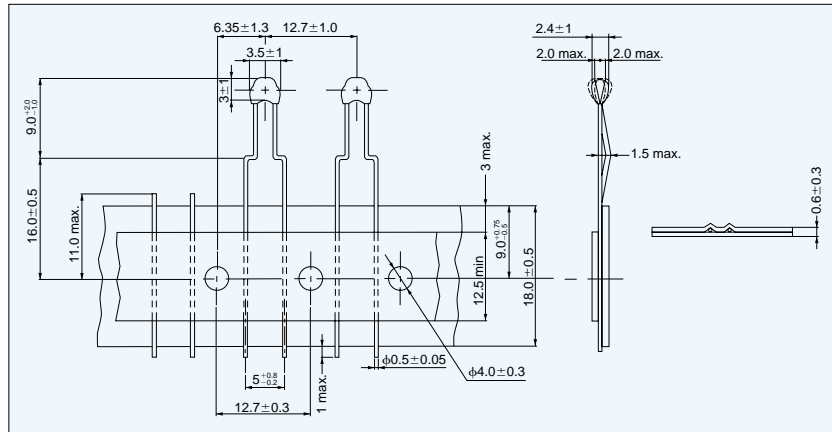

Resistance -Temperature

| Temperature (°C) | Type | | | | | | | Temperature (°C) | Type | | | | | | |
|------------------|--------|-------|-------|-------|-------|-------|-------|------------------|--------|--------|--------|--------|--------|-------|-------|
| | 102AT | 202AT | 502AT | 103AT | 203AT | 503AT | 104AT | | 102AT | 202AT | 502AT | 103AT | 203AT | 503AT | 104AT |
| -50 | 24.46 | 55.66 | 154.6 | 329.5 | 1253 | 3168 | 11473 | 35 | 0.7229 | 1.424 | 3.508 | 6.940 | 13.06 | 32.48 | 60.94 |
| -45 | 18.68 | 42.17 | 116.5 | 247.7 | 890.5 | 2257 | 7781 | 40 | 0.6189 | 1.211 | 2.961 | 5.827 | 10.65 | 26.43 | 48.10 |
| -40 | 14.43 | 32.34 | 88.91 | 188.5 | 642.0 | 1632 | 5366 | 45 | 0.5316 | 1.033 | 2.509 | 4.911 | 8.716 | 21.59 | 38.13 |
| -35 | 11.23 | 24.96 | 68.19 | 144.1 | 465.8 | 1186 | 3728 | 50 | 0.4587 | 0.8854 | 2.137 | 4.160 | 7.181 | 17.75 | 30.44 |
| -30 | 8.834 | 19.48 | 52.87 | 111.3 | 342.5 | 872.8 | 2629 | 55 | 0.3967 | 0.7620 | 1.826 | 3.536 | 5.941 | 14.64 | 24.42 |
| -25 | 6.998 | 15.29 | 41.21 | 86.43 | 253.6 | 646.3 | 1864 | 60 | 0.3446 | 0.6587 | 1.567 | 3.020 | 4.943 | 12.15 | 19.72 |
| -20 | 5.594 | 12.11 | 32.44 | 67.77 | 190.0 | 484.3 | 1340 | 65 | 0.3000 | 0.5713 | 1.350 | 2.588 | 4.127 | 10.13 | 15.99 |
| -15 | 4.501 | 9.655 | 25.66 | 53.41 | 143.2 | 364.6 | 969.0 | 70 | 0.2622 | 0.4975 | 1.168 | 2.228 | 3.464 | 8.482 | 13.05 |
| -10 | 3.651 | 7.763 | 20.48 | 42.47 | 109.1 | 277.5 | 709.5 | 75 | 0.2285 | 0.4343 | 1.014 | 1.924 | 2.916 | 7.129 | 10.68 |
| -5 | 2.979 | 6.277 | 16.43 | 33.90 | 83.75 | 212.3 | 523.3 | 80 | 0.1999 | 0.3807 | 0.8835 | 1.668 | 2.468 | 6.022 | 8.796 |
| 0 | 2.449 | 5.114 | 13.29 | 27.28 | 64.88 | 164.0 | 390.3 | 85 | 0.1751 | 0.3346 | 0.7722 | 1.451 | 2.096 | 5.105 | 7.271 |
| 5 | 2.024 | 4.188 | 10.80 | 22.05 | 50.53 | 127.5 | 292.5 | 90 | 0.1536 | 0.2949 | 0.6771 | 1.266 | 1.788 | 4.345 | 6.041 |
| 10 | 1.684 | 3.454 | 8.840 | 17.96 | 39.71 | 99.99 | 221.5 | 95 | | | 0.5961 | 1.108 | 1.530 | 3.712 | 5.037 |
| 15 | 1.408 | 2.862 | 7.267 | 14.69 | 31.36 | 78.77 | 168.6 | 100 | | | 0.5265 | 0.9731 | 1.315 | 3.185 | 4.220 |
| 20 | 1.184 | 2.387 | 6.013 | 12.09 | 24.96 | 62.56 | 129.5 | 105 | | | 0.4654 | 0.8572 | 1.134 | 2.741 | 3.546 |
| 25 | 1.000 | 2.000 | 5.000 | 10.00 | 20.00 | 50.00 | 100.0 | 110 | | | 0.4128 | 0.7576 | 0.9807 | 2.369 | 2.994 |
| 30 | 0.8486 | 1.684 | 4.179 | 8.313 | 16.12 | 40.20 | 77.81 | | | | | | | | |

Unit(kΩ)

ET THERMISTOR

The ET thermistor is smaller version of the AT thermistor. Its fast response time and high reliability makes it particularly suitable for use in medical equipment and thermometers. Manufactured by full-automated production line, all ET thermistors have identical size and that makes it possible to assemble sensors automatically.

Part number

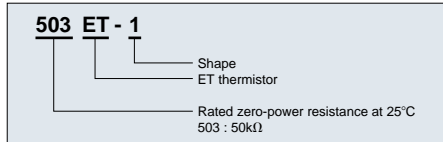

Dimensions

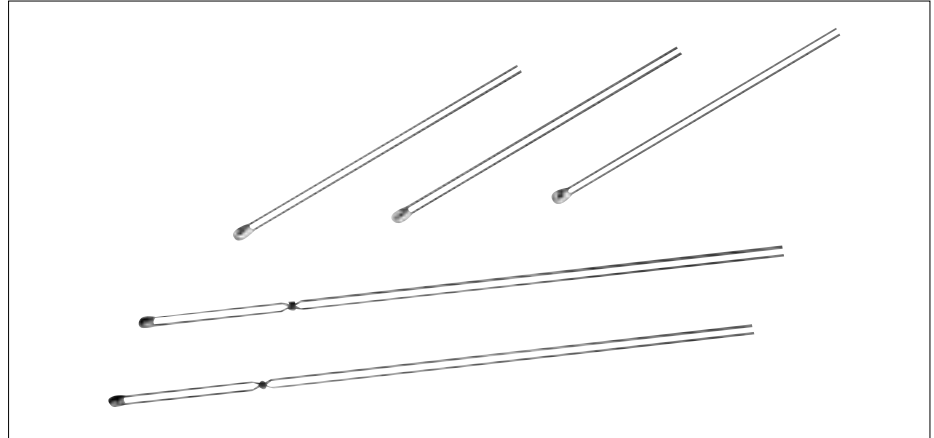
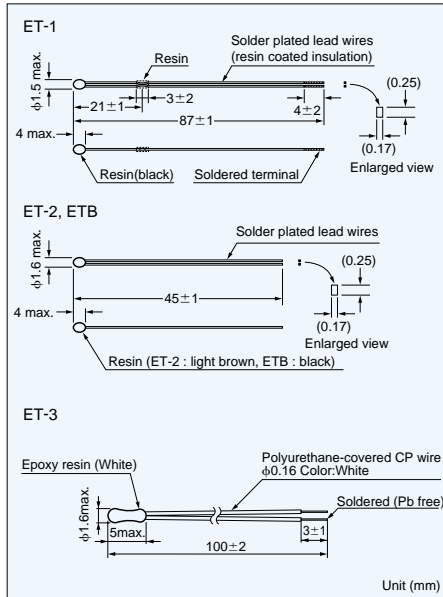

Specifications

| Part No. | R ₂₅ *1 | B value*2 | Dissipation factor (mW/°C) | Thermal time constant (s)*3 | Rated power at 25°C(mW) | Operating temp. range (°C) |
|------------|--------------------|-----------|----------------------------|-----------------------------|-------------------------|----------------------------|
| 402ET-1(2) | 4.0kΩ±3% | 3100K±1% | 0.7 | 6 | 3.5 | -40~ 90 |
| 103ET-1(2) | 10.0kΩ±3% | 3250K±1% | 0.7 | 6 | 3.5 | -40~ 90 |
| 303ET-1(2) | 30.0kΩ±3% | 3760K±1% | 0.7 | 6 | 3.5 | -40~100 |
| 403ET-1(2) | 40.0kΩ±3% | 3525K±1% | 0.7 | 6 | 3.5 | -40~100 |
| 413ET-1(2) | 41.0kΩ±3% | 3435K±1% | 0.7 | 6 | 3.5 | -40~100 |
| 503ET-1(2) | 50.0kΩ±3% | 4055K±1% | 0.7 | 6 | 3.5 | -40~100 |
| 593ET-1(2) | 59.0kΩ±3% | 3617K±1% | 0.7 | 6 | 3.5 | -40~100 |
| 833ET-1(2) | 83.0kΩ±3% | 4013K±1% | 0.7 | 6 | 3.5 | -40~100 |
| 104ET-1(2) | 100.0kΩ±3% | 4132K±1% | 0.7 | 6 | 3.5 | -40~ 90 |
| 224ET-1(2) | 226.0kΩ±3% | 4021K±1% | 0.7 | 6 | 3.5 | -40~100 |
| 234ET-1(2) | 232.0kΩ±3% | 4274K±1% | 0.7 | 6 | 3.5 | -40~100 |
| 103ETB | 10.0kΩ±2% | 3435K±1% | 0.7 | 6 | 3.5 | -40~ 90 |
| 503ET-3 | 50.0kΩ±2% | 4086K±1% | 0.7 | 6 | 3.5 | -40~100 |

*1 R₂₅: Rated zero-power resistance value at 25°C.
 *2 B value: determined by rated zero-power resistance at 25°C and 85°C.
 *3 Time when thermistor temperature reaches 63.2% of the temperature difference. The value is measured in the air.

Resistance-Temperature

| Temperature (°C) | Type | | | | | | | | | | | |
|------------------|--------|-------|-------|-------|-------|-------|-------|-------|-------|-------|-------|--------|
| | 402ET | 103ET | 303ET | 403ET | 413ET | 503ET | 593ET | 833ET | 104ET | 224ET | 234ET | 103ETB |
| -40 | 57.71 | 170.9 | 810.7 | 833.3 | 772.8 | 1602 | 1318 | 2664 | 3325 | 7005 | 9046 | 204.7 |
| -30 | 35.34 | 102.2 | 445.1 | 481.1 | 456.5 | 855.0 | 754.3 | 1421 | 1769 | 3784 | 4680 | 118.5 |
| -20 | 22.38 | 63.07 | 253.7 | 287.5 | 277.9 | 474.4 | 445.8 | 788.5 | 977.5 | 2116 | 2515 | 71.02 |
| -10 | 14.60 | 40.08 | 149.8 | 177.2 | 174.1 | 272.7 | 271.7 | 453.0 | 559.0 | 1225 | 1401 | 43.67 |
| 0 | 9.797 | 26.16 | 91.30 | 112.4 | 111.7 | 161.9 | 170.1 | 269.3 | 329.8 | 730.1 | 808.2 | 27.70 |
| 10 | 6.737 | 17.51 | 57.31 | 73.00 | 73.63 | 99.13 | 109.4 | 164.8 | 200.5 | 447.8 | 480.2 | 18.07 |
| 20 | 4.736 | 11.99 | 37.00 | 48.61 | 49.57 | 62.38 | 72.10 | 103.6 | 125.3 | 282.1 | 293.7 | 12.11 |
| 30 | 3.394 | 8.387 | 24.47 | 33.08 | 34.08 | 40.24 | 48.55 | 66.91 | 80.27 | 182.1 | 184.4 | 8.301 |
| 40 | 2.476 | 5.988 | 16.56 | 22.96 | 23.89 | 26.58 | 33.41 | 44.18 | 52.62 | 120.3 | 118.6 | 5.811 |
| 50 | 1.835 | 4.353 | 11.45 | 16.26 | 17.06 | 17.93 | 23.44 | 29.80 | 35.23 | 81.07 | 78.00 | 4.147 |
| 60 | 1.378 | 3.217 | 8.070 | 11.70 | 12.38 | 12.33 | 16.73 | 20.51 | 24.00 | 55.75 | 52.39 | 3.011 |
| 70 | 1.049 | 2.414 | 5.791 | 8.569 | 9.135 | 8.588 | 12.15 | 14.37 | 16.59 | 39.01 | 35.87 | 2.224 |
| 80 | 0.7997 | 1.836 | 4.222 | 6.367 | 6.838 | 6.064 | 8.951 | 10.24 | 11.64 | 27.78 | 24.99 | 1.668 |
| 90 | 0.6145 | 1.416 | 3.125 | 4.797 | 5.190 | 4.338 | 6.697 | 7.419 | 8.287 | 20.10 | 17.72 | 1.267 |
| 100 | | | 2.346 | 3.662 | 3.990 | 3.142 | 5.077 | 5.459 | | 14.75 | 12.75 | |

Unit (kΩ)

Specifications for clinical thermo-meter

| Temperature (°C) | Type | | | |
|------------------------|-------|-------|-------|-------|
| | 503ET | 833ET | 224ET | 234ET |
| R ₃₀ | 40.22 | 67.04 | 182.4 | 184.5 |
| R ₃₇ | 30.00 | 50.00 | 136.0 | 135.0 |
| R ₄₅ | 21.75 | 36.25 | 98.56 | 95.87 |
| B _{30/45} (K) | 3953 | 3953 | 3958 | 4209 |

Unit (kΩ)

ACCURATE AXIAL TYPE THERMISTOR

[查询"563CT-4"供应商](#)

IT THERMISTOR

Our newly developed IT thermistors are axial leaded diode type packaged in high-density resin mold and featured strength against various operating environments.
We offer IT thermistor with $\pm 2\%$ tolerance for a resistance value of 25°C and $\pm 1\%$ for B value.
IT thermistors are the most appropriate device for accurate temperature control below 100°C.

Part number

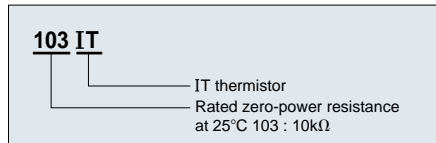

Dimensions

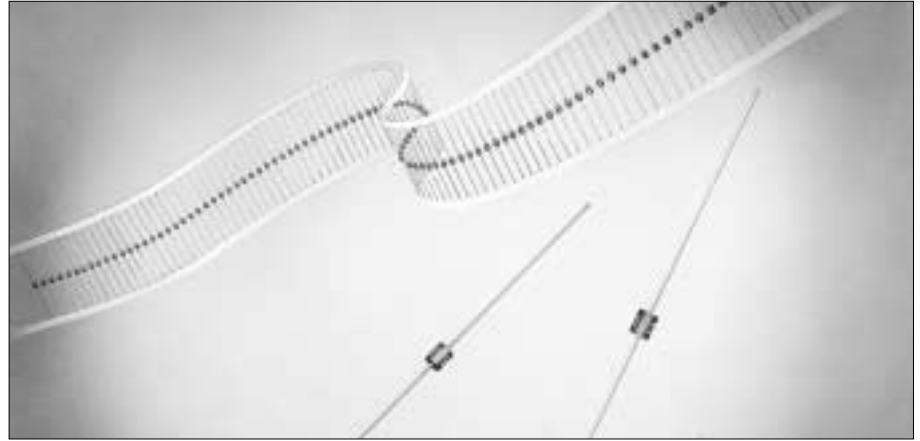
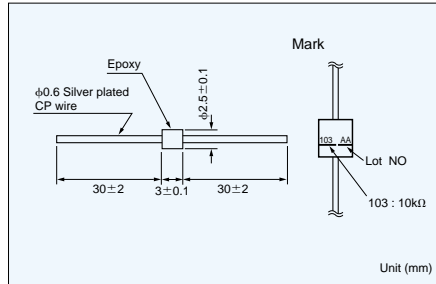

Package

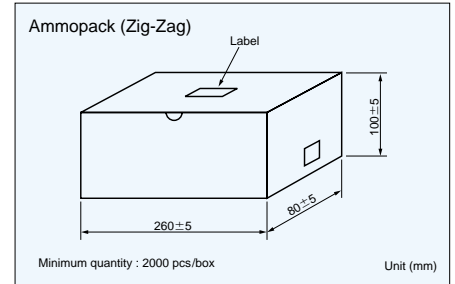
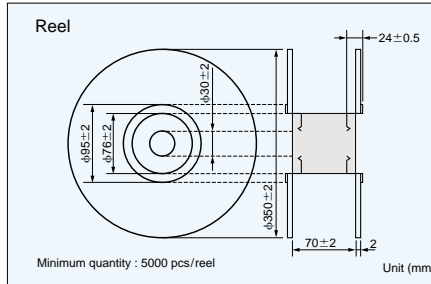

Taping

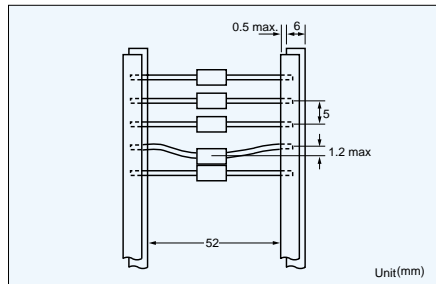

Specifications

| Part No. | R ₂₅ *1 | B value*2 | Dissipation factor (mW/°C) | Thermal time constant (s)*3 | Rated power at 25°C (mW) | Operating temp. range (°C) |
|----------|--------------------|-----------|----------------------------|-----------------------------|--------------------------|----------------------------|
| 302IT | 3.0kΩ±2% | 3860K±1% | 3.6 | 13.5 | 18.0 | -50~125 |
| 502IT | 5.0kΩ±2% | 3860K±1% | 3.6 | 13.5 | 18.0 | -50~125 |
| 103IT | 10.0kΩ±2% | 3435K±1% | 3.6 | 13.5 | 18.0 | -50~100 |
| 203IT | 20.0kΩ±2% | 3760K±1% | 3.6 | 13.5 | 18.0 | -50~125 |
| 303IT | 30.0kΩ±2% | 3760K±1% | 3.6 | 13.5 | 18.0 | -50~125 |
| 503IT | 50.0kΩ±2% | 4055K±1% | 3.6 | 13.5 | 18.0 | -50~125 |
| 104IT | 100.0kΩ±2% | 4390K±1% | 3.6 | 13.5 | 18.0 | -50~125 |

*1 R₂₅ : Rated zero-power resistance value at 25°C, $\pm 1\%$ and 3% are also available.

*2 B value : determined by rated zero-power resistance at 25°C and 85°C.

*3 Time when thermistor temperature reaches 63.2% of the temperature difference. The value is measured in the air.

Resistance-Temperature

| Temperature (°C) | Type | | | | | | | | Temperature (°C) | Type | | | | | | | |
|------------------|-------|-------|-------|-------|-------|-------|-------|-------|------------------|--------|--------|--------|-------|-------|-------|--|--|
| | 302IT | 502IT | 103IT | 203IT | 303IT | 503IT | 104IT | 302IT | | 502IT | 103IT | 203IT | 303IT | 503IT | 104IT | | |
| -50 | 182.1 | 303.4 | 367.7 | 1026 | 1539 | 3135 | 9584 | 50 | 1.109 | 1.849 | 4.147 | 7.632 | 11.45 | 17.93 | 32.51 | | |
| -40 | 93.35 | 155.6 | 204.7 | 540.5 | 810.8 | 1602 | 4572 | 60 | 0.7744 | 1.291 | 3.011 | 5.380 | 8.070 | 12.33 | 21.61 | | |
| -30 | 49.85 | 83.09 | 118.5 | 296.7 | 445.1 | 855.0 | 2282 | 70 | 0.5513 | 0.9189 | 2.224 | 3.861 | 5.792 | 8.588 | 14.66 | | |
| -20 | 27.75 | 46.25 | 71.02 | 169.2 | 253.8 | 474.4 | 1191 | 80 | 0.4000 | 0.6667 | 1.668 | 2.815 | 4.223 | 6.064 | 10.13 | | |
| -10 | 16.02 | 26.70 | 43.67 | 99.85 | 149.8 | 272.7 | 647.2 | 90 | 0.2951 | 0.4918 | 1.267 | 2.083 | 3.125 | 4.338 | 7.135 | | |
| 0 | 9.541 | 15.90 | 27.70 | 60.87 | 91.31 | 161.9 | 365.0 | 100 | 0.2210 | 0.3683 | 0.9753 | 1.564 | 2.346 | 3.142 | 5.111 | | |
| 10 | 5.876 | 9.793 | 18.07 | 38.21 | 57.32 | 99.13 | 212.5 | 110 | 0.1680 | 0.2800 | | 1.190 | 1.785 | 2.302 | 3.720 | | |
| 20 | 3.728 | 6.214 | 12.11 | 24.66 | 36.99 | 62.38 | 127.7 | 120 | 0.1295 | 0.2158 | | 0.9159 | 1.374 | 1.705 | 2.746 | | |
| 30 | 2.431 | 4.051 | 8.301 | 16.31 | 24.47 | 40.24 | 78.88 | 125 | 0.1142 | 0.1903 | | 0.8067 | 1.210 | 1.472 | 2.371 | | |
| 40 | 1.623 | 2.705 | 5.811 | 11.04 | 16.56 | 26.58 | 50.03 | | | | | | | | | | |

Unit (kΩ)

SURFACE MOUNT TYPE THERMISTOR

[查询"563CT-4"供应商](#)

HT THERMISTOR

HT thermistors are entirely new type of thermistor for surface mounting (by reflow soldering) and were acquired from advanced technology.

Our HT thermistors are adapted metal electrodes packaged in a resin mold, unlike conventional chip thermistors, and can offer $\pm 2\%$ tolerance for a resistance value at 25°C.

HT series (SMD Thermistor) is not only compact-surface mounting type but also highly accurate and reliable.

Part number

| | | | |
|------------|-----------|------------|---|
| 103 | HT | -□□ | -TP |
| | | | Taping HTF only |
| | | | Tolerance of R ₂₅ |
| | | | 1P: $\pm 1\%$ 2P: $\pm 2\%$ |
| | | | Shape |
| | | | Rated zero-power resistance at 25°C 103: 10k Ω |

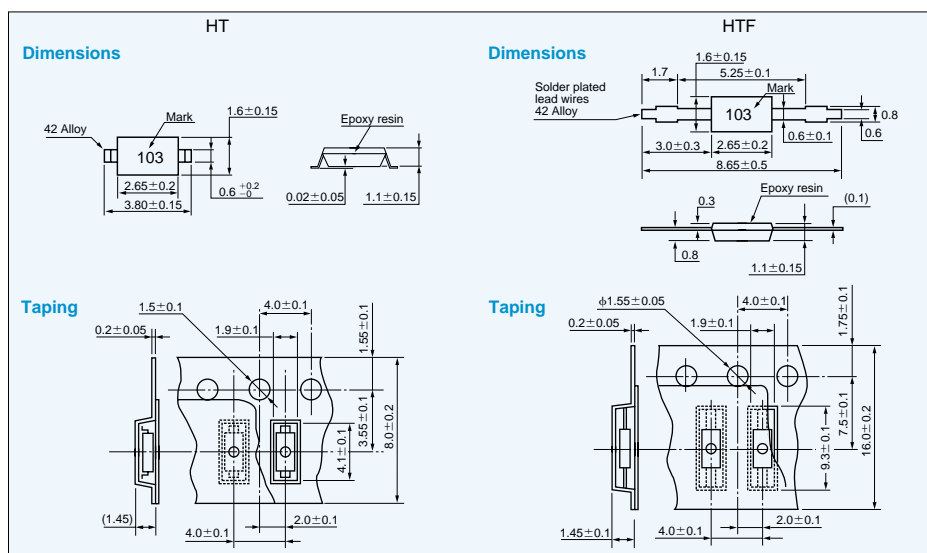
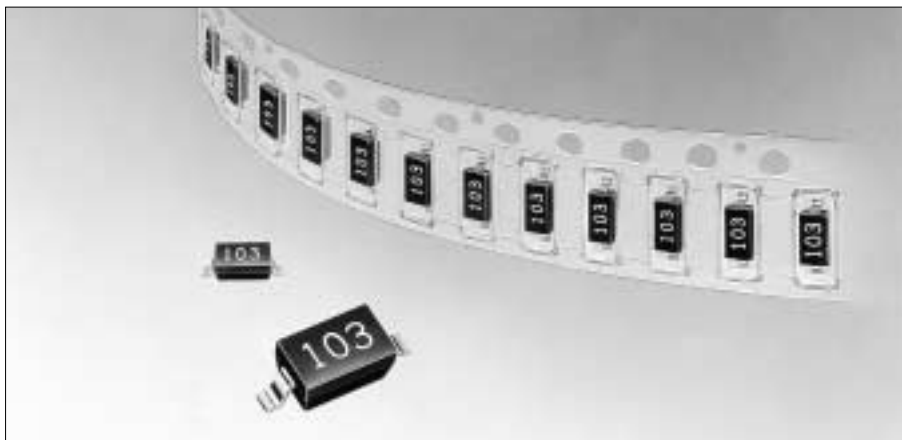

Specifications

Minimum quantity: 3000pcs/reel Unit (mm)

| Part No. | R ₂₅ *1 | B value*2 | Dissipation factor (mW/°C) | Thermal time constant (s)*3 | Rated power at 25°C (mW) | Operating temp. range (°C) |
|----------|-------------------------|-----------------|----------------------------|-----------------------------|--------------------------|----------------------------|
| 302HT(F) | 3.0k $\Omega \pm 2\%$ | 3860K $\pm 1\%$ | 1.0 | 8.0 | 5.0 | -50~125 |
| 502HT(F) | 5.0k $\Omega \pm 2\%$ | 3860K $\pm 1\%$ | 1.0 | 8.0 | 5.0 | -50~125 |
| 103HT(F) | 10.0k $\Omega \pm 2\%$ | 3435K $\pm 1\%$ | 1.0 | 8.0 | 5.0 | -50~100 |
| 203HT(F) | 20.0k $\Omega \pm 2\%$ | 3760K $\pm 1\%$ | 1.0 | 8.0 | 5.0 | -50~125 |
| 303HT(F) | 30.0k $\Omega \pm 2\%$ | 3760K $\pm 1\%$ | 1.0 | 8.0 | 5.0 | -50~125 |
| 503HT(F) | 50.0k $\Omega \pm 2\%$ | 4055K $\pm 1\%$ | 1.0 | 8.0 | 5.0 | -50~125 |
| 104HT(F) | 100.0k $\Omega \pm 2\%$ | 4390K $\pm 1\%$ | 1.0 | 8.0 | 5.0 | -50~125 |

*1 R₂₅: Rated zero-power resistance value at 25°C, $\pm 1\%$ and 3% are also available.

*2 B value: determined by rated zero-power resistance at 25°C and 85°C.

*3 Time when thermistor temperature reaches 63.2% of the temperature difference. The value is measured in the air.

Resistance-Temperature

| Temperature (°C) | Type | | | | | | | | Temperature (°C) | Type | | | | | | | |
|------------------|-------|-------|-------|-------|-------|-------|-------|-------|------------------|--------|--------|--------|-------|-------|-------|--|--|
| | 302HT | 502HT | 103HT | 203HT | 303HT | 503HT | 104HT | 302HT | | 502HT | 103HT | 203HT | 303HT | 503HT | 104HT | | |
| -50 | 182.1 | 303.4 | 367.7 | 1026 | 1539 | 3135 | 9584 | 50 | 1.109 | 1.849 | 4.147 | 7.632 | 11.45 | 17.93 | 32.51 | | |
| -40 | 93.35 | 155.6 | 204.7 | 540.5 | 810.8 | 1602 | 4572 | 60 | 0.7744 | 1.291 | 3.011 | 5.380 | 8.070 | 12.33 | 21.61 | | |
| -30 | 49.85 | 83.09 | 118.5 | 296.7 | 445.1 | 855.0 | 2282 | 70 | 0.5513 | 0.9189 | 2.224 | 3.861 | 5.792 | 8.588 | 14.66 | | |
| -20 | 27.75 | 46.25 | 71.02 | 169.2 | 253.8 | 474.4 | 1191 | 80 | 0.4000 | 0.6667 | 1.668 | 2.815 | 4.223 | 6.064 | 10.13 | | |
| -10 | 16.02 | 26.70 | 43.67 | 99.85 | 149.8 | 272.7 | 647.2 | 90 | 0.2951 | 0.4918 | 1.267 | 2.083 | 3.125 | 4.338 | 7.135 | | |
| 0 | 9.541 | 15.90 | 27.70 | 60.87 | 91.31 | 161.9 | 365.0 | 100 | 0.2210 | 0.3683 | 0.9753 | 1.564 | 2.346 | 3.142 | 5.111 | | |
| 10 | 5.876 | 9.793 | 18.07 | 38.21 | 57.32 | 99.13 | 212.5 | 110 | 0.1680 | 0.2800 | | 1.190 | 1.785 | 2.302 | 3.720 | | |
| 20 | 3.728 | 6.214 | 12.11 | 24.66 | 36.99 | 62.38 | 127.7 | 120 | 0.1295 | 0.2158 | | 0.9159 | 1.374 | 1.705 | 2.746 | | |
| 30 | 2.431 | 4.051 | 8.301 | 16.31 | 24.47 | 40.24 | 78.88 | 125 | 0.1142 | 0.1903 | | 0.8067 | 1.210 | 1.472 | 2.371 | | |
| 40 | 1.623 | 2.705 | 5.811 | 11.04 | 16.56 | 26.58 | 50.03 | | | | | | | | | | |

Unit (k Ω)

THIN FILM TYPE THERMISTOR

[查询"563CT-4"供应商](#)

FT THERMISTOR

The FT thermistors, the highly reliable thermistors, are characterized by their fast response time, which was made possible by the miniaturization of the thermistor dimensions. FT thermistors are also heat-resistant type. FT thermistors are the most excellent products of today's chip thermistors manufacturing.

Part number

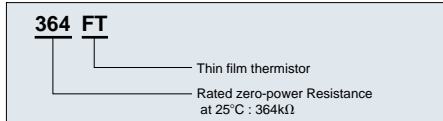

Dimensions

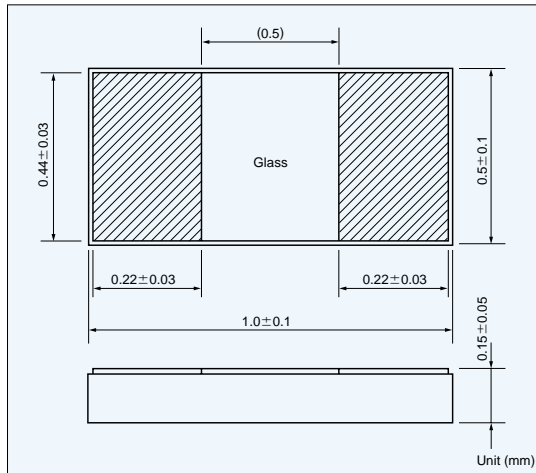

Connect the FTs to the electrodes with using conductive epoxy resins.
The FTs cannot be soldered onto the electrodes.

Specifications

| Part No. | R ₂₅ *1 | B value*2 | Dissipation factor (mW/°C) | Thermal time constant (s)*3 | Rated power at 25°C (mW) | Operating temp. range (°C) |
|----------|--------------------|------------|----------------------------|-----------------------------|--------------------------|----------------------------|
| 103FT | 10kΩ ± 5% | 3435K ± 1% | 0.3 | 2.0 | 1.5 | -20~125 |
| 103FT | 10kΩ ± 5% | 3370K ± 1% | 0.3 | 2.0 | 1.5 | -20~125 |
| 503FT | 50kΩ ± 5% | 3435K ± 1% | 0.3 | 2.0 | 1.5 | -20~125 |
| 503FT | 50kΩ ± 5% | 3370K ± 1% | 0.3 | 2.0 | 1.5 | -20~125 |
| 364FT | 364kΩ ± 5% | 3370K ± 1% | 0.3 | 2.0 | 1.5 | -20~250 |

*1 R₂₅: Rated zero-power resistance value at 25°C.

*2 B value: determined by rated zero-power resistance at 25°C and 85°C.

*3 Time when thermistor temperature reaches 63.2% of the temperature difference. The value is measured in the air.

Resistance-Temperature

| Temperature (°C) | P/N | | | | | Temperature (°C) | P/N | | | | |
|------------------|---------|---------|---------|---------|---------|------------------|---------|---------|---------|---------|---------|
| | 103FT | | 503FT | | 364FT | | 103FT | | 503FT | | 364FT |
| | B=3370K | B=3435K | B=3370K | B=3435K | B=3370K | | B=3370K | B=3435K | B=3370K | B=3435K | B=3370K |
| -20 | 67.26 | 70.34 | 336.3 | 351.9 | 2447 | 120 | | | | | |
| -10 | 42.10 | 43.55 | 210.5 | 217.7 | 1532 | 125 | 0.6345 | 0.6064 | 3.172 | 3.029 | 23.09 |
| 0 | 27.08 | 27.71 | 135.4 | 138.5 | 985.4 | 130 | 0.5671 | 0.5418 | 2.836 | 2.706 | 20.64 |
| 10 | 17.86 | 18.11 | 89.31 | 90.48 | 650.0 | 140 | | | | | 18.50 |
| 20 | 12.07 | 12.12 | 60.33 | 60.58 | 439.1 | 150 | | | | | 14.97 |
| 25 | 10.00 | 10.00 | 50.00 | 50.00 | 363.9 | 160 | | | | | 12.23 |
| 30 | 8.332 | 8.299 | 41.66 | 41.50 | 303.2 | 170 | | | | | 10.07 |
| 40 | 5.871 | 5.804 | 29.36 | 29.03 | 213.7 | 180 | | | | | 8.364 |
| 50 | 4.216 | 4.139 | 21.08 | 20.70 | 153.4 | 190 | | | | | 7.000 |
| 60 | 3.081 | 3.006 | 15.40 | 15.04 | 112.1 | 200 | | | | | 5.901 |
| 70 | 2.288 | 2.220 | 11.44 | 11.11 | 83.25 | 210 | | | | | 5.008 |
| 80 | 1.725 | 1.666 | 8.623 | 8.331 | 62.76 | 220 | | | | | 4.277 |
| 90 | 1.318 | 1.269 | 6.592 | 6.344 | 47.98 | 230 | | | | | 3.676 |
| 100 | 1.021 | 0.9797 | 5.105 | 4.898 | 37.15 | 240 | | | | | 3.177 |
| 110 | 0.8003 | 0.7662 | 4.002 | 3.829 | 29.12 | 250 | | | | | 2.760 |
| | | | | | | | | | | | 2.411 |

Unit (kΩ)

CHIP TYPE THERMISTOR

[查询"563CT-4"供应商](#)

SMD type chip

Chip thermistors are specially processed, highly reliable thermistors.

They can be face-bonded to act as thermal compensators for ICs and they are manufactured in sizes down to 1 square mm, they can also be used to detect temperature with relatively small time constants.

Part number

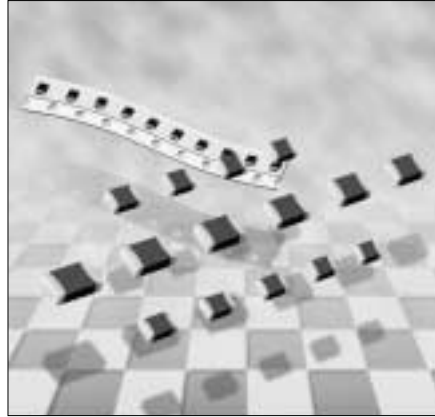
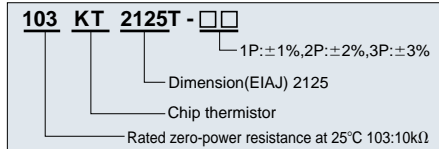

Precautions

- Do not expose the thermistors to high soldering heat for more than specified time. (260°C for not longer than 10s is recommended)

Dimensions

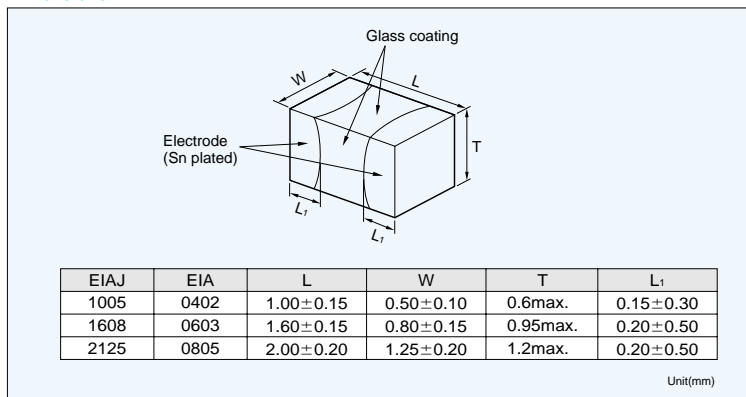

Taping (2125, 1608 type)

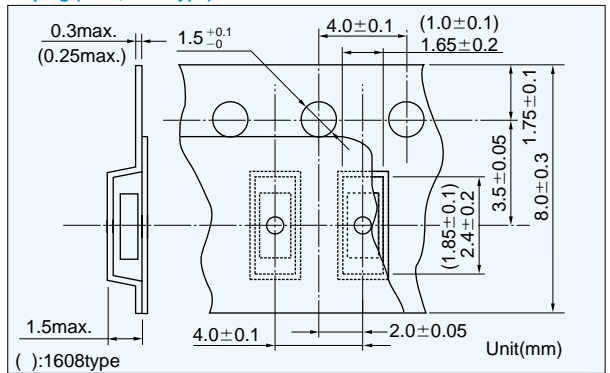

Minimum quantity:4000pcs/reel

(1005 type)

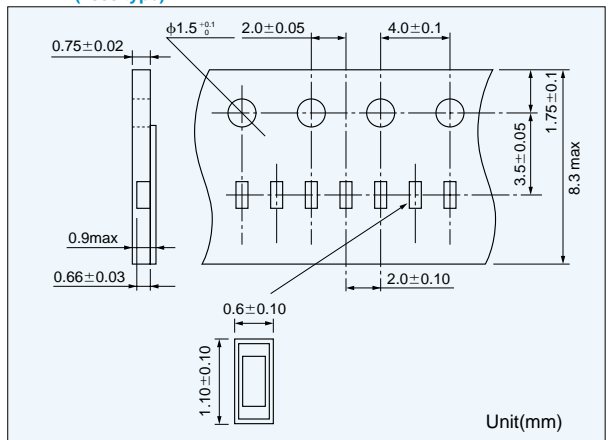

Minimum quantity:10000pcs/reel

Reflow soldering profile

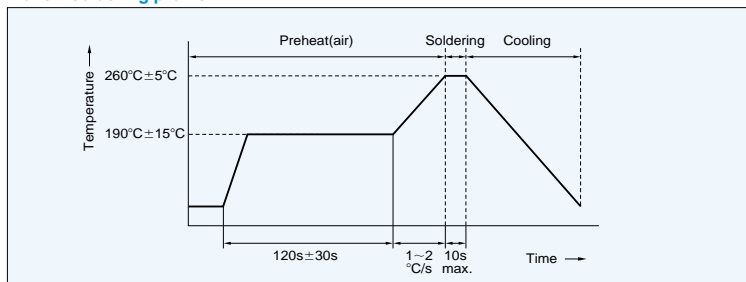

Specifications

| Part No. | R ₂₅ ⁻¹ | B value* ² | Dissipation factor (mW/ °C) | Thermal time constant(s) ^{*3} | Rated power at 25 °C(mW) | Operating temp. range(°C) |
|------------|-------------------------------|-----------------------|-----------------------------|--|--------------------------|----------------------------|
| 103KT2125T | 10kΩ | 3435K±1% | 1.0 | 7.5 | 5.0 | -40~125 |
| 103KT1608T | 10kΩ | 3435K±1% | 0.9 | 5.0 | 4.5 | -40~125 |
| 503KT1608T | 50kΩ | 4055K±1% | 0.9 | 5.0 | 4.5 | -40~125 |
| 104KT1608T | 100kΩ | 4390K±1% | 0.9 | 5.0 | 4.5 | -40~125 |
| 103KT1005T | 10kΩ | 3435K±1% | 0.7 | 2.2 | 3.5 | -40~125 |

*1 R₂₅ : Rated zero-power resistance value at 25°C.

*2 B value : determined by rated zero-power resistance at 25°C and 85°C.

*3 Time when thermistor temperature reaches 63.2% of the temperature difference. The value is measured in the air. Other resistance is available, please ask.

HIGH HEAT-RESISTANCE AND HIGH SENSITIVE THERMISTOR

[查询"563CT-4"供应商](#)

GT THERMISTOR

GT thermistor is combined both superior feature of BT thermistor and ET thermistor as fast response time, high reliability, wide category temperature range, high moisture proof, high accuracy and reasonable price.

GT thermistor is made up of a high quality thermistor element and the lead wire is connected to the thermistor element by alloyed technology, and glass coating for the thermistor element.

Part number

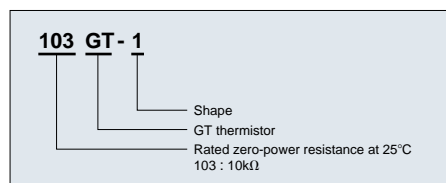

Dimensions

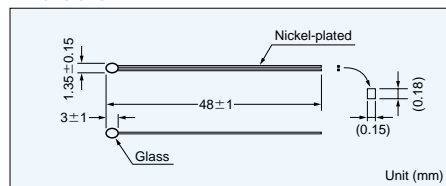

Time constant

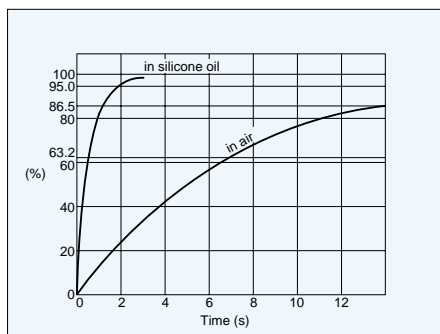

Specifications

| Part No. | R ₂₅ *1 | B value*2 | Dissipation factor (mW/°C) | Thermal time constant(s)*3 | Rated power at 25°C(mW) | Operating temp. range(°C) |
|----------|--------------------|-----------|----------------------------|----------------------------|-------------------------|---------------------------|
| 102GT-1 | 1.0kΩ±3% | 3305K±2% | 0.6 | 7(0.6) | 3 | -50~200 |
| 202GT-1 | 2.0kΩ±3% | 3838K±2% | 0.6 | 7(0.6) | 3 | -50~300 |
| 502GT-1 | 5.0kΩ±3% | 3964K±2% | 0.6 | 7(0.6) | 3 | -50~300 |
| 103GT-1 | 10.0kΩ±3% | 4126K±2% | 0.6 | 7(0.6) | 3 | -50~300 |
| 203GT-1 | 20.0kΩ±3% | 4282K±2% | 0.6 | 7(0.6) | 3 | -50~300 |
| 503GT-1 | 50.0kΩ±3% | 4288K±2% | 0.6 | 7(0.6) | 3 | -50~300 |
| 104GT-1 | 100.0kΩ±3% | 4267K±2% | 0.6 | 7(0.6) | 3 | -50~300 |
| 204GT-1 | 200.0kΩ±3% | 4338K±2% | 0.6 | 7(0.6) | 3 | -50~300 |
| 504GT-1 | 500.0kΩ±3% | 4526K±2% | 0.6 | 7(0.6) | 3 | -50~300 |
| 105GT-1 | 1000.0kΩ±3% | 4608K±2% | 0.6 | 7(0.6) | 3 | -50~300 |

*1 R₂₅: Rated zero-power resistance value at 25°C.

*2 B value: determined by rated zero-power resistance at 25°C and 85°C.

*3 Time when thermistor temperature reaches 63.2% of the temperature difference. The value is measured in the air. (silicone oil)

Resistance-Temperature

| Temperature (°C) | Type | | | | | | | | | | |
|------------------|---------|---------|---------|---------|---------|--------|---------|--------|--------|--------|--|
| | 102GT | 202GT | 502GT | 103GT | 203GT | 503GT | 104GT | 204GT | 504GT | 105GT | |
| -50 | 32.57 | 111.3 | 342.1 | 825.1 | 1901 | 4613 | 8743 | | | | |
| -40 | 18.48 | 61.34 | 175.4 | 405.3 | 909.0 | 2199 | 4218 | 8810 | | | |
| -30 | 10.84 | 33.69 | 92.54 | 206.6 | 453.2 | 1100 | 2132 | 4436 | 12091 | | |
| -20 | 6.594 | 18.79 | 50.44 | 109.9 | 236.6 | 576.2 | 1127 | 2329 | 6268 | | |
| -10 | 4.144 | 10.82 | 28.49 | 60.72 | 128.3 | 315.1 | 620.0 | 1272 | 3372 | 6920 | |
| 0 | 2.675 | 6.424 | 16.66 | 34.82 | 72.32 | 178.8 | 353.7 | 720.3 | 1880 | 3833 | |
| 10 | 1.773 | 3.939 | 10.06 | 20.66 | 42.24 | 104.9 | 208.6 | 421.8 | 1083 | 2190 | |
| 20 | 1.203 | 2.489 | 6.264 | 12.64 | 25.47 | 63.52 | 126.8 | 254.6 | 642.3 | 1289 | |
| 30 | 0.8354 | 1.618 | 4.019 | 7.968 | 15.82 | 39.62 | 79.36 | 158.2 | 391.9 | 780.9 | |
| 40 | 0.5918 | 1.080 | 2.651 | 5.164 | 10.10 | 25.37 | 50.96 | 100.8 | 245.4 | 485.2 | |
| 50 | 0.4273 | 0.7390 | 1.792 | 3.436 | 6.620 | 16.64 | 33.49 | 65.85 | 157.5 | 309.0 | |
| 60 | 0.3141 | 0.5170 | 1.239 | 2.341 | 4.444 | 11.16 | 22.51 | 43.99 | 103.3 | 201.2 | |
| 70 | 0.2347 | 0.3695 | 0.8753 | 1.631 | 3.050 | 7.645 | 15.44 | 29.98 | 69.20 | 133.6 | |
| 80 | 0.1782 | 0.2693 | 0.6304 | 1.159 | 2.138 | 5.338 | 10.80 | 20.82 | 47.23 | 90.53 | |
| 90 | 0.1373 | 0.1998 | 0.4624 | 0.8391 | 1.527 | 3.795 | 7.686 | 14.71 | 32.84 | 62.49 | |
| 100 | 0.1072 | 0.1507 | 0.3450 | 0.6181 | 1.111 | 2.742 | 5.556 | 10.57 | 23.22 | 43.90 | |
| 110 | 0.08483 | 0.1154 | 0.2614 | 0.4626 | 0.8209 | 2.014 | 4.082 | 7.720 | 16.68 | 31.34 | |
| 120 | 0.06787 | 0.08973 | 0.2010 | 0.3514 | 0.6160 | 1.501 | 3.043 | 5.720 | 12.15 | 22.69 | |
| 130 | 0.05488 | 0.07068 | 0.1566 | 0.2706 | 0.4686 | 1.133 | 2.298 | 4.296 | 8.976 | 16.65 | |
| 140 | 0.04483 | 0.05638 | 0.1236 | 0.2111 | 0.3613 | 0.8662 | 1.758 | 3.269 | 6.719 | 12.39 | |
| 150 | 0.03697 | 0.04550 | 0.09865 | 0.1666 | 0.2820 | 0.6704 | 1.360 | 2.516 | 5.091 | 9.330 | |
| 160 | 0.03077 | 0.03715 | 0.07967 | 0.1330 | 0.2226 | 0.5247 | 1.064 | 1.958 | 3.903 | 7.107 | |
| 170 | 0.02584 | 0.03065 | 0.06501 | 0.1073 | 0.1777 | 0.4149 | 0.8414 | 1.539 | 3.024 | 5.472 | |
| 180 | 0.02189 | 0.02556 | 0.05358 | 0.08741 | 0.1432 | 0.3314 | 0.6714 | 1.222 | 2.367 | 4.255 | |
| 190 | 0.01869 | 0.02151 | 0.04457 | 0.07186 | 0.1166 | 0.2673 | 0.5408 | 0.9796 | 1.871 | 3.339 | |
| 200 | 0.01610 | 0.01826 | 0.03741 | 0.05960 | 0.09573 | 0.2174 | 0.4393 | 0.7919 | 1.492 | 2.644 | |
| 210 | | | 0.03167 | 0.04986 | 0.07929 | 0.1784 | 0.3597 | 0.6455 | 1.200 | 2.113 | |
| 220 | | | 0.02703 | 0.04204 | 0.06620 | 0.1475 | 0.2969 | 0.5303 | 0.9726 | 1.702 | |
| 230 | | | 0.02324 | 0.03573 | 0.05570 | 0.1230 | 0.2468 | 0.4389 | 0.7946 | 1.382 | |
| 240 | | | 0.02014 | 0.03059 | 0.04722 | 0.1032 | 0.2065 | 0.3658 | 0.6539 | 1.131 | |
| 250 | | | 0.01759 | 0.02640 | 0.04030 | | 0.1740 | 0.3068 | 0.5418 | 0.9323 | |
| 260 | | | | | | | 0.1475 | 0.2591 | 0.4519 | 0.7735 | |
| 270 | | | | | | | 0.1258 | 0.2201 | 0.3793 | 0.6459 | |
| 280 | | | | | | | 0.1079 | 0.1881 | 0.3203 | 0.5424 | |
| 290 | | | | | | | 0.09305 | 0.1616 | 0.2720 | 0.4583 | |
| 300 | | | | | | | 0.08065 | 0.1396 | 0.2323 | 0.3894 | |

Unit (kΩ)

BT THERMISTOR

The BT thermistor is a small thermal sensing device providing high reliability, stable characteristics and a wide operating range of -50°C to 300°C.

It is used in various applications including medical apparatus, industrial equipment and home electric appliances.

Part number

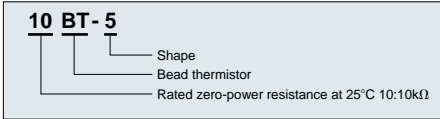

Dimensions

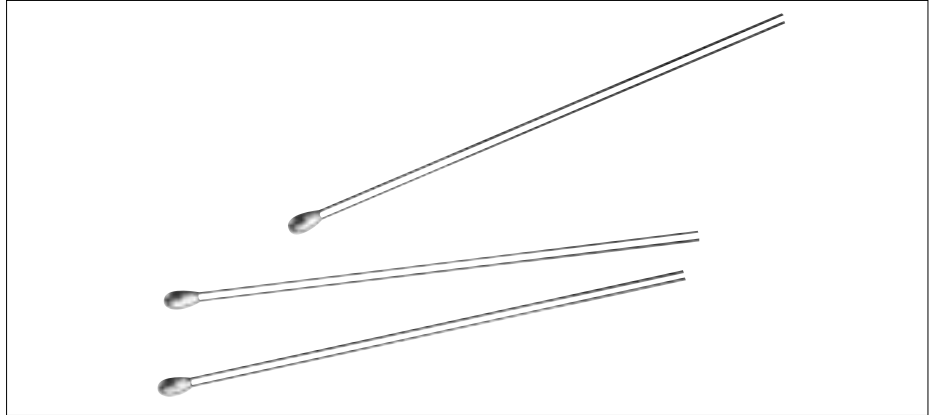
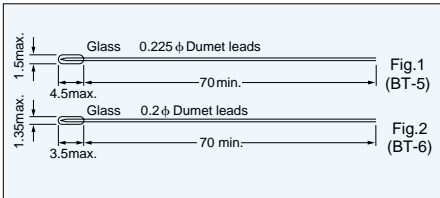

Specifications

| Port No. | R ₂₅ ^{*1} | B value ^{*2} | Dissipation factor (mW/°C) | Thermal Time constant(s) ^{*3} | Rated power at 25°C(mW) | Operating temp. range(°C) |
|-------------|-------------------------------|-----------------------|----------------------------|--|-------------------------|---------------------------|
| 1BT-5 | 1.000kΩ±10% | 3,250K±3% | 0.5 | 4~12 | 2.5 | -50~150 |
| 2BT-5 | 2.000kΩ±10% | 3,420K±3% | 0.5 | 4~12 | 2.5 | -50~300 |
| 5BT-5(6) | 5.000kΩ±10% | 3,450K±3% | 0.5(0.4) | 4~12(3~8) | 2.5(2) | -50~300 |
| 9BT-5(6) | 9.000kΩ±10% | 3,470K±3% | 0.5(0.4) | 4~12(3~8) | 2.5(2) | -50~150 |
| 10BT-5(6) | 10.00kΩ±10% | 3,250K±3% | 0.5(0.4) | 4~12(3~8) | 2.5(2) | -50~300 |
| 20BT-5(6) | 20.00kΩ±10% | 3,330K±3% | 0.5(0.4) | 4~12(3~8) | 2.5(2) | -50~300 |
| 30BT-5(6) | 30.00kΩ±10% | 3,450K±3% | 0.5(0.4) | 4~12(3~8) | 2.5(2) | -50~300 |
| 40BT-5(6) | 40.00kΩ±10% | 3,550K±3% | 0.5(0.4) | 4~12(3~8) | 2.5(2) | -50~300 |
| 100BT-5(6) | 100.0kΩ±10% | 3,750K±3% | 0.5(0.4) | 4~12(3~8) | 2.5(2) | -50~300 |
| 400BT-5(6) | 400.0kΩ±10% | 4,050K±3% | 0.5(0.4) | 4~12(3~8) | 2.5(2) | -50~300 |
| 500BT-5(6) | 500.0kΩ±10% | 3,760K±3% | 0.5(0.4) | 4~12(3~8) | 2.5(2) | -50~300 |
| 1.3MBT-5(6) | 1300kΩ±10% | 4,380K±3% | 0.5(0.4) | 4~12(3~8) | 2.5(2) | -50~300 |

*1 R₂₅: Rated zero-power resistance value at 25°C, ±5% are also available.

*2 B value: determined by rated zero-power resistance at 25°C and 85°C.

*3 Time when thermistor temperature reaches 63.2% of the temperature difference. The value is measured in the air

Resistance-Temperature

| Temperature (°C) | Type | | | | | | | | | | | | |
|------------------|---------|---------|---------|--------|--------|--------|---------|---------|--------|--------|--------|--------|--|
| | 1BT | 2BT | 5BT | 9BT | 10BT | 20BT | 30BT | 40BT | 100BT | 400BT | 500BT | 1.3MBT | |
| -50 | 29.87 | 70.71 | | 344.8 | 284.8 | 686.7 | | | 4860 | | | | |
| -40 | 17.33 | 40.02 | | 190.3 | 163.4 | 383.1 | | | 2599 | 11043 | | | |
| -30 | 10.35 | 23.28 | | 109.1 | 97.62 | 222.6 | | | 1439 | 6198 | | | |
| -20 | 6.374 | 13.96 | 35.44 | 64.81 | 60.41 | 134.2 | | 306.8 | 827.4 | 3573 | | | |
| -10 | 4.038 | 8.640 | 21.84 | 39.70 | 38.63 | 83.61 | | 184.7 | 491.1 | 2109 | | 8066 | |
| 0 | 2.629 | 5.513 | 13.87 | 25.15 | 25.45 | 53.75 | 83.80 | 115.0 | 301.4 | 1274 | 1486 | 4598 | |
| 10 | 1.755 | 3.610 | 9.057 | 16.36 | 17.22 | 35.53 | 54.46 | 73.88 | 190.1 | 788.4 | 945.3 | 2718 | |
| 20 | 1.200 | 2.421 | 6.060 | 10.92 | 11.92 | 24.09 | 36.37 | 48.77 | 123.1 | 498.7 | 614.7 | 1652 | |
| 25 | 1.000 | 2.000 | 5.000 | 9.000 | 10.00 | 20.00 | 30.00 | 40.00 | 100.0 | 400.0 | 500.0 | 1300 | |
| 30 | 0.8380 | 1.661 | 4.148 | 7.456 | 8.434 | 16.70 | 24.88 | 33.00 | 81.71 | 322.4 | 408.9 | 1029 | |
| 40 | 0.5973 | 1.163 | 2.898 | 5.200 | 6.084 | 11.81 | 17.39 | 22.82 | 55.39 | 212.8 | 277.7 | 656.0 | |
| 50 | 0.4338 | 0.8311 | 2.065 | 3.698 | 4.456 | 8.511 | 12.40 | 16.10 | 38.31 | 143.3 | 192.1 | 427.8 | |
| 60 | 0.3205 | 0.6043 | 1.497 | 2.677 | 3.303 | 6.248 | 8.990 | 11.57 | 27.00 | 98.24 | 135.3 | 284.5 | |
| 70 | 0.2407 | 0.4468 | 1.104 | 1.970 | 2.460 | 4.658 | 6.629 | 8.457 | 19.38 | 68.52 | 96.90 | 193.0 | |
| 80 | 0.1834 | 0.3357 | 0.8267 | 1.473 | 1.850 | 3.522 | 4.962 | 6.279 | 14.14 | 48.50 | 70.47 | 133.0 | |
| 90 | 0.1417 | 0.2559 | 0.6280 | 1.117 | 1.405 | 2.698 | 3.767 | 4.730 | 10.48 | 34.91 | 52.00 | 92.76 | |
| 100 | 0.1110 | 0.1978 | 0.4836 | 0.8581 | 1.078 | 2.093 | 2.897 | 3.611 | 7.866 | 25.47 | 38.90 | 65.53 | |
| 110 | 0.08789 | 0.1547 | 0.3771 | 0.6685 | 0.8355 | 1.640 | 2.255 | 2.792 | 5.968 | 18.83 | 29.49 | 46.91 | |
| 120 | | 0.1224 | 0.2975 | 0.5264 | 0.6540 | 1.296 | 1.774 | 2.182 | 4.580 | 14.10 | 22.63 | 34.03 | |
| 130 | | 0.09789 | 0.2373 | 0.4191 | 0.5171 | 1.027 | 1.410 | 1.727 | 3.551 | 10.68 | 17.55 | 25.02 | |
| 140 | | 0.07908 | 0.1913 | 0.3369 | 0.4126 | 0.8190 | 1.130 | 1.378 | 2.782 | 8.180 | 13.76 | 18.59 | |
| 150 | | 0.06450 | 0.1556 | 0.2735 | 0.3321 | 0.6581 | 0.9113 | 1.107 | 2.201 | 6.332 | 10.90 | 13.99 | |
| 160 | | | 0.1278 | | 0.2696 | 0.5327 | 0.7374 | 0.8943 | 1.757 | 4.957 | 8.717 | 10.63 | |
| 170 | | | 0.1058 | | 0.2207 | 0.4345 | 0.5997 | 0.7252 | 1.416 | 3.915 | 7.034 | 8.163 | |
| 180 | | | 0.08836 | | 0.1818 | 0.3567 | 0.4909 | 0.5915 | 1.150 | 3.120 | 5.722 | 6.336 | |
| 190 | | | 0.07432 | | 0.1508 | 0.2947 | 0.4048 | 0.4859 | 0.9418 | 2.508 | 4.692 | 4.965 | |
| 200 | | | 0.06295 | | 0.1258 | 0.2451 | 0.3360 | 0.4018 | 0.7770 | 2.032 | 3.876 | 3.926 | |
| 210 | | | | | 0.1056 | 0.2052 | 0.2808 | 0.3344 | 0.6458 | 1.658 | 3.225 | 3.131 | |
| 220 | | | | | | | 0.2360 | 0.2802 | 0.5403 | 1.363 | 2.702 | 2.517 | |
| 230 | | | | | | | 0.1995 | 0.2361 | 0.4551 | 1.127 | 2.277 | 2.039 | |
| 240 | | | | | | | 0.1695 | 0.2000 | 0.3855 | 0.9390 | 1.930 | 1.663 | |
| 250 | | | | | | | 0.1447 | 0.1704 | 0.3286 | 0.7864 | 1.644 | 1.366 | |
| 260 | | | | | | | 0.1243 | 0.1458 | 0.2816 | 0.6626 | 1.407 | 1.129 | |
| 270 | | | | | | | 0.1072 | 0.1255 | 0.2426 | 0.5613 | 1.209 | 0.9398 | |
| 280 | | | | | | | 0.09283 | 0.1084 | 0.2100 | 0.4780 | 1.041 | 0.7871 | |
| 290 | | | | | | | 0.08078 | 0.09408 | 0.1826 | 0.4091 | 0.8995 | 0.6628 | |
| 300 | | | | | | | 0.07060 | 0.08200 | 0.1595 | 0.3518 | 0.7810 | 0.5612 | |

Unit(kΩ)

CT THERMISTOR

The CT thermistor is a thermal sensor in a DO35 package. Similar to the BT thermistor, it is highly reliable and offers a wide operating range of -50°C to 250°C . It is primarily used in home electric appliances and features a competitive price for full-automated manufacturing system.

Part number

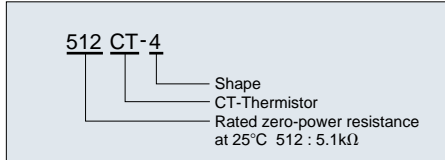

Dimensions

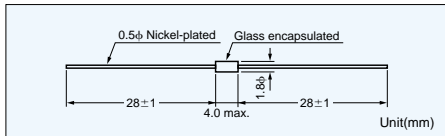

To allow automatic insertion, this product can be taped.



Specifications

| Part No. | R ₂₅ ^{*1} | B value ^{*2} | Dissipation factor (mW/°C) | Thermal time constant (s) ^{*3} | Rated power at 25°C(mW) | Operating temp. range(°C) |
|----------|-------------------------------|-----------------------|----------------------------|---|-------------------------|---------------------------|
| 252CT-4 | 2.5kΩ±5% | 3670K±2% | 2.1 | 10~20 | 10.5 | -50~250 |
| 512CT-4 | 5.1kΩ±5% | 3200K±2% | 2.1 | 10~20 | 10.5 | -50~200 |
| 562CT-4 | 5.6kΩ±5% | 3200K±2% | 2.1 | 10~20 | 10.5 | -50~200 |
| 912CT-4 | 9.1kΩ±5% | 3270K±2% | 2.1 | 10~20 | 10.5 | -50~250 |
| 103CT-4 | 10.0kΩ±5% | 3270K±2% | 2.1 | 10~20 | 10.5 | -50~250 |
| 113CT-4 | 11.0kΩ±5% | 3270K±2% | 2.1 | 10~20 | 10.5 | -50~250 |
| 203CT-4 | 20.0kΩ±5% | 3410K±2% | 2.1 | 10~20 | 10.5 | -50~250 |
| 473CT-4 | 47.0kΩ±5% | 3610K±2% | 2.1 | 10~20 | 10.5 | -50~250 |
| 513CT-4 | 51.0kΩ±5% | 3610K±2% | 2.1 | 10~20 | 10.5 | -50~250 |
| 563CT-4 | 56.0kΩ±5% | 3610K±2% | 2.1 | 10~20 | 10.5 | -50~250 |
| 104CT-4 | 100.0kΩ±5% | 3450K±2% | 2.1 | 10~20 | 10.5 | -50~250 |
| 204CT-4 | 200.0kΩ±5% | 3500K±2% | 2.1 | 10~20 | 10.5 | -50~250 |

*1 R₂₅ : Rated zero-power resistance value at 25°C.

*2 B value : determined by rated zero-power resistance at 25°C and 85°C.

*3 Time when thermistor temperature reaches 63.2% of the temperature difference. The value is measured in the air.

Resistance-Temperature

| Temperature (°C) | Type | | | | | | | | | | | | |
|------------------|---------|---------|---------|---------|---------|---------|---------|--------|--------|--------|--------|-------|--|
| | 252CT | 512CT | 562CT | 912CT | 103CT | 113CT | 203CT | 473CT | 513CT | 563CT | 104CT | 204CT | |
| -50 | 120.2 | 137.9 | 151.4 | | | | | | | | | | |
| -40 | 65.60 | 81.02 | 88.96 | | | | | | | | | | |
| -30 | 36.48 | 48.93 | 53.73 | 94.62 | 104.0 | 114.4 | | | | | | | |
| -20 | 20.91 | 30.56 | 33.55 | 58.02 | 63.76 | 70.13 | | | | | | | |
| -10 | 12.32 | 19.65 | 21.58 | 36.67 | 40.29 | 44.32 | 81.00 | | | | | | |
| 0 | 7.516 | 12.96 | 14.23 | 23.82 | 26.18 | 28.79 | 52.63 | 127.1 | 138.0 | 151.5 | 272.2 | 553.6 | |
| 10 | 4.738 | 8.779 | 9.639 | 15.92 | 17.49 | 19.24 | 35.15 | 84.16 | 91.32 | 100.3 | 179.4 | 362.5 | |
| 20 | 3.074 | 6.080 | 6.676 | 10.91 | 11.99 | 13.18 | 24.01 | 56.86 | 61.70 | 67.75 | 120.9 | 242.5 | |
| 30 | 2.045 | 4.296 | 4.717 | 7.626 | 8.381 | 9.219 | 16.74 | 39.01 | 42.33 | 46.47 | 83.11 | 165.7 | |
| 40 | 1.393 | 3.095 | 3.398 | 5.441 | 5.980 | 6.578 | 11.88 | 27.07 | 29.37 | 32.25 | 58.23 | 115.3 | |
| 50 | 0.9698 | 2.267 | 2.489 | 3.952 | 4.342 | 4.777 | 8.570 | 19.05 | 20.67 | 22.70 | 41.52 | 81.91 | |
| 60 | 0.6895 | 1.687 | 1.852 | 2.918 | 3.206 | 3.527 | 6.239 | 13.58 | 14.74 | 16.18 | 30.14 | 59.14 | |
| 70 | 0.4993 | 1.270 | 1.394 | 2.184 | 2.400 | 2.640 | 4.581 | 9.807 | 10.64 | 11.68 | 22.19 | 43.36 | |
| 80 | 0.3680 | 0.9650 | 1.060 | 1.656 | 1.820 | 2.002 | 3.401 | 7.187 | 7.798 | 8.559 | 16.57 | 32.28 | |
| 90 | 0.2757 | 0.7402 | 0.8128 | 1.269 | 1.394 | 1.534 | 2.553 | 5.327 | 5.781 | 6.348 | 12.52 | 24.33 | |
| 100 | 0.2098 | 0.5735 | 0.6298 | 0.9787 | 1.076 | 1.183 | 1.937 | 3.997 | 4.337 | 4.762 | 9.586 | 18.57 | |
| 110 | 0.1620 | 0.4493 | 0.4933 | 0.7605 | 0.8357 | 0.9193 | 1.489 | 3.040 | 3.298 | 3.622 | 7.434 | 14.36 | |
| 120 | 0.1267 | 0.3559 | 0.3908 | 0.5952 | 0.6540 | 0.7194 | 1.156 | 2.337 | 2.535 | 2.784 | 5.827 | 11.24 | |
| 130 | 0.1003 | 0.2847 | 0.3126 | 0.4702 | 0.5168 | 0.5684 | 0.9075 | 1.815 | 1.969 | 2.162 | 4.619 | 8.900 | |
| 140 | 0.08028 | 0.2298 | 0.2524 | 0.3750 | 0.4121 | 0.4533 | 0.7191 | 1.425 | 1.546 | 1.698 | 3.694 | 7.108 | |
| 150 | 0.06494 | 0.1870 | 0.2053 | 0.3016 | 0.3314 | 0.3646 | 0.5752 | 1.129 | 1.226 | 1.346 | 2.982 | 5.732 | |
| 160 | 0.05302 | 0.1534 | 0.1684 | 0.2444 | 0.2686 | 0.2955 | 0.4638 | 0.9031 | 0.9799 | 1.076 | 2.428 | 4.666 | |
| 170 | 0.04369 | 0.1267 | 0.1391 | 0.1996 | 0.2193 | 0.2413 | 0.3771 | 0.7280 | 0.7899 | 0.8674 | 1.992 | 3.829 | |
| 180 | 0.03630 | 0.1055 | 0.1158 | 0.1643 | 0.1805 | 0.1986 | 0.3091 | 0.5919 | 0.6422 | 0.7052 | 1.647 | 3.168 | |
| 190 | 0.03039 | 0.08833 | 0.09699 | 0.1362 | 0.1496 | 0.1646 | 0.2552 | 0.4849 | 0.5261 | 0.5777 | 1.371 | 2.641 | |
| 200 | 0.02562 | 0.07445 | 0.08175 | 0.1136 | 0.1249 | 0.1374 | 0.2122 | 0.4000 | 0.4341 | 0.4766 | 1.149 | 2.216 | |
| 210 | | | | 0.09541 | 0.1049 | 0.1153 | 0.1777 | 0.3324 | 0.3607 | 0.3961 | 0.9697 | 1.871 | |
| 220 | | | | 0.08063 | 0.08860 | 0.09746 | 0.1497 | 0.2780 | 0.3016 | 0.3312 | 0.8235 | 1.591 | |
| 230 | | | | 0.06853 | 0.07531 | 0.08284 | 0.1269 | 0.2339 | 0.2538 | 0.2787 | 0.7033 | 1.360 | |
| 240 | | | | 0.05857 | 0.06436 | 0.07080 | 0.1082 | 0.1979 | 0.2147 | 0.2358 | 0.6038 | 1.169 | |
| 250 | | | | 0.05031 | 0.05529 | 0.06082 | 0.09271 | 0.1683 | 0.1827 | 0.2006 | 0.5208 | 1.010 | |

Unit(kΩ)

TEMPERATURE COMPENSATION D THERMISTOR

The D thermistor, based on resistance changes, is used in transistor, coil and other temperature compensating circuits found in TV's, radio, etc.

Part number

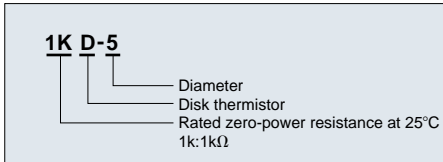

Dimensions

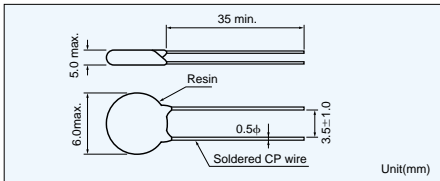

Taping

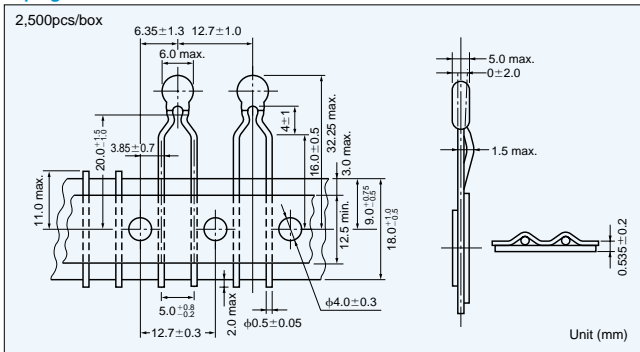

Specifications

| Part No. | R25*1 | B value*2 | Dissipation factor (mW/°C) | Thermal time constant(s)*3 | Rated power at 25°C(mW) | Operating temp. range(°C) |
|----------|---------------|------------|----------------------------|----------------------------|-------------------------|---------------------------|
| 50D-5 | 50.0Ω ± 15% | 3250K ± 5% | 3.5 | 13 | 297 | -40 ~ +110 |
| 80D-5 | 80.0Ω ± 15% | 3300K ± 5% | 3.5 | 13 | 297 | -40 ~ +110 |
| 100D-5 | 100.0Ω ± 15% | 3300K ± 5% | 3.5 | 13 | 297 | -40 ~ +110 |
| 200D-5 | 200.0Ω ± 15% | 3400K ± 5% | 3.5 | 13 | 297 | -40 ~ +110 |
| 250D-5 | 250.0Ω ± 15% | 3450K ± 5% | 3.5 | 13 | 297 | -40 ~ +110 |
| 300D-5 | 300.0Ω ± 15% | 3500K ± 5% | 3.5 | 13 | 297 | -40 ~ +110 |
| 360D-5 | 360.0Ω ± 15% | 3550K ± 5% | 3.5 | 13 | 297 | -40 ~ +110 |
| 500D-5 | 500.0Ω ± 15% | 3650K ± 5% | 3.5 | 13 | 297 | -40 ~ +110 |
| 800D-5 | 800.0Ω ± 15% | 3850K ± 5% | 3.5 | 13 | 297 | -40 ~ +110 |
| 1KD-5 | 1.0kΩ ± 15% | 3950K ± 5% | 3.5 | 13 | 297 | -40 ~ +110 |
| 1.5KD-5 | 1.5kΩ ± 15% | 3950K ± 5% | 3.5 | 13 | 297 | -40 ~ +110 |
| 2KD-5 | 2.0kΩ ± 15% | 4000K ± 5% | 3.5 | 13 | 297 | -40 ~ +110 |
| 5KD-5 | 5.0kΩ ± 15% | 4100K ± 5% | 3.5 | 13 | 297 | -40 ~ +110 |
| 8KD-5 | 8.0kΩ ± 15% | 4200K ± 5% | 3.5 | 13 | 297 | -40 ~ +110 |
| 10KD-5 | 10.0kΩ ± 15% | 4200K ± 5% | 3.5 | 13 | 297 | -40 ~ +110 |
| 15KD-5 | 15.0kΩ ± 15% | 4250K ± 5% | 3.5 | 13 | 297 | -40 ~ +110 |
| 20KD-5 | 20.0kΩ ± 15% | 4300K ± 5% | 3.5 | 13 | 297 | -40 ~ +110 |
| 25KD-5 | 25.0kΩ ± 15% | 4300K ± 5% | 3.5 | 13 | 297 | -40 ~ +110 |
| 50KD-5 | 50.0kΩ ± 15% | 4650K ± 5% | 3.5 | 13 | 297 | -40 ~ +110 |
| 100KD-5 | 100.0kΩ ± 15% | 4850K ± 5% | 3.5 | 13 | 297 | -40 ~ +110 |

*1 R25 : Rated zero-power resistance value at 25°C, ±10% are also available.

*2 B value : determined by rated zero-power resistance at 25°C and 85°C.

*3 Time when thermistor temperature reaches 63.2% of the temperature difference. The value is measured in the air.

FROST DETECTING SENSOR FD SENSOR

The FD Sensor has been developed to detect the level of accumulated frost on the evaporator in frost-free systems, such as those found in domestic fridge-freezers. It helps to eliminate unnecessary defrost cycles and also increases the energy efficiency of the system.

1. Application

Any frost-free system found in domestic and commercial fridge-freezers, vending machines, ice-makers, etc.

2. Features

- Simple detecting principle
- Highly sensitive
- Ease of assembly
- Replaces less-efficient conventional sensors

3. Dimensions

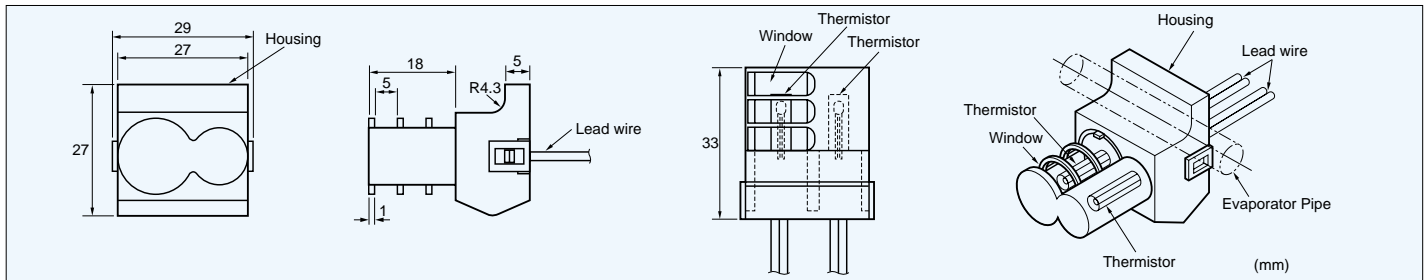

4. Findings from studies carried on the FD Sensor

Study (A)

A 12% of energy saving in a 420 liter domestic frost-free fridge-freezer was found by one of the major Japanese refrigerator manufacturers by the following test procedures.

Test Procedure

The power consumption measurement was carried out in accordance with "JIS C9607 power consumption test, item B (≡ISO8561). The test procedure was extended to one week to determine the full advantage of the defrost system using the FD Sensor.

| | Power Consumption | No. of defrost cycle completed |
|---------------------------------------|-------------------|--------------------------------|
| Conventional Fixedtime defrost system | 74.16KK Whr/month | 9 times/week |
| Defeost system with FD Sensor | 65.6KK Whr/month | Once/week |
| Improved efficiency | | 12% |

Study (B)

Evaluation of the FD Sensor in a 130 liter domestic frost-free fridge-freezer was made by another Japanese refrigerator manufacturer. They obtained an energy saving of over 10% using the same test method as in 5(A) above but including the opening and closing the fridge-freezers doors.

Study (C)

Evaluation of the FD Sensor in a 400 liter domestic frost-free fridge-freezer made by a Japanese refrigerator manufacturer shows an energy saving of over 10%. Measurement of this energy saving was made using the test method specified as in 5(A) above.

5. Specifications

FD Sensor

- 1) Environmental Temperature range : $-40^{\circ}\text{C} \sim +80^{\circ}\text{C}$
- 2) Operating temperature range : $-40^{\circ}\text{C} \sim -5^{\circ}\text{C}$
- 3) Sensitivity : $4^{\circ}\text{C} \sim 12^{\circ}\text{C}$

(Difference in temperature measured by both NTC Thermistors when no frost is recognized.)

NTC Thermistor characteristics(only for reference)

- 1) Nominal Zero power resistance : $R_{25}=10\text{k}\Omega \pm 3\%$
- 2) Rated B value : $B_{25/85}=3435\text{K} \pm 1\%$
- 3) Absolute difference between the two NTCs : $\pm 0.2\%$ or $\pm 0.05^{\circ}\text{C}$ at 25°C

6. Reliability

Climatic test properties

| Test | Test Conditions | Criteria |
|---------------|--|---|
| Dry heat | In air at 100°C for 1,000hr. | Deviation of resistance at 25°C from the original value after test within $\pm 2\%$ and deviation of B value(B25/85) from the original value after test is within $\pm 1\%$. |
| Cold | In air at -55°C for 1,000hr. | |
| Damp heat | 95% RH at 40°C for 1,000hr. | |
| Thermal shock | Between -40°C and $+75^{\circ}\text{C}$ for 10,000 cycles. | |

7. Mechanical properties

| Test | Test Conditions | Criteria |
|---------------------------|---------------------------------|---|
| Free Fall | 3 natural drops from 75 cm high | Deviation of resistance at 25°C from the original value after test within $\pm 2\%$ and deviation of B value(B25/85) from the original value after test is within $\pm 1\%$. |
| Robustness of termination | 40 N for 10 seconds | |
| Vibration | JIS C2571 Item A | |

POWER THERMISTOR

The POWER THERMISTOR is a device for suppressing inrush current to an electric circuit. Circuits including electric bulbs or capacitors induce an inrush current more than 100 times the normal current when the circuit switch is turned on. The POWER THERMISTOR in the circuits protects electric equipments from being damaged by limiting the inrush current.

MARK II is a NEW POWER THERMISTOR featuring smaller size and larger energy capacity to meet severe requirements in inrush current suppression. There is the tendency of miniaturization in low power switching power supply, and MARK II is effectively applicable for the needs, though the comparatively larger sized fixed resistors (ceramic coat) are used now.



Application

The power thermistor will suppress inrush current which is caused by a capacitor, filament for a bulb, inverter for fluorescent lamp, a heater and etc., also will control fan motor speed of cooler for electric circuit. Especially MARK II was developed to use for power supply of TV, VCR instead of cement resistor.

How to use the power thermistor

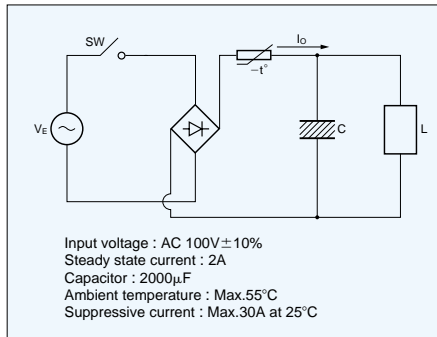

Accordingly, suitable thermistors are 6D-22, 5D-18 and 8D-18, and if we consider in the points of small time constant which means a small size and large effect for suppressive current which means large rated zero-power resistance, 8D-18 is the most suitable one.

Use the following circuit in the power supply for 100V and 200V.

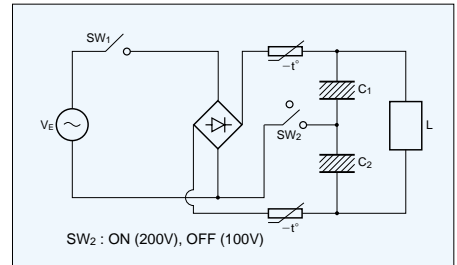

The most suitable power thermistor for the above circuit is required to fulfill the following terms and conditions.

1. The permissible current at ambient temperature of 55°C should be over 2A.
2. The thermistor resistance for suppressive current which becomes below 30A should be over 4.2 ohm from the under-mentioned formula.

$$\frac{\sqrt{2} V_E \times 1.1}{R_C + R_{25}} \leq 30$$

R_C : Internal resistance value in the circuit is 1 ohm (100V/100A)

R₂₅ : Rated zero-power resistance at 25°C

3. Max. capacitance shall be over 2000μF at AC 100V.

Thermal time constant

If ambient temperature of a thermistor is changed to T_1 from T_2 suddenly, temperature of the thermistor changes slowly. The time constant means the time when temperature of the thermistor reaches 63% of the temperature difference.

Residual resistance

If current is flowed through a thermistor, any heat will be generated in the thermistor by which its resistance will be decreased, however, a decrease of a resistance will be stabilized at a saturation resistance value which is determined by impressed electric power and a dissipation constant. The residual resistance value means maximum saturation resistance value when the maximum permissible current is flowed through the thermistor.

Temperature coefficient

The temperature coefficient of a thermistor is expressed by the following equation ;

$$-\frac{B}{T^2} \text{ (%/}^\circ\text{C)}$$

Dissipation factor

If small voltage is applied to a thermistor, small current will flow which produce enough heat in the thermistor. Dissipation factor is electric power which make 1°C raise by heat in a thermistor.

$$\delta = \frac{P}{\Delta t} \text{ (mW/}^\circ\text{C)}$$

P is applied electric power.
 Δt is rised temperature of the thermistor.

Maximum permissible current

If the maximum permissible current flows to a thermistor at 25°C , temperature of the thermistor rises to 200°C , (160°C). When ambient temperature is above 25°C , the maximum permissible current shall be over reduced as the maximum permissible current reduction curve.

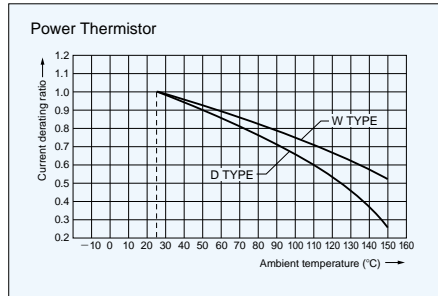
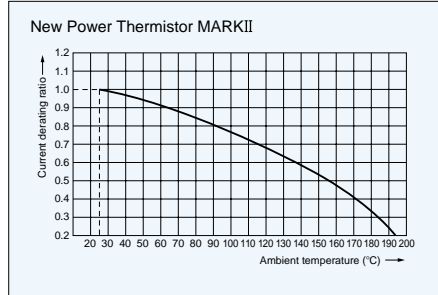

Reliability tests

MARKII

Dry heat test

Test sample is exposed in air at 200°C for 1,000 hours. $\Delta R_{25}/R_{25} \leq \pm 20\%$

Damp heat test

Test sample is exposed in atmosphere of 95%RH at 40°C for 1,000 hours. $\Delta R_{25}/R_{25} \leq \pm 10\%$

Load test

Test sample is applied the maximum rating current in air at 25°C for 1,000 hours. $\Delta R_{25}/R_{25} \leq \pm 20\%$

Change of temperature

Test sample is given 10 times of the following temperature cycle,
 $\rightarrow -40^\circ\text{C}$ for 30 minutes \rightarrow room temperature for 5 minutes \rightarrow
 $\rightarrow 200^\circ\text{C}$ for 30 minutes \rightarrow room temperature for 5 minutes.
 $\Delta R_{25}/R_{25} \leq \pm 10\%$

POWER THERMISTOR

Dry heat test

Test sample is exposed in air at 160°C for 1,000 hours. $\Delta R_{25}/R_{25} \leq \pm 10\%$

Damp heat test

Test sample is exposed in atmosphere of 95%RH at 40°C for 1,000 hours. $\Delta R_{25}/R_{25} \leq \pm 10\%$

Load test

Test sample is applied the maximum rating current in air at 25°C for 1,000 hours. $\Delta R_{25}/R_{25} \leq \pm 10\%$

Change of temperature

Test sample is given 10 times of the following temperature cycle,
 $\rightarrow -30^\circ\text{C}$ for 30 minutes \rightarrow room temperature for 5 minutes \rightarrow
 $\rightarrow 160^\circ\text{C}$ for 30 minutes \rightarrow room temperature for 5 minutes.
 $\Delta R_{25}/R_{25} \leq \pm 10\%$

Resistance-temperature characteristics

The theoretical characteristics of a thermistor is expressed by following equation.

$$R_1 = R_2 \exp \left\{ B \left(\frac{1}{T_1} - \frac{1}{T_2} \right) \right\}$$

R_1 is the zero-power resistance at absolute temperature T_1
 R_2 is the zero-power resistance at absolute temperature T_2

B is constant which depends on the material used to make the thermistor. Unless otherwise specified, all values of B are determined from measurements made at 25°C and 85°C .

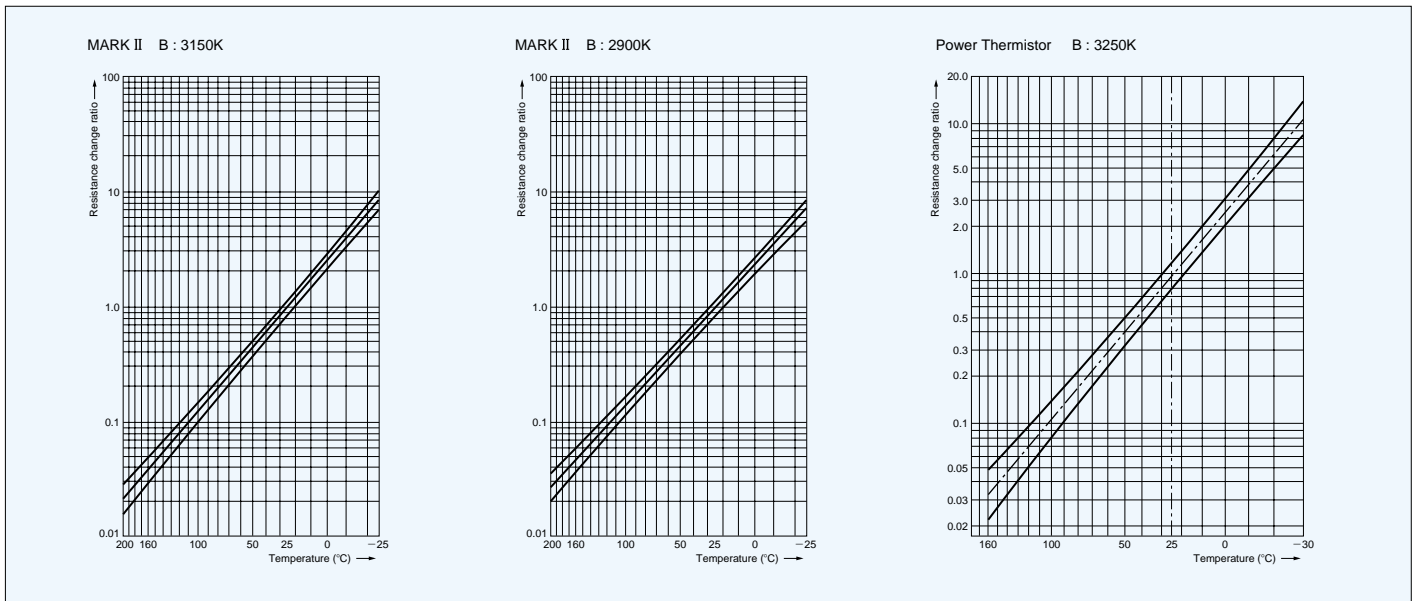



Specifications (Disk type)

| Part No. | R ₂₅ ^{*1} (Ω) | B value ^{*2} B _{25/85} (K) | Maximum energy J (W·s) | Maximum rating current at 25°C (A) | Residual resistance (Ω) | Dissipation factor (mW/°C) | Thermal time constant ^{*4} (s) | Rating temp (°C) | Maximum capacitance (μF) | | | |
|----------|--------------------------------------|--|------------------------------|---|-------------------------------|----------------------------------|--|------------------------|-----------------------------|--------|--------|--------|
| | | | | | | | | | AC100V | AC120V | AC220V | AC240V |
| 3D-22 | 3±15% | 3250±5% | 40.0 | 5.4 | 0.137 | 29.8 | 130 | -30~160 | 8,500 | 5,900 | 1,700 | 1,470 |
| 4D-22 | 4±15% | 3250±5% | 50.0 | 4.7 | 0.182 | 30.7 | 160 | -30~160 | 11,000 | 7,600 | 2,200 | 1,900 |
| 6D-22 | 6±15% | 3250±5% | 80.0 | 3.9 | 0.274 | 32.4 | 220 | -30~160 | 17,000 | 11,800 | 3,500 | 2,950 |
| 4D-18 | 4±15% | 3250±5% | 9.0 | 4.1 | 0.182 | 22.8 | 100 | -30~160 | 2,000 | 1,350 | 410 | 340 |
| 5D-18 | 5±15% | 3250±5% | 11.0 | 3.8 | 0.228 | 24.6 | 120 | -30~160 | 2,500 | 1,700 | 510 | 430 |
| 8D-18 | 8±15% | 3250±5% | 18.0 | 3.1 | 0.365 | 27.2 | 150 | -30~160 | 4,100 | 2,800 | 840 | 710 |
| 10D-18 | 10±15% | 3250±5% | 22.0 | 2.8 | 0.456 | 28.2 | 150 | -30~160 | 5,000 | 3,400 | 1,030 | 860 |
| 5D-13 | 5±15% | 3250±5% | 4.0 | 3.4 | 0.228 | 20.1 | 55 | -30~160 | 900 | 620 | 180 | 150 |
| 8D-13 | 8±15% | 3250±5% | 6.0 | 2.7 | 0.365 | 20.3 | 65 | -30~160 | 1,400 | 970 | 280 | 240 |
| 16D-13 | 16±15% | 3250±5% | 12.0 | 1.9 | 0.730 | 21.4 | 105 | -30~160 | 2,800 | 1,900 | 570 | 480 |
| 5D-11 | 5±15% | 3250±5% | 4.0 | 3.3 | 0.228 | 19.0 | 50 | -30~160 | 900 | 620 | 180 | 150 |
| 8D-11 | 8±15% | 3250±5% | 6.0 | 2.6 | 0.365 | 19.8 | 70 | -30~160 | 1,400 | 970 | 280 | 240 |
| 10D-11 | 10±15% | 3250±5% | 7.0 | 2.4 | 0.456 | 20.1 | 75 | -30~160 | 1,800 | 1,250 | 370 | 310 |
| 10D-9 | 10±15% | 3250±5% | 2.0 | 2.2 | 0.456 | 17.2 | 40 | -30~160 | 510 | 350 | 100 | 80 |
| 16D-9 | 16±15% | 3250±5% | 4.0 | 1.7 | 0.730 | 17.4 | 50 | -30~160 | 820 | 560 | 160 | 140 |
| 22D-7 | 22±15% | 3250±5% | 1.0 | 1.4 | 1.003 | 15.7 | 30 | -30~160 | 310 | 210 | 60 | 50 |

Specifications (Washer type)

| Part No. | R ₂₅ ^{*1} (Ω) | B value ^{*2} B _{25/85} (K) | Maximum energy J (W·s) | Maximum rating current at 25°C (A) | Residual resistance (Ω) | Dissipation factor (mW/°C) | Thermal time constant ^{*4} (s) | Rating temp (°C) | Maximum capacitance (μF) | | | |
|----------|--------------------------------------|--|------------------------------|---|-------------------------------|----------------------------------|--|------------------------|-----------------------------|--------|--------|--------|
| | | | | | | | | | AC100V | AC120V | AC220V | AC240V |
| 6W-22 | 6.0±15% | 3250±5% | 80 | 6.1 | 0.153 | 34.0 | 220 | -30~200 | 17,000 | 11,800 | 3,500 | 2,950 |
| 4W-25 | 4.0±15% | 3250±5% | 50 | 7.8 | 0.102 | 36.2 | 160 | -30~200 | 11,000 | 7,600 | 2,200 | 1,900 |

*1 R₂₅: Rated zero-power resistance value at 25°C.
 *2 B value: determined by rated zero-power resistance at 25°C and 85°C.
 *3 Residual resistance is the maximum value when maximum rating current is applied.
 *4 Time when thermistor temperature reaches 63.2% of the temperature difference. The value is measured in the air.

Part number

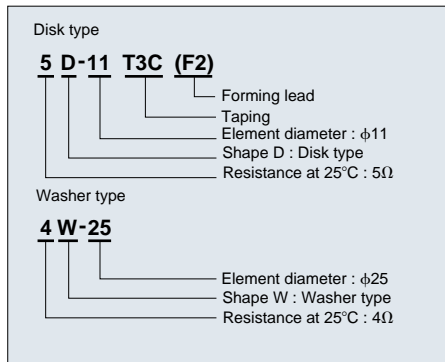

Dimensions

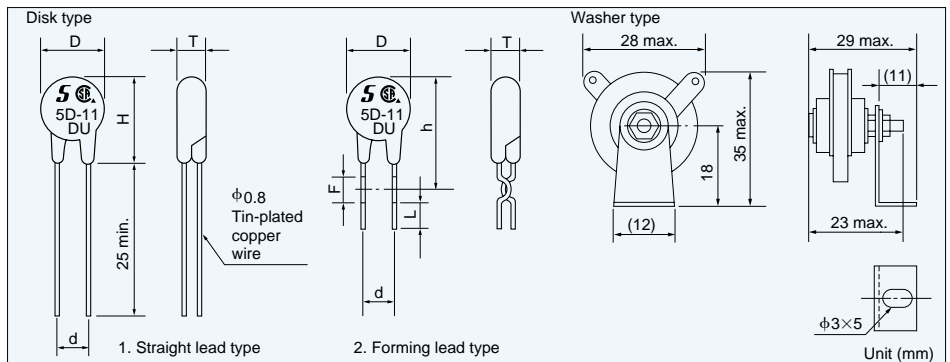

- UL approved (Disk type)
 File No. E92669
 Thermistor type device
- Canadian Standards (Disk type)
 File No. CA97673-1
 Class 7950 30 NTC Thermistor

| | D | T | H | h | F | L | d |
|------|---------|-------|--------|--------|-------|---------|-------|
| D-7 | 9.5max. | 5max. | 13max. | 15max. | 3±0.2 | 3.5±0.5 | 6±1 |
| D-9 | 11max. | 6max. | 15max. | 17max. | | | 7.5±1 |
| D-11 | 14max. | | 18max. | 20max. | | | |
| D-13 | 16max. | 8max. | 20max. | 22max. | | | 10±1 |
| D-18 | 21max. | 9max. | 26max. | 28max. | | | |
| D-22 | 25max. | 8max. | 30max. | 32max. | | | |

Taping

| | P | P ₀ | P ₁ | W | W ₀ | W ₁ | W ₂ | H ₁ | L | F ₁ | φD ₀ | t | t ₁ | Δh |
|------|------|----------------|----------------|------------------------------------|----------------|----------------|----------------|----------------|-------|----------------|-----------------|---------|----------------|-----|
| D-7 | 15±1 | 15±0.3 | 3.75±0.7 | 18 ^{+1.0} _{-0.5} | 5min. | 9±0.5 | 3max. | 16±0.5 | 1max. | 7.5±0.5 | 4±0.3 | 0.6±0.3 | 1.6max. | 0±2 |
| D-9 | | | | | | | | | | | | | | |
| D-11 | | | | | | | | | | | | | | |
| D-13 | 30±1 | | | | | | | | | | | | | |

Taping

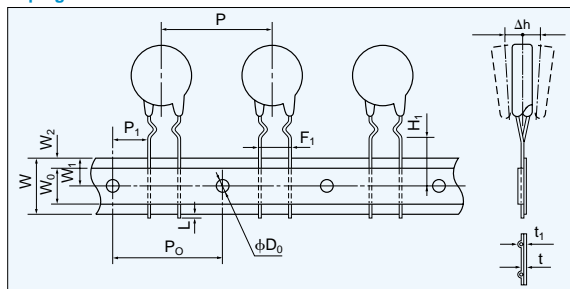



Specifications (Disk type)

| Part No. | R ₂₅ ^{*1} (Ω) | B value ^{*2} B _{25/85} (K) | Maximum energy J (W·s) | Maximum rating current at 25°C (A) | Residual resistance (Ω) | Dissipation factor (mW/°C) | Thermal time constant (s) | Rating temp (°C) | Maximum capacitance (μF) | | | |
|----------|--------------------------------------|--|------------------------------|---|-------------------------------|----------------------------------|------------------------------------|------------------------|-----------------------------|--------|--------|--------|
| | | | | | | | | | AC100V | AC120V | AC220V | AC240V |
| M5R107 | 5.1±10% | 2900±5% | 2.0 | 4.6 | 0.18 | 17.0 | 20 | -40~200 | 400 | 270 | 80 | 60 |
| M8R207 | 8.2±10% | 2900±5% | 2.8 | 3.6 | 0.30 | 17.2 | 25 | -40~200 | 560 | 380 | 110 | 90 |
| M10007 | 10.0±10% | 2900±5% | 3.4 | 3.3 | 0.36 | 17.2 | 30 | -40~200 | 680 | 470 | 140 | 110 |
| M12007 | 12.0±10% | 3150±5% | 3.6 | 3.6 | 0.24 | 17.5 | 25 | -40~200 | 560 | 380 | 110 | 90 |
| M16007 | 16.0±10% | 3150±5% | 4.0 | 3.1 | 0.43 | 17.8 | 30 | -40~200 | 800 | 550 | 160 | 130 |
| M22007 | 22.0±10% | 3150±5% | 4.8 | 2.6 | 0.59 | 18.0 | 40 | -40~200 | 960 | 660 | 190 | 160 |
| M2R210 | 2.2±10% | 2900±5% | 8.2 | 7.4 | 0.08 | 18.9 | 40 | -40~200 | 1,640 | 1,130 | 330 | 280 |
| M3R010 | 3.0±10% | 2900±5% | 8.6 | 6.4 | 0.11 | 19.2 | 45 | -40~200 | 1,720 | 1,190 | 350 | 290 |
| M3R910 | 3.9±10% | 2900±5% | 8.0 | 5.6 | 0.11 | 19.5 | 45 | -40~200 | 1,880 | 1,300 | 380 | 320 |
| M5R110 | 5.1±10% | 3150±5% | 7.2 | 5.7 | 0.14 | 19.2 | 40 | -40~200 | 1,440 | 1,000 | 290 | 250 |
| M8R210 | 8.2±10% | 3150±5% | 7.8 | 4.5 | 0.22 | 19.9 | 50 | -40~200 | 1,560 | 1,080 | 320 | 270 |
| M10010 | 10.0±10% | 3150±5% | 8.2 | 4.1 | 0.27 | 20.1 | 60 | -40~200 | 1,640 | 1,130 | 330 | 280 |
| M1R014 | 1.0±10% | 2900±5% | 18.0 | 11.9 | 0.04 | 22.0 | 65 | -40~200 | 3,720 | 2,580 | 760 | 640 |
| M2R014 | 2.0±10% | 2900±5% | 21.0 | 8.6 | 0.07 | 23.4 | 90 | -40~200 | 4,200 | 2,900 | 860 | 720 |
| M3R014 | 3.0±10% | 3150±5% | 15.0 | 8.3 | 0.08 | 23.6 | 80 | -40~200 | 3,080 | 2,130 | 630 | 530 |
| M3R914 | 3.9±10% | 3150±5% | 17.0 | 7.4 | 0.08 | 24.5 | 95 | -40~200 | 3,400 | 2,360 | 700 | 590 |
| M5R114 | 5.1±10% | 3150±5% | 18.0 | 6.5 | 0.14 | 24.7 | 110 | -40~200 | 3,600 | 2,500 | 740 | 620 |

*1 R₂₅: Rated zero-power resistance value at 25°C.
 *2 B value: determined by rated zero-power resistance at 25°C and 85°C.
 *3 Residual resistance is the maximum value when maximum rating current is applied.
 *4 Time when thermistor temperature reaches 63.2% of the temperature difference. The value is measured in the air.

Part number

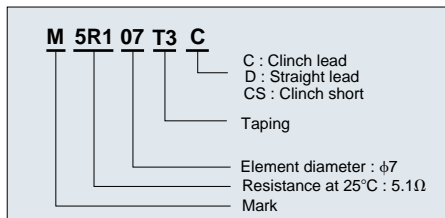

●UL approved File No. E92669 Thermistor type devices

Dimensions

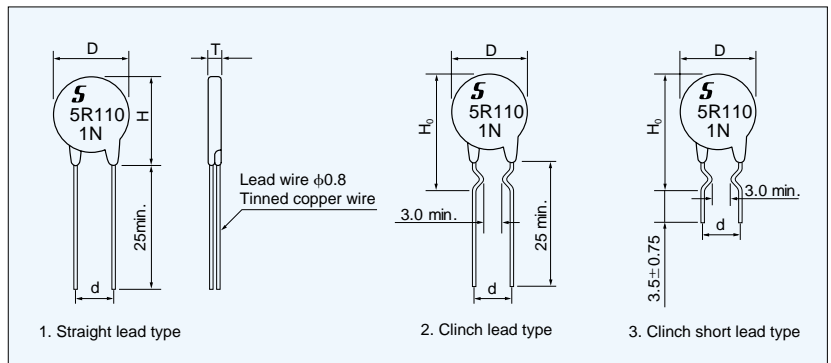

Taping

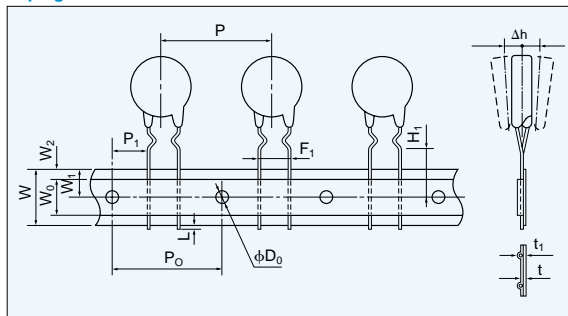

| | D | T | H | H ₀ | d |
|--------|---------|-------|----------|----------------|-------|
| M...07 | 9.5max. | 6max. | 12max. | 15max. | 7.5±1 |
| M...10 | 13max. | | 17max. | 19.5max. | |
| M...14 | 17max. | | 20.5max. | 22.5max. | |

Taping

| | P | P ₀ | P ₁ | W | W ₀ | W ₁ | W ₂ | H ₁ | L | F ₁ | φD ₀ | t | t ₁ | Δh |
|--------|------|----------------|----------------|------------------------------------|----------------|----------------|----------------|----------------|-------|----------------|-----------------|---------|----------------|-----|
| M...07 | 15±1 | 15±0.3 | 3.75±0.7 | 18 ^{+1.0} _{-0.5} | 5min. | 9±0.5 | 3max. | 16±0.5 | 1max. | 7.5±0.5 | 4±0.2 | 0.6±0.3 | 1.5max. | 0±2 |
| M...10 | 30±1 | | | | | | | | | | | | | |
| M...14 | 30±1 | | | | | | | | | | | | | |

Specifications (Disk type)

| Part No. | R ₂₅ ^{*1} (Ω) | Maximum rating current at 25°C (A) | Residual resistance ^{*2} (Ω) | Dissipation factor (mW/°C) | Thermal time constant ^{*3} (s) | Rating temp (°C) | Maximum capacitance at AC220V (μF) |
|----------|--------------------------------------|--|---|----------------------------------|--|------------------------|--|
| 5D2-05 | 5 | 1.7 | 0.610 | 14 | 25 | -40~160 | 36 |
| 8D2-05 | 8 | 1.3 | 0.970 | 14 | 27 | -40~160 | 39 |
| 10D2-05 | 10 | 1.2 | 1.210 | 14 | 31 | -40~160 | 39 |
| 12D2-05 | 12 | 1.4 | 0.860 | 14 | 26 | -40~160 | 49 |
| 16D2-05 | 16 | 1.2 | 1.150 | 14 | 30 | -40~160 | 57 |
| 3D2-07 | 3 | 2.4 | 0.370 | 30 | 35 | -40~160 | 42 |
| 5D2-07 | 5 | 3.0 | 0.352 | 30 | 35 | -40~160 | 80 |
| 8D2-07 | 8 | 2.0 | 0.562 | 30 | 41 | -40~160 | 110 |
| 10D2-07 | 10 | 2.0 | 0.706 | 30 | 45 | -40~160 | 140 |
| 12D2-07 | 12 | 1.7 | 0.780 | 30 | 41 | -40~160 | 80 |
| 16D2-07 | 16 | 2.0 | 1.125 | 30 | 45 | -40~160 | 160 |
| 22D2-07 | 22 | 1.0 | 1.547 | 30 | 50 | -40~160 | 190 |
| 2D2-10 | 2 | 5.0 | 0.107 | 32 | 50 | -40~160 | 330 |
| 3D2-10 | 3 | 4.0 | 0.160 | 32 | 53 | -40~160 | 350 |
| 5D2-10 | 5 | 4.0 | 0.267 | 32 | 53 | -40~160 | 290 |
| 8D2-10 | 8 | 3.0 | 0.427 | 32 | 70 | -40~160 | 320 |
| 10D2-10 | 10 | 3.0 | 0.533 | 32 | 75 | -40~160 | 330 |
| 12D2-10 | 12 | 1.8 | 0.780 | 32 | 53 | -40~160 | 173 |
| 16D2-10 | 16 | 1.6 | 0.940 | 32 | 70 | -40~160 | 173 |
| 2D2-14 | 2 | 5.0 | 0.107 | 36 | 90 | -40~160 | 860 |
| 3D2-14 | 3 | 5.0 | 0.160 | 36 | 80 | -40~160 | 630 |
| 4D2-14 | 4 | 5.0 | 0.213 | 36 | 95 | -40~160 | 700 |
| 5D2-14 | 5 | 4.0 | 0.267 | 36 | 110 | -40~160 | 740 |
| 8D2-14 | 8 | 2.5 | 0.470 | 36 | 80 | -40~160 | 289 |
| 10D2-14 | 10 | 2.2 | 0.590 | 36 | 95 | -40~160 | 371 |
| 12D2-14 | 12 | 2.0 | 0.710 | 36 | 105 | -40~160 | 454 |
| 16D2-14 | 16 | 1.8 | 0.940 | 36 | 115 | -40~160 | 578 |

*1 R₂₅ : Rated zero-power resistance value at 25°C.

*2 Residual resistance is the maximum value when maximum rating current is applied.

*3 Time when thermistor temperature reaches 63.2% of the temperature difference. The value is measured in the air.

Part number

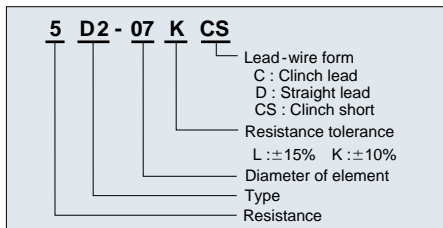

●UL approved File No. E92669 Thermistor type devices

Dimensions

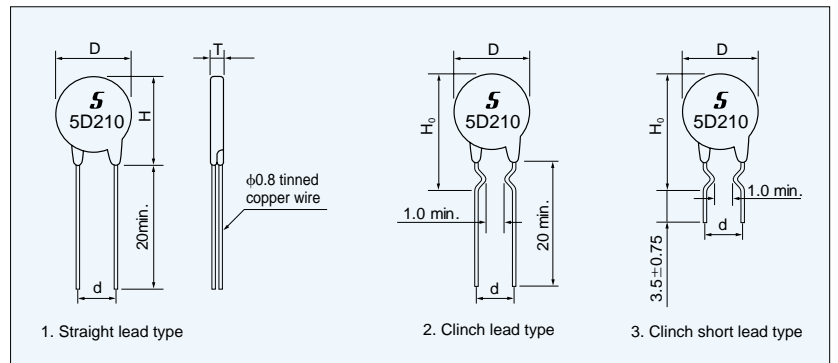

| | D | T | H | H ₀ | d |
|-------|------|---------|------|----------------|-------|
| D2-05 | 7±2 | 6.8max. | 9±2 | 14.0max. | 5.0±1 |
| D2-07 | 9±2 | | 11±2 | 15.0max. | 5.0±1 |
| D2-10 | 11±2 | | 15±2 | 19.5max. | 5.0±1 |
| D2-14 | 15±2 | | 19±2 | 22.5max. | 7.5±1 |

TRANSIENT VOLTAGE SUPPRESSOR

VRD

VRD is a transient voltage suppressor used for protecting electric circuits from surge voltage and thus preventing breakdown.

VRD has superior surge suppression characteristics, such as extremely fast response time, very low clamping voltage, and high surge capacity. Unlike metal oxide varistors, VRD does not have characteristics to change with surge variations within the rated capacity. This feature comprises another superior characteristics of the VRD as a transient voltage suppressors.

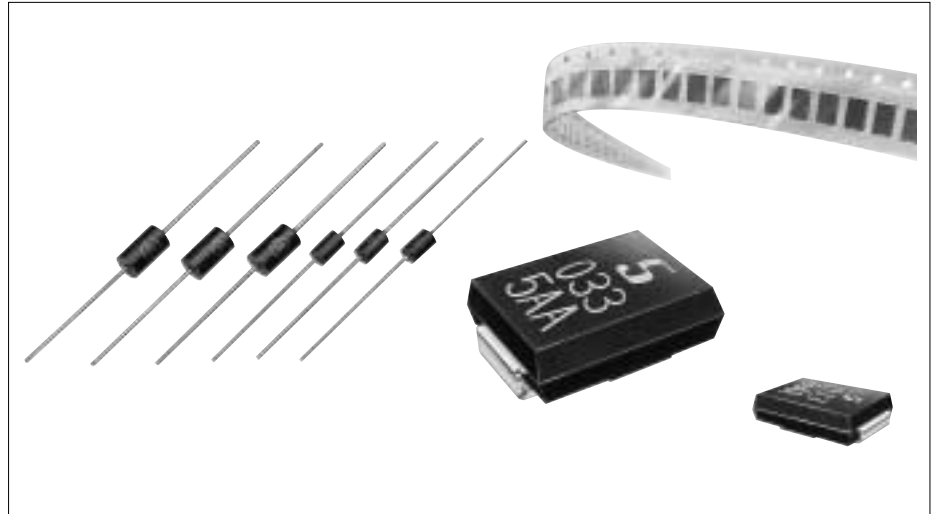

Electrical characteristics

Figure 1 shows the electrical characteristics. Bipolar type has almost symmetrical breakdown Voltage (V_b) The reverse breakdown voltage of the ZD type is 200 Volts or more at 10 μ A DC.

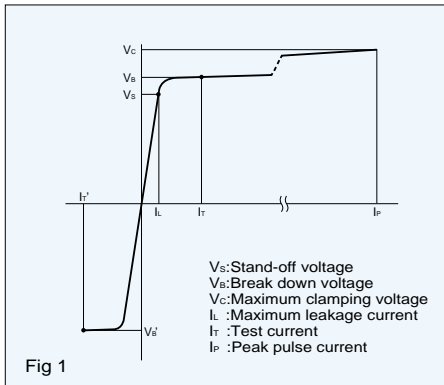

Fig 1

Taping

One of standard taping is as shown in Figure.

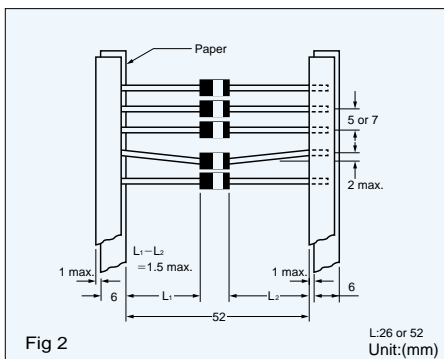

Fig 2

Surge capability

Allowable surge capability (P_m) is determined by the following equation:

$$P_m = I_p \times V_c$$

I_p : Peak current
 V_c : Maximum clamping voltage

The allowable surge capability (peak pulse power) of VRD is shown in following Figure 3 and the surge capability derating characteristics are shown in Figure 6.

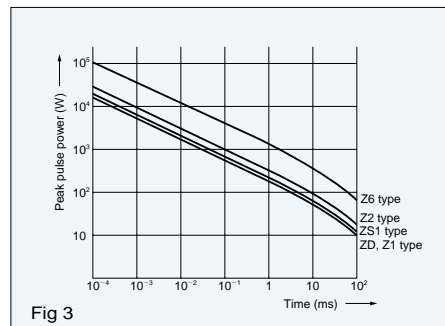

Fig 3

Surge waveform

There are many types of surge waveform depending on the source of the surge. For the VRD surge suppression characteristics test, the EXP waveform shown below is used. The EXP waveform is shown as t_a/t_b depending on the time width, however 10/1000 waveform is used as the standard test waveform.

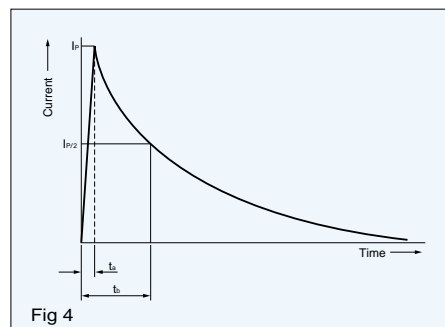

Fig 4

Surge suppression characteristics

When EXP waveform is applied to the circuit below, the surge suppression waveform shown in the figure 5 can be observed.

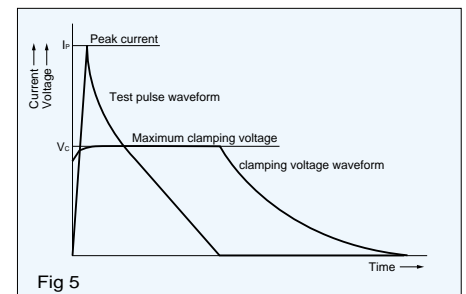

Fig 5

Power derating

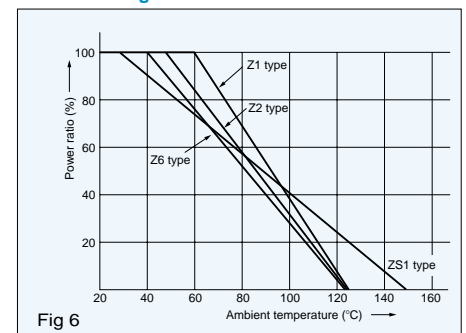

Fig 6

查询"563CT-4"供应商

Z1 type VRD has bipolar electrical characteristics.

Maximum ratings
 Peak pulse power: 250 W (10/1000 μ s)
 3.00 kW (8/20 μ s)
 Steady state power dissipation: 500 mW
 Operating and storage temperature
 : -40°C to 125°C

Symbol mark

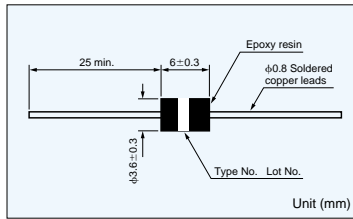

| Bi-polar type | Stand-off voltage V_s V | Maximum leakage current I_L μ A | Breakdown voltage V_B V | Test current I_T mA | Maximum clamping voltage & Maximum peak pulse current | | | | Max. temp. coef. %/°C | Capacitance (TYP) pF |
|---------------|---------------------------------|---|---------------------------------|-----------------------------|---|------------|--------------|------------|-----------------------|----------------------|
| | | | | | 10/1000 μ s | | 8/20 μ s | | | |
| | | | | | V_C V | I_P A | V_C V | I_P A | | |
| Z1015 | 12.1 | 5 | 13.5-16.5 | 1 | 22.0 | 11.3 | 28.4 | 106. | 0.075 | 450 |
| Z1018 | 14.5 | 5 | 16.2-19.8 | 1 | 26.5 | 9.43 | 34.0 | 89.1 | 0.079 | 360 |
| Z1022 | 17.8 | 5 | 19.8-24.2 | 1 | 31.9 | 7.83 | 41.2 | 73.5 | 0.082 | 290 |
| Z1027 | 21.8 | 5 | 24.3-29.7 | 1 | 39.1 | 6.39 | 50.5 | 60.0 | 0.085 | 240 |
| Z1033 | 26.8 | 5 | 29.7-36.3 | 1 | 47.7 | 5.24 | 61.7 | 49.1 | 0.087 | 200 |
| Z1039 | 31.6 | 5 | 35.1-42.9 | 1 | 56.4 | 4.43 | 73.0 | 41.5 | 0.090 | 170 |
| Z1047 | 38.1 | 5 | 42.3-51.7 | 1 | 67.8 | 3.69 | 88.0 | 34.4 | 0.092 | 140 |
| Z1056 | 45.4 | 5 | 50.4-61.6 | 1 | 80.5 | 3.10 | 105.0 | 28.8 | 0.094 | 110 |
| Z1068 | 55.1 | 5 | 61.2-74.8 | 1 | 98.0 | 2.55 | 127.0 | 23.8 | 0.096 | 90 |
| Z1082 | 66.4 | 5 | 73.8-90.2 | 1 | 118.0 | 2.14 | 153.0 | 19.8 | 0.099 | 80 |
| Z1100 | 81.0 | 5 | 90.0-110 | 1 | 144.0 | 1.73 | 187.0 | 16.2 | 0.101 | 65 |
| Z1120 | 97.0 | 5 | 108-132 | 1 | 173.0 | 1.44 | 222.0 | 13.6 | 0.103 | 53 |
| Z1150 | 121.0 | 5 | 135-165 | 1 | 215.0 | 1.16 | 277.0 | 10.9 | 0.105 | 42 |

Z2 type VRD has bipolar or unipolar electrical characteristics.

Maximum ratings
 Peak pulse power: 500 W (10/1000 μ s)
 6.00 kW (8/20 μ s)
 Steady state power dissipation: 1W
 Operating and storage temperature
 : -40°C to 125°C

Symbol mark

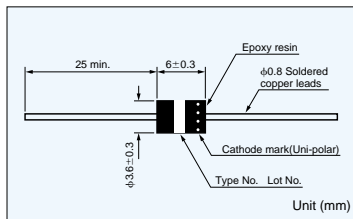
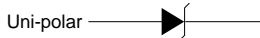

| Bi-polar type | Uni-polar type | Stand-off voltage V_s V | Maximum leakage current I_L μ A | Breakdown voltage V_B V | Test current I_T mA | Maximum clamping voltage & Maximum peak pulse current | | | | Max. temp. coef. %/°C | Capacitance (TYP) pF |
|---------------|----------------|---------------------------------|---|---------------------------------|-----------------------------|---|------------|--------------|------------|-----------------------|----------------------|
| | | | | | | 10/1000 μ s | | 8/20 μ s | | | |
| | | | | | | V_C V | I_P A | V_C V | I_P A | | |
| Z2008 | - | 6.63 | 500 | 7.38-9.02 | 10 | 12.5 | 40.0 | 16.3 | 372 | 0.045 | 1200 |
| - | Z2008U | 6.63 | 500 | 7.38-9.02 | 10 | 12.5 | 40.0 | 16.3 | 372 | 0.063 | 2400 |
| Z2010 | - | 8.10 | 100 | 9.00-11.0 | 1 | 15.0 | 33.4 | 19.5 | 311 | 0.055 | 950 |
| - | Z2010U | 8.10 | 20 | 9.00-11.0 | 1 | 15.0 | 33.4 | 19.5 | 311 | 0.071 | 1900 |
| Z2012 | - | 9.72 | 5 | 10.8-13.2 | 1 | 17.3 | 28.9 | 22.7 | 267 | 0.066 | 790 |
| - | Z2012U | 9.72 | 5 | 10.8-13.2 | 1 | 17.3 | 28.9 | 22.7 | 267 | 0.074 | 1580 |
| Z2015 | - | 12.1 | 5 | 13.5-16.5 | 1 | 22.0 | 22.7 | 28.4 | 213 | 0.075 | 640 |
| - | Z2015U | 12.1 | 5 | 13.5-16.5 | 1 | 22.0 | 22.7 | 28.4 | 213 | 0.079 | 1280 |
| Z2018 | - | 14.5 | 5 | 16.2-19.8 | 1 | 26.5 | 18.8 | 34.0 | 178 | 0.079 | 520 |
| - | Z2018U | 14.5 | 5 | 16.2-19.8 | 1 | 26.5 | 18.8 | 34.0 | 178 | 0.083 | 1040 |
| Z2022 | - | 17.8 | 5 | 19.8-24.2 | 1 | 31.9 | 15.7 | 41.2 | 147 | 0.082 | 420 |
| - | Z2022U | 17.8 | 5 | 19.8-24.2 | 1 | 31.9 | 15.7 | 41.2 | 147 | 0.086 | 840 |
| Z2027 | - | 21.8 | 5 | 24.3-29.7 | 1 | 39.1 | 12.8 | 50.5 | 120 | 0.085 | 340 |
| - | Z2027U | 21.8 | 5 | 24.3-29.7 | 1 | 39.1 | 12.8 | 50.5 | 120 | 0.089 | 680 |
| Z2033 | - | 26.8 | 5 | 29.7-36.3 | 1 | 47.7 | 10.5 | 61.7 | 98.2 | 0.087 | 280 |
| - | Z2033U | 26.8 | 5 | 29.7-36.3 | 1 | 47.7 | 10.5 | 61.7 | 98.2 | 0.092 | 560 |
| Z2039 | - | 31.6 | 5 | 35.1-42.9 | 1 | 56.4 | 8.86 | 73.0 | 83.0 | 0.090 | 240 |
| - | Z2039U | 31.6 | 5 | 35.1-42.9 | 1 | 56.4 | 8.86 | 73.0 | 83.0 | 0.095 | 480 |
| Z2047 | - | 38.1 | 5 | 42.3-51.7 | 1 | 67.8 | 7.37 | 88.0 | 68.9 | 0.092 | 200 |
| - | Z2047U | 38.1 | 5 | 42.3-51.7 | 1 | 67.8 | 7.37 | 88.0 | 68.9 | 0.097 | 400 |
| Z2056 | - | 45.4 | 5 | 50.4-61.6 | 1 | 80.5 | 6.21 | 105.0 | 57.7 | 0.094 | 160 |
| - | Z2056U | 45.4 | 5 | 50.4-61.6 | 1 | 80.5 | 6.21 | 105.0 | 57.7 | 0.099 | 320 |
| Z2068 | - | 55.1 | 5 | 61.2-74.8 | 1 | 98.0 | 5.10 | 127.0 | 47.7 | 0.096 | 130 |
| - | Z2068U | 55.1 | 5 | 61.2-74.8 | 1 | 98.0 | 5.10 | 127.0 | 47.7 | 0.100 | 260 |
| Z2082 | - | 66.4 | 5 | 73.8-90.2 | 1 | 118.0 | 4.24 | 153.0 | 39.6 | 0.099 | 110 |
| - | Z2082U | 66.4 | 5 | 73.8-90.2 | 1 | 118.0 | 4.24 | 153.0 | 39.6 | 0.102 | 220 |
| Z2100 | - | 81.0 | 5 | 90.0-110 | 1 | 144.0 | 3.47 | 187.0 | 32.4 | 0.101 | 90 |
| - | Z2100U | 81.0 | 5 | 90.0-110 | 1 | 144.0 | 3.47 | 187.0 | 32.4 | 0.104 | 180 |
| Z2120 | - | 97.2 | 5 | 108-132 | 1 | 173.0 | 2.89 | 222.0 | 27.3 | 0.103 | 75 |
| - | Z2120U | 97.2 | 5 | 108-132 | 1 | 173.0 | 2.89 | 222.0 | 27.3 | 0.106 | 150 |
| Z2150 | - | 121.0 | 5 | 135-165 | 1 | 215.0 | 2.32 | 277.0 | 21.9 | 0.105 | 60 |
| - | Z2150U | 121.0 | 5 | 135-165 | 1 | 215.0 | 2.32 | 277.0 | 21.9 | 0.107 | 120 |
| Z2180 | - | 146.0 | 5 | 162-198 | 1 | 258.0 | 1.94 | 333.0 | 18.2 | 0.106 | 49 |
| - | Z2180U | 146.0 | 5 | 162-198 | 1 | 258.0 | 1.94 | 333.0 | 18.2 | 0.108 | 98 |

NOTE: Nonsuffix: bi-polar, suffix "U" : uni-polar.

查询"563CT-4"供应商

| Bi-polar type | Uni-polar type | Stand-off voltage V _s V | Maximum leakage current I _L μA | Breakdown voltage V _B V | Test current I _T mA | Maximum clamping voltage & Maximum peak pulse current | | | | Max. temp. coef. %/°C | Capacitance (TYP) pF |
|---------------|----------------|--|---|--|--------------------------------------|---|---------------------|---------------------|---------------------|-----------------------|----------------------|
| | | | | | | 10/1000μs | | 8/20μs | | | |
| | | | | | | V _C V | I _p A | V _C V | I _p A | | |
| - | Z6008U | 6.63 | 500 | 7.38-9.02 | 10 | 12.5 | 120 | 16.3 | 1120 | 0.063 | 14600 |
| Z6010 | - | 8.10 | 200 | 9.00-11.0 | 1 | 15.0 | 100 | 19.5 | 933 | 0.055 | 5600 |
| - | Z6010U | 8.10 | 50 | 9.00-11.0 | 1 | 15.0 | 100 | 19.5 | 933 | 0.071 | 11200 |
| Z6012 | - | 9.72 | 10 | 10.8-13.2 | 1 | 17.3 | 86.7 | 22.7 | 802 | 0.066 | 4400 |
| - | Z6012U | 9.72 | 5 | 10.8-13.2 | 1 | 17.3 | 86.7 | 22.7 | 802 | 0.074 | 8800 |
| Z6015 | - | 12.1 | 5 | 13.5-16.5 | 1 | 22.0 | 68.2 | 28.4 | 641 | 0.075 | 3300 |
| - | Z6015U | 12.1 | 5 | 13.5-16.5 | 1 | 22.0 | 68.2 | 28.4 | 641 | 0.079 | 6600 |
| Z6018 | - | 14.5 | 5 | 16.2-19.8 | 1 | 26.5 | 56.6 | 34.0 | 535 | 0.079 | 2700 |
| - | Z6018U | 14.5 | 5 | 16.2-19.8 | 1 | 26.5 | 56.6 | 34.0 | 535 | 0.083 | 5400 |
| Z6022 | - | 17.8 | 5 | 19.8-24.2 | 1 | 31.9 | 47.0 | 41.2 | 442 | 0.082 | 2400 |
| - | Z6022U | 17.8 | 5 | 19.8-24.2 | 1 | 31.9 | 47.0 | 41.2 | 442 | 0.086 | 4400 |
| Z6027 | - | 21.8 | 5 | 24.3-29.7 | 1 | 39.1 | 38.5 | 50.5 | 360 | 0.085 | 1700 |
| - | Z6027U | 21.8 | 5 | 24.3-29.7 | 1 | 39.1 | 38.4 | 50.5 | 360 | 0.089 | 3300 |
| Z6033 | - | 26.8 | 5 | 29.7-36.3 | 1 | 47.7 | 31.4 | 61.7 | 295 | 0.087 | 1400 |
| - | Z6033U | 26.8 | 5 | 29.7-36.3 | 1 | 47.7 | 31.4 | 61.7 | 295 | 0.092 | 2800 |
| Z6039 | - | 31.6 | 5 | 35.1-42.9 | 1 | 56.4 | 26.6 | 73.0 | 249 | 0.090 | 1200 |
| - | Z6039U | 31.6 | 5 | 35.1-42.9 | 1 | 56.4 | 26.6 | 73.0 | 249 | 0.095 | 2400 |
| Z6047 | - | 38.1 | 5 | 42.3-51.7 | 1 | 67.8 | 22.1 | 88.0 | 207 | 0.092 | 1000 |
| - | Z6047U | 38.1 | 5 | 42.3-51.7 | 1 | 67.8 | 22.1 | 88.0 | 207 | 0.097 | 2000 |
| Z6056 | - | 45.4 | 5 | 50.4-61.6 | 1 | 80.5 | 18.6 | 105.0 | 173 | 0.094 | 850 |
| - | Z6056U | 45.4 | 5 | 50.4-61.6 | 1 | 80.5 | 18.6 | 105.0 | 173 | 0.099 | 1700 |
| Z6068 | - | 55.1 | 5 | 61.2-74.8 | 1 | 98.0 | 15.3 | 127.0 | 143 | 0.096 | 720 |
| - | Z6068U | 55.1 | 5 | 61.2-74.8 | 1 | 98.0 | 15.3 | 127.0 | 143 | 0.100 | 1440 |
| Z6082 | - | 66.4 | 5 | 73.8-90.2 | 1 | 118.0 | 12.7 | 153.0 | 119 | 0.099 | 610 |
| - | Z6082U | 66.4 | 5 | 73.8-90.2 | 1 | 118.0 | 12.7 | 153.0 | 119 | 0.102 | 1220 |
| Z6100 | - | 81.0 | 5 | 90.0-110 | 1 | 144.0 | 10.4 | 187.0 | 97.3 | 0.101 | 520 |
| - | Z6100U | 81.0 | 5 | 90.0-110 | 1 | 144.0 | 10.4 | 187.0 | 97.3 | 0.104 | 1040 |
| Z6120 | - | 97.2 | 5 | 108-132 | 1 | 173.0 | 8.67 | 222.0 | 82.0 | 0.103 | 440 |
| - | Z6120U | 97.2 | 5 | 108-132 | 1 | 173.0 | 8.67 | 222.0 | 82.0 | 0.106 | 880 |
| - | Z6150U | 121.0 | 5 | 135-165 | 1 | 215.0 | 6.98 | 277.0 | 65.7 | 0.107 | 720 |

NOTE : Nonsuffix : Bi-polar, suffix "U" : Uni-polar.

Z6 type VRD has bipolar or unipolar electrical characteristics.

Maximum ratings
Peak pulse power:1.5kW(10/1000μs)
18.0kW(8/20μs)
Steady state power dissipation:2W
Operating and storage temperature
:-40°C to 125°C

Symbol mark

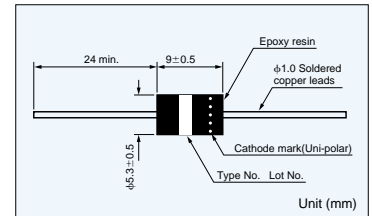
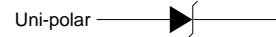

| VRD type No. | Stand-off voltage V _s V | Maximum leakage current I _L μA | Breakdown voltage V _B V | Test current I _T mA | Maximum clamping voltage & Maximum peak pulse current | | | | Max. temp. coef. %/°C | Capacitance (TYP) pF |
|--------------|--|---|--|--------------------------------------|---|---------------------|---------------------|---------------------|-----------------------|----------------------|
| | | | | | 10/1000μs | | 8/20μs | | | |
| | | | | | V _C V | I _p A | V _C V | I _p A | | |
| ZD015 | 11.4 | 10 | 12.8-17.2 | 1 | 24.0 | 10.4 | 31.0 | 96.7 | 0.075 | 31.5 |
| ZD018 | 13.7 | 10 | 15.3-20.7 | 1 | 28.0 | 8.93 | 36.0 | 83.3 | 0.079 | 31.0 |
| ZD022 | 16.8 | 5 | 18.7-25.3 | 1 | 33.2 | 7.53 | 43.0 | 69.7 | 0.082 | 29.0 |
| ZD027 | 20.6 | 5 | 23.0-31.0 | 1 | 40.0 | 6.25 | 52.0 | 57.7 | 0.085 | 28.2 |
| ZD033 | 25.2 | 5 | 28.1-37.9 | 1 | 48.6 | 5.14 | 63.0 | 47.6 | 0.087 | 27.2 |
| ZD039 | 29.8 | 5 | 33.2-44.8 | 1 | 57.4 | 4.35 | 74.0 | 40.5 | 0.090 | 26.3 |
| ZD047 | 35.9 | 5 | 40.0-54.0 | 1 | 68.5 | 3.65 | 89.0 | 33.7 | 0.092 | 25.0 |
| ZD056 | 42.8 | 5 | 47.6-64.4 | 1 | 81.0 | 3.08 | 106.0 | 28.6 | 0.094 | 24.1 |
| ZD068 | 52.0 | 5 | 57.8-78.2 | 1 | 98.0 | 2.55 | 127.0 | 23.8 | 0.096 | 22.0 |

Low capacitance type

Maximum ratings
Reverse voltage:200 VDC
Peak pulse power:250 W(10/1000μs)
3.00 kW(8/20μs)
Steady state power dissipation:500 mW
Operating and storage temperature
:-40°C to 125°C

Symbol mark

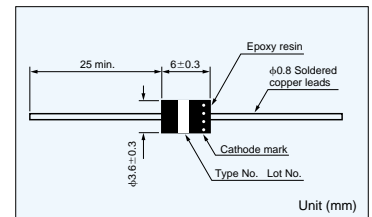

SMD VRD

Part number

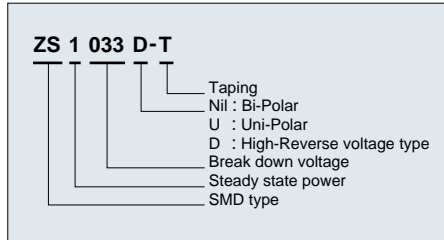

Dimensions

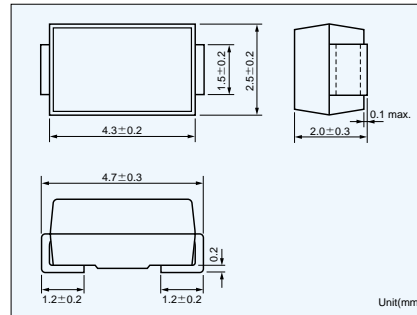

Marking

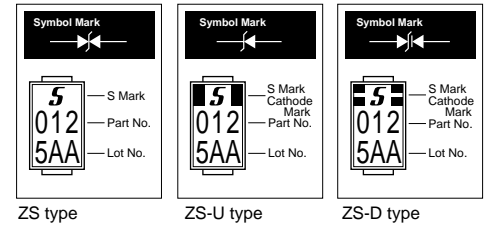

| | Maximum Rating |
|--------------------------------|-----------------------|
| Steady state power dissipation | 1.0W |
| Peak pulse power | 300W(10/1000 μ s) |
| | 1200W(1.2/50 μ s) |
| | 2000W(8/20 μ s) |
| Storage temp. range | -40~150°C |

Taping

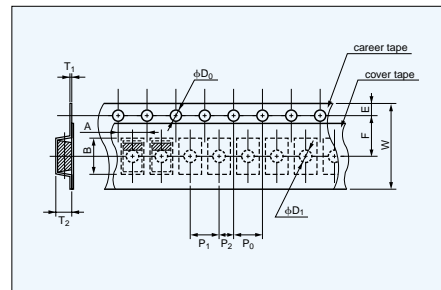

| A | B | W | F | E | P ₁ | P ₂ | P ₀ | φD ₀ | φD ₁ | T ₁ | T ₂ |
|-------------|-------------|--------------|--------------|--------------|----------------|----------------|----------------|-------------------|-------------------|----------------|----------------|
| 3.0 ±0.1 | 5.2 ±0.1 | 12.0 ±0.3 | 5.5 ±0.05 | 1.75 ±0.1 | 4.0 ±0.1 | 2.0 ±0.1 | 4.0 ±0.1 | 1.5 +0.1 -0 | 1.5 +0.2 -0 | 0.3 ±0.05 | (2.6) |

Unit (mm)

Dimension of reel

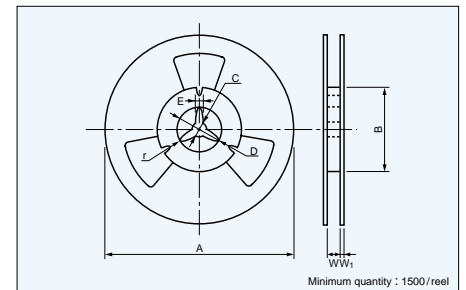

| A | B | C | D | E | W | W ₁ | r |
|--------------|-------------|-------------|-------------|-------------|--------------|---------------------|-------|
| φ178 ±2.0 | φ80 ±1.0 | φ13 ±0.5 | φ21 ±0.8 | 2.0 ±0.5 | 14.0 ±1.5 | 1.5 +0.5 -1.0 | (1.0) |

Unit (mm)

Specifications

ZS type

| Part No. | Breakdown voltage | Stand-off voltage | Maximum leakage current | Maximum clamping voltage & Maximum peak pulse current | | | | Temperature coefficient | Capacitance (TYP) | | | |
|----------|-------------------|-------------------|-------------------------|---|----------------|--------------------|------------------------------------|-------------------------|-------------------|--------------|---|---|
| | | | | V _B | V _S | I _L max | V _C max/I _{PP} | | | | | |
| | | | | | | | 10/1000 μ s | | | 8/20 μ s | | |
| | | | | | | | V | | | A | V | A |
| ZS1012 | 12(10.8~13.2) | 9.72 | 10 | 17.3 | 17.3 | 22.4 | 89.3 | 0.066 | 551 | | | |
| ZS1015 | 15(13.5~16.5) | 12.1 | 5 | 22.0 | 13.6 | 28.5 | 70.2 | 0.075 | 465 | | | |
| ZS1018 | 18(16.2~19.8) | 14.5 | 5 | 26.5 | 11.3 | 34.4 | 58.1 | 0.079 | 376 | | | |
| ZS1022 | 22(19.8~24.2) | 17.8 | 5 | 31.9 | 9.40 | 41.4 | 48.3 | 0.082 | 299 | | | |
| ZS1027 | 27(24.3~29.7) | 21.8 | 5 | 39.1 | 7.67 | 50.7 | 39.4 | 0.085 | 248 | | | |
| ZS1033 | 33(29.7~36.3) | 26.8 | 5 | 47.7 | 6.29 | 61.8 | 32.4 | 0.087 | 198 | | | |
| ZS1039 | 39(35.1~42.9) | 31.6 | 5 | 56.4 | 5.32 | 73.1 | 27.4 | 0.090 | 164 | | | |
| ZS1047 | 47(42.3~51.7) | 38.1 | 5 | 67.8 | 4.42 | 88.0 | 22.7 | 0.092 | 137 | | | |

ZS-U type

| Part No. | Breakdown voltage | Stand-off voltage | Maximum leakage current | Maximum clamping voltage & Maximum peak pulse current | | | | Temperature coefficient | Capacitance (TYP) | | | |
|----------|-------------------|-------------------|-------------------------|---|----------------|--------------------|------------------------------------|-------------------------|-------------------|--------------|---|---|
| | | | | V _B | V _S | I _L max | V _C max/I _{PP} | | | | | |
| | | | | | | | 10/1000 μ s | | | 8/20 μ s | | |
| | | | | | | | V | | | A | V | A |
| ZS1012U | 12(10.8~13.2) | 9.72 | 10 | 17.3 | 17.3 | 22.4 | 89.3 | 0.066 | 1,102 | | | |
| ZS1015U | 15(13.5~16.5) | 12.1 | 5 | 22.0 | 13.6 | 28.5 | 70.2 | 0.075 | 929 | | | |
| ZS1018U | 18(16.2~19.8) | 14.5 | 5 | 26.5 | 11.3 | 34.4 | 58.1 | 0.079 | 751 | | | |
| ZS1022U | 22(19.8~24.2) | 17.8 | 5 | 31.9 | 9.40 | 41.4 | 48.3 | 0.082 | 598 | | | |
| ZS1027U | 27(24.3~29.7) | 21.8 | 5 | 39.1 | 7.67 | 50.7 | 39.4 | 0.085 | 497 | | | |
| ZS1033U | 33(29.7~36.3) | 26.8 | 5 | 47.7 | 6.29 | 61.8 | 32.4 | 0.087 | 395 | | | |
| ZS1039U | 39(35.1~42.9) | 31.6 | 5 | 56.4 | 5.32 | 73.1 | 27.4 | 0.090 | 328 | | | |
| ZS1047U | 47(42.3~51.7) | 38.1 | 5 | 67.8 | 4.42 | 88.0 | 22.7 | 0.092 | 274 | | | |

ZS-D type

| Part No. | Breakdown voltage | Stand-off voltage | Maximum leakage current | Maximum clamping voltage & Maximum peak pulse current | | | | Temperature coefficient | Capacitance (TYP) | | | |
|----------|-------------------|-------------------|-------------------------|---|----------------|--------------------|------------------------------------|-------------------------|-------------------|--------------|---|---|
| | | | | V _B | V _S | I _L max | V _C max/I _{PP} | | | | | |
| | | | | | | | 10/1000 μ s | | | 8/20 μ s | | |
| | | | | | | | V | | | A | V | A |
| ZS1012D | 12(10.8~13.2) | 9.72 | 10 | 17.3 | 17.3 | 22.4 | 89.3 | 0.066 | 30.2 | | | |
| ZS1015D | 15(13.5~16.5) | 12.1 | 5 | 22.0 | 13.6 | 28.5 | 70.2 | 0.075 | 29.1 | | | |
| ZS1018D | 18(16.2~19.8) | 14.5 | 5 | 26.5 | 11.3 | 34.4 | 58.1 | 0.079 | 28.2 | | | |
| ZS1022D | 22(19.8~24.2) | 17.8 | 5 | 31.9 | 9.40 | 41.4 | 48.3 | 0.082 | 27.3 | | | |
| ZS1027D | 27(24.3~29.7) | 21.8 | 5 | 39.1 | 7.67 | 50.7 | 39.4 | 0.085 | 26.4 | | | |
| ZS1033D | 33(29.7~36.3) | 26.8 | 5 | 47.7 | 6.29 | 61.8 | 32.4 | 0.087 | 25.5 | | | |
| ZS1039D | 39(35.1~42.9) | 31.6 | 5 | 56.4 | 5.32 | 73.1 | 27.4 | 0.090 | 24.8 | | | |
| ZS1047D | 47(42.3~51.7) | 38.1 | 5 | 67.8 | 4.42 | 88.0 | 22.7 | 0.092 | 24.0 | | | |

CURRENT REGULATIVE DIODE

CRD

CRD is a diode which supplies constant current to an electric circuit, even when power supply voltage fluctuations or load impedance fluctuations occur.

CRD is used for current stabilization and current limiting.

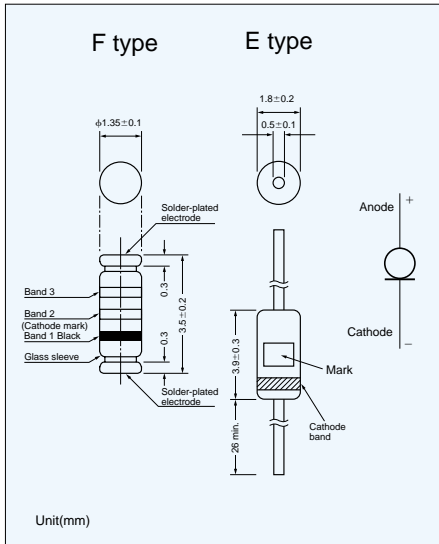
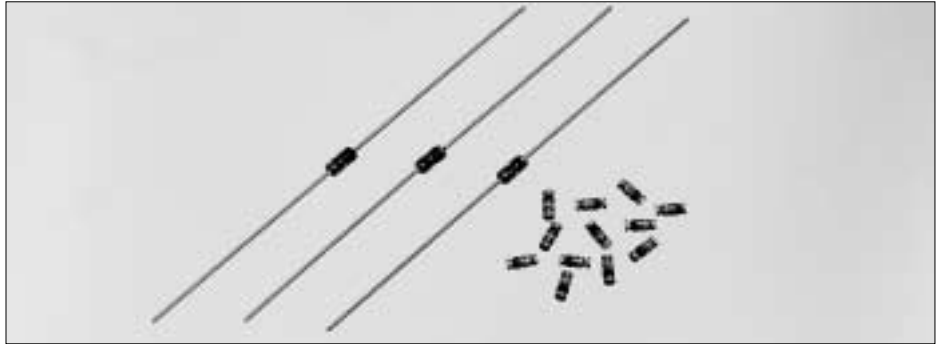

Basic characteristics

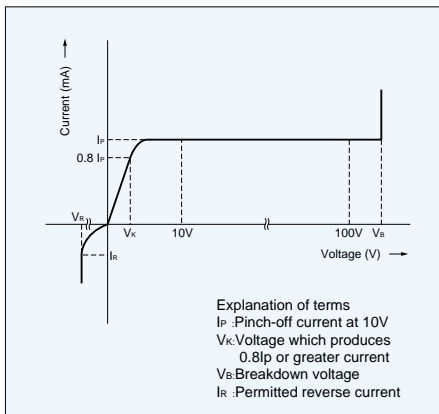

Maximum ratings

| | E type | F type |
|--------------------|-------------|---------|
| Rating power | 300mW | 400mW |
| Thermal resistance | 300°C/W | 150°C/W |
| Reverse current | 50mA | |
| Operating temp | -30°C~150°C | |

Maximum rating voltage

| Part No. | Voltage | Part No. | Voltage |
|-------------|---------|-------------|---------|
| E101L~E-562 | 100V | F101L~F-562 | 100V |
| E-822 | 30 | F-822 | 50 |
| E-103 | 30 | F-103 | 42 |
| E-123 | 30 | F-123 | 34 |
| E-153 | 25 | F-153 | 28 |

Specifications

| Part No. | Pinch-off current*1 | Limiting current*2 | Dynamic impedance*3 | Limiting current ratio | Temperature coefficient | Indication | | | | | |
|-----------|---------------------|--------------------|---------------------|------------------------|-------------------------|---------------------|---------------------------|-------------|--------------|--------------|------|
| | | | | | | F type | | E | | | |
| lead less | with lead | Test Voltage | I_p (mA) | V_k (V) | I_k (mA) | Z_T (M Ω) | $I_{100V}/I_p^{150V}/I_p$ | (%/°C) | Band 2 | Band 3 | Type |
| F-101L | E-101L | 10V | 0.01~0.06 | 0.4 | 0.8Ipmin. | 8.00 | 1.1 max. | +2.10~+0.10 | Light blue | White | 1L |
| F-101 | E-101 | 10V | 0.05~0.21 | 0.5 | 0.8Ipmin. | 6.00 | 1.1 max. | +2.10~+0.10 | Light blue | Pink | 01 |
| F-301 | E-301 | 10V | 0.20~0.42 | 0.8 | 0.8Ipmin. | 4.00 | 1.1 max. | +0.40~-0.20 | Light blue | Orange | 03 |
| F-501 | E-501 | 10V | 0.40~0.63 | 1.1 | 0.8Ipmin. | 2.00 | 1.1 max. | +0.15~-0.25 | Light blue | Yellow green | 05 |
| F-701 | E-701 | 10V | 0.60~0.92 | 1.4 | 0.8Ipmin. | 1.00 | 1.1 max. | 0.00~-0.32 | Light blue | Blue | 07 |
| F-102 | E-102 | 10V | 0.88~1.32 | 1.7 | 0.8Ipmin. | 0.65 | 1.1 max. | -0.10~-0.37 | Yellow green | Pink | 10 |
| F-152 | E-152 | 10V | 1.28~1.72 | 2.0 | 0.8Ipmin. | 0.40 | 1.1 max. | -0.13~-0.40 | Yellow green | Orange | 15 |
| F-202 | E-202 | 10V | 1.68~2.32 | 2.3 | 0.8Ipmin. | 0.25 | 1.1 max. | -0.15~-0.42 | Yellow green | Yellow green | 20 |
| F-272 | E-272 | 10V | 2.28~3.10 | 2.7 | 0.8Ipmin. | 0.15 | 1.1 max. | -0.18~-0.45 | Yellow green | Light blue | 27 |
| F-352 | E-352 | 10V | 3.00~4.10 | 3.2 | 0.8Ipmin. | 0.10 | 1.1 max. | -0.20~-0.47 | Yellow green | Blue | 35 |
| F-452 | E-452 | 10V | 3.90~5.10 | 3.7 | 0.8Ipmin. | 0.07 | 1.1 max. | -0.22~-0.50 | Yellow green | Purple | 45 |
| F-562 | E-562 | 10V | 5.00~6.50 | 4.5 | 0.8Ipmin. | 0.04 | 1.1 max. | -0.25~-0.53 | Yellow green | White | 56 |
| F-822 | E-822 | 10V | 6.56~9.84 | 3.1 | 0.8Ipmin. | 0.32 | *1.0 max. | -0.25~-0.45 | Yellow green | Yellow | 82 |
| F-103 | E-103 | 10V | 8.00~12.0 | 3.5 | 0.8Ipmin. | 0.17 | *1.0 max. | -0.25~-0.45 | Orange | Pink | 10 |
| F-123 | E-123 | 10V | 9.60~14.4 | 3.8 | 0.8Ipmin. | 0.08 | *1.0 max. | -0.25~-0.45 | Orange | White | 12 |
| F-153 | E-153 | 10V | 12.0~18.0 | 4.3 | 0.8Ipmin. | 0.03 | *1.0 max. | -0.25~-0.45 | Orange | Light blue | 15 |

*1,2 Pinch-off current limiting current are measured by impulse wave at 25°C
 *3 Z_T is minimum AC impedance when small AC signal voltage of 10KHz is added to 25 Vdc bias. Z_T is used as the reference value.
 *4 Temperature coefficient is measured between 25°C and 50°C.

Taping

There are three Types for taping.

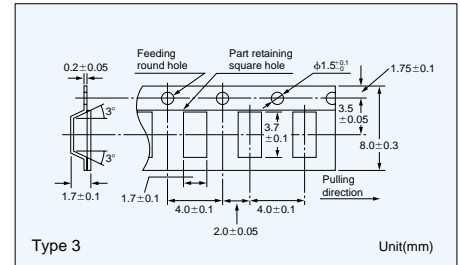
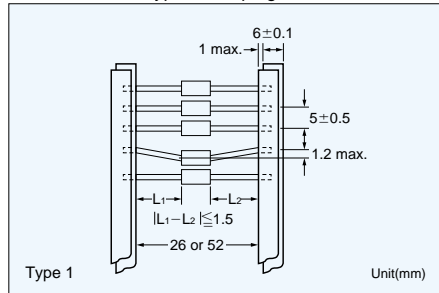

*In principal elements are set with cathode side on the round hole side.

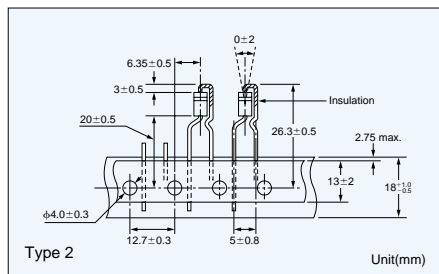

Minimum taping quantity for

- Type 1 Roll.....5000pcs
- Box.....2500pcs
- Type 2 4000pcs
- Type 3 2500pcs

Power derating

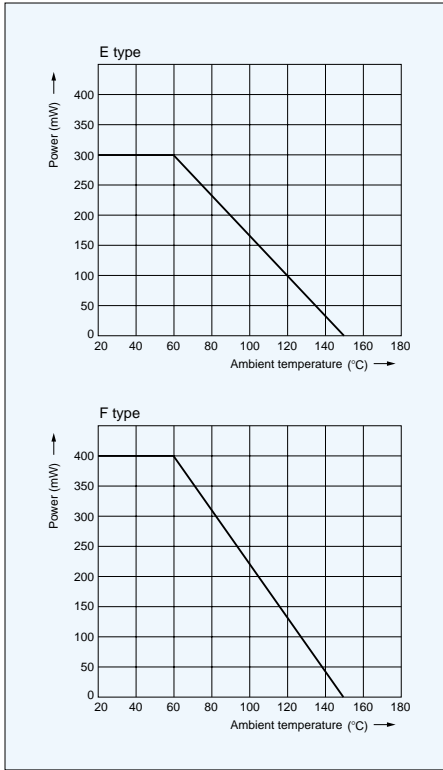

Pinch-off current Temperature

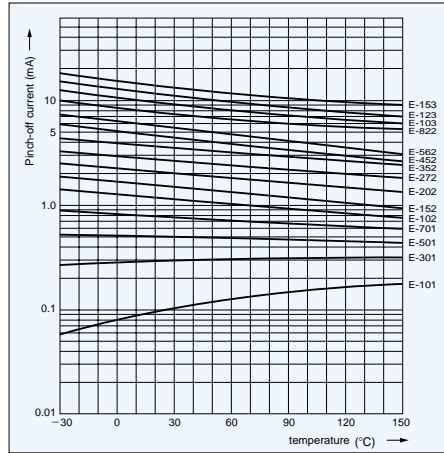

CRD in parallel

The use of CRD in parallel increases their current handling capabilities.

Increasing the voltage range using a zener diode

Connecting zener diodes in series with the line ensures that the current is constant in high-voltage area.

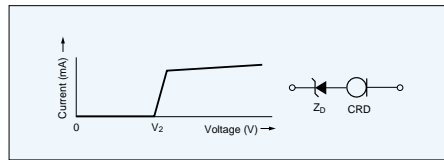

The compensation of current reduction due to self heating

Placing resistors in parallel with CRD can correct any current decrease when the applied voltage increases. The following values are typical for correction resistors.

| | | | |
|-------|-------|-------|------|
| E-102 | 1MΩ | E-352 | 82kΩ |
| E-152 | 390kΩ | E-452 | 56kΩ |
| E-202 | 240kΩ | E-562 | 39kΩ |
| E-272 | 120kΩ | | |

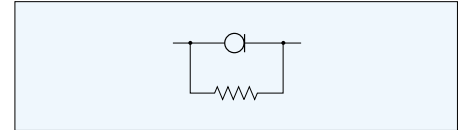

Compensative resistor is not necessary if the current value is less than 1 mA.

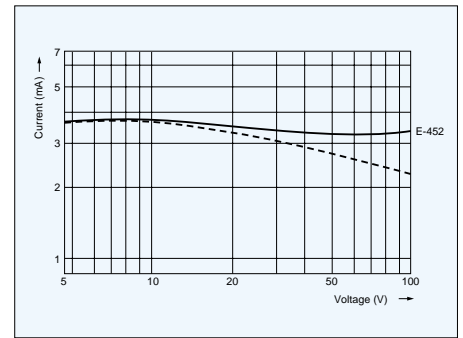

Dynamic characteristics (saturation characteristics)

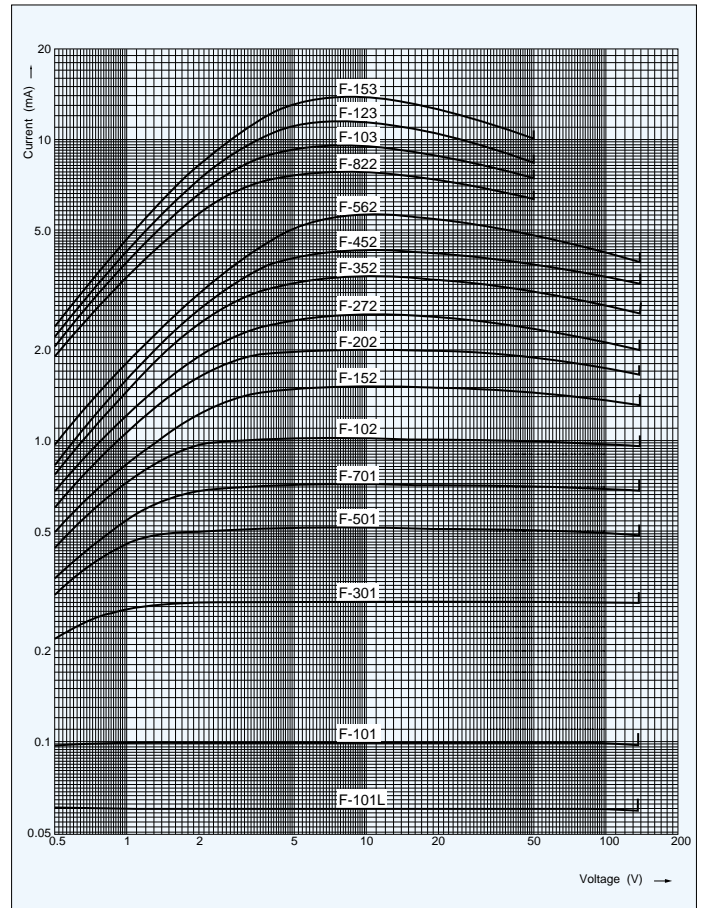
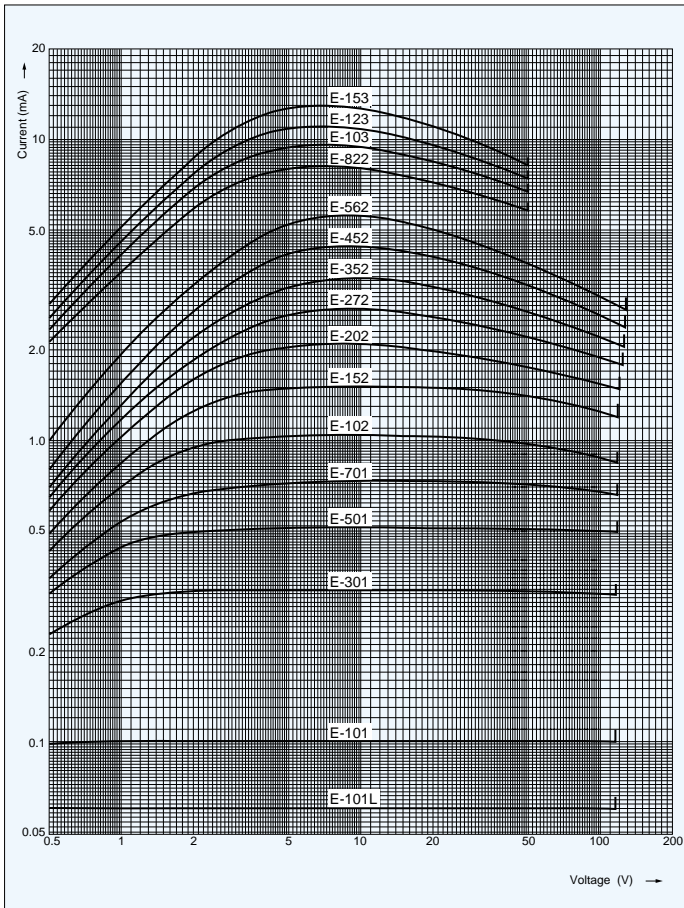

METAL OXIDE VARISTOR

ZENAMIC

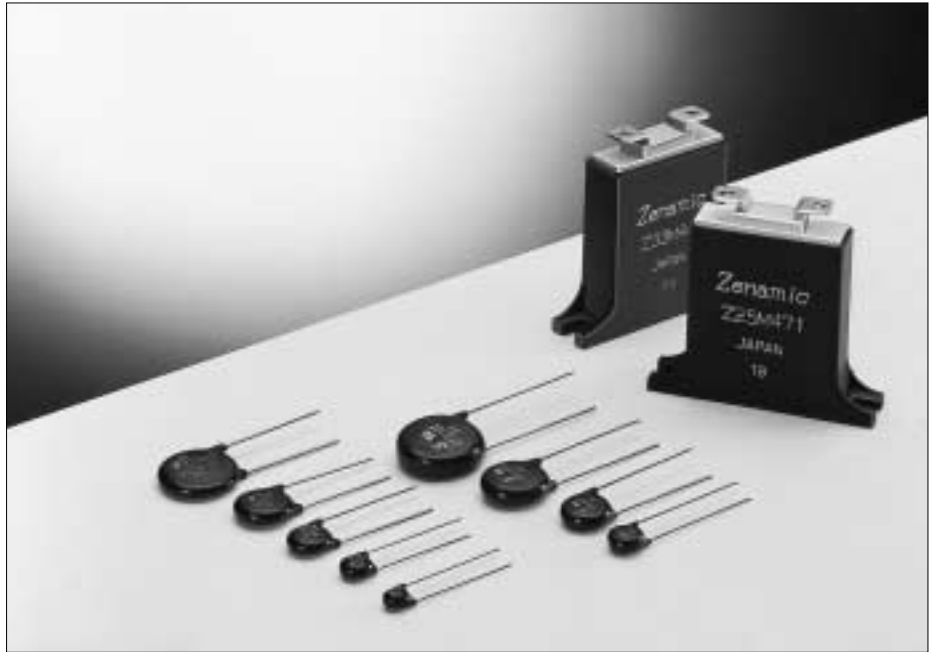

ZENAMIC is the product name of a metal oxide varistor. ZENAMIC Transient/ Surge Absorber, Series D is newly released through our continued research in ceramic material composition of ZnO varistor and manufacturing process, featuring large surge current handling capability and energy handling capability for absorbing transient overvoltage in compact size.

Features

- Improved in "Surge Current Handling Capability (@8/20 μ s, 2 times)" by about 2 times over the current.
- Very large "Energy Handling Capability" absorbing transient overvoltages in compact sizes.
- Lower Clamping Voltage for better surge protection.
- Fast response to high speed transient/ surge voltage.
- Wide products range for transient/ surge protection on AC 100V to AC 480V nominal system with the maximum peak current ratings of 600A to 7000A (@8/20 μ s, 2 times).

V-I characteristics

ZENAMIC has the forward-reverse symmetrical electrical characteristics as shown in the figure 1. The voltage-current curves show the varistor characteristics in the range 1μA to 10⁴A, and show the resistance characteristics for the range under 1μA and over 10⁴A in the figure 2. The voltage across terminals when test current(I_t: 1 mA) is applied to ZENAMIC is the standard varistor voltage(V_Z), and the voltage across terminals when a standard surge(I_p) is applied represents the maximum suppression voltage(V_C).

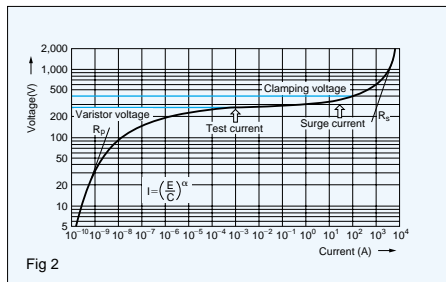
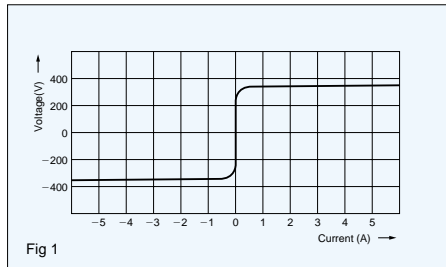

Temperature characteristics

In the small current range, ZENAMIC features outstanding temperature characteristics. A shunt resistance R_p of metal oxide varistor has the temperature characteristics which is determined by the following equation.

$$R_p = A_e E_g / 2kT \quad (2)$$

T: Absolute temperature
k: Boltzmann constant
A, E_g: constants

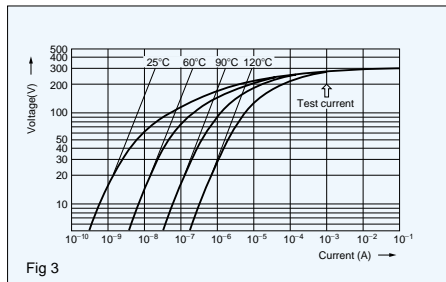

As shown in the figure 3, the temperature dependence characteristics are shown clearly in the low current area.

Surge waveform

A surge waveform varies according to the sources. An EXP waveform is used for surge testing of ZENAMIC, while a AC half-wave is used for the energy absorption test. The EXP waveform reaches its peak voltage (current) at [t_a] as shown in the figure 5, and then decreases as time passes and reaches half of the peak voltage (current) at [t_b]. This type of the EXP waveform is shown as a [t_a/t_b] voltage (current) waveform. For surge testing of ZENAMIC, the 8/20μ sec current waveform is used.

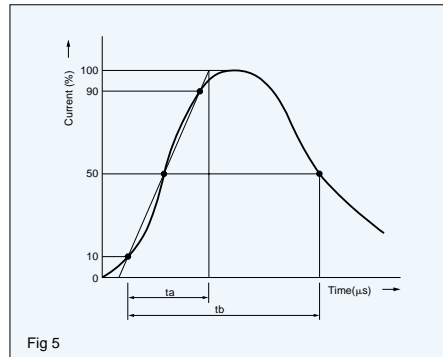

Part No.

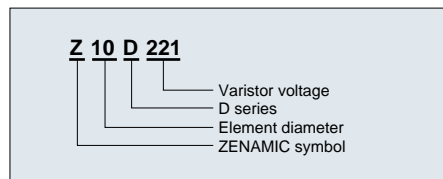

Application notes(General)

1. A surge excess of the specified Maximum Peak Current may cause short circuit or mechanical damage. The following measures are recommended.
 - In case that ZENAMIC is used in line to ground, the ground fault circuit interrupter shall be applied in location A or thermally coupled fuse shall be applied in location C.
 - ZENAMIC shall not be used near heat generating device and free from direct sunlight.
 - ZENAMIC shall not be used near the flammable materials.

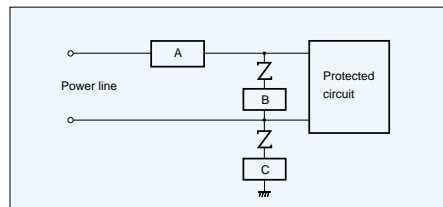

- 1) Location of the over current protector(circuit breaker or current fuse) shall be in the power line to the circuit(Location A) or in series with ZENAMIC (Location B).
- 2) It is recommended that a fuse listed in the table be put in location A or B.
- 3) In case that ZENAMIC is used in line to ground, the ground fault circuit interrupter should be applied in location A or thermally coupled fuse should be applied in location C.

| | | | |
|----------------|---------|---------|---------|
| Part Number | Z5D□□□ | Z7D□□□ | Z10D□□□ |
| Rating of fuse | 3A max. | 5A max. | 7A max. |

| | | |
|----------------|----------|----------|
| Part Number | Z15D□□□ | Z21D□□□ |
| Rating of fuse | 10A max. | 15A max. |

Refer to the related Safety Standards.

Applications

Power lines and surge absorption units with error display (SA series).

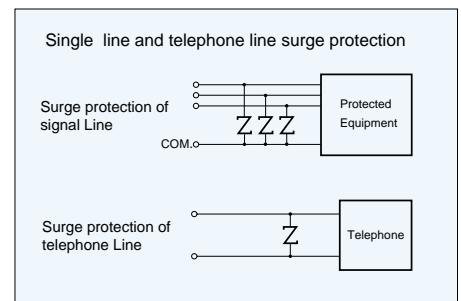
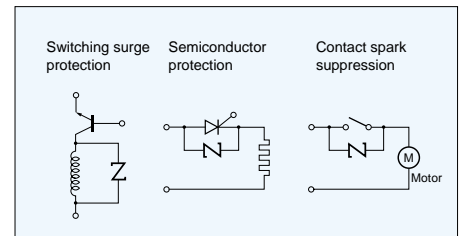
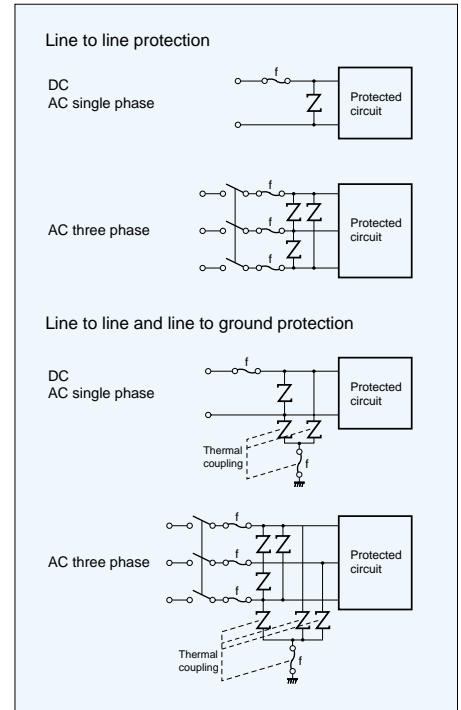

Z5D Series

Specifications

| Part No. | Varistor Voltage | Maximum Allowable Voltage | | Clamping Voltage (max.) | Rated Power | Maximum Energy | | Maximum Peak Current (8/20 μ s) | | Capacitance (max.) 1kHz |
|-----------|------------------------|---------------------------|-------|-------------------------|-------------|-------------------|-------|-------------------------------------|---------|-------------------------|
| | | | | | | (10/1000 μ s) | (2ms) | 1 time | 2 times | |
| | | | | | | (J) | (J) | (A) | (A) | |
| | V _{0.1mA} (V) | AC _{rms} (V) | DC(V) | V(V) | (W) | (J) | (J) | (A) | (A) | (pF) |
| Z5D180 | 18(16-20) | 11 | 14 | 40 at 1A | 0.01 | 0.6 | 0.4 | 250 | 125 | 1600 |
| Z5D220 | 22(20-24) | 14 | 18 | 48 | 0.01 | 0.7 | 0.5 | 250 | 125 | 1500 |
| Z5D270 | 27(24-30) | 17 | 22 | 60 | 0.01 | 0.9 | 0.7 | 250 | 125 | 1450 |
| Z5D330 | 33(30-36) | 20 | 26 | 73 | 0.01 | 1.1 | 0.8 | 250 | 125 | 1400 |
| Z5D390 | 39(35-43) | 25 | 31 | 86 | 0.01 | 1.2 | 0.9 | 250 | 125 | 700 |
| Z5D470 | 47(42-52) | 30 | 38 | 104 | 0.01 | 1.5 | 1.1 | 250 | 125 | 650 |
| Z5D560 | 56(50-62) | 35 | 45 | 123 | 0.01 | 1.8 | 1.3 | 250 | 125 | 600 |
| Z5D680 | 68(61-75) | 40 | 56 | 150 | 0.01 | 2.2 | 1.6 | 250 | 125 | 580 |
| *1 Z5D820 | 82(74-90) | 50 | 65 | 145 at 5A | 0.1 | 3.5 | 2.5 | 800 | 600 | 460 |
| *1 Z5D101 | 100(90-110) | 60 | 85 | 175 | 0.1 | 4.0 | 3.0 | 800 | 600 | 400 |
| *1 Z5D121 | 120(108-132) | 75 | 100 | 210 | 0.1 | 5.0 | 3.5 | 800 | 600 | 350 |
| *1 Z5D151 | 150(135-165) | 95 | 125 | 260 | 0.1 | 6.5 | 4.5 | 800 | 600 | 300 |
| *1 Z5D201 | 200(185-225) | 130 | 170 | 355 | 0.1 | 8.5 | 6.0 | 800 | 600 | 120 |
| *1 Z5D221 | 220(198-242) | 140 | 180 | 380 | 0.1 | 9.0 | 6.5 | 800 | 600 | 110 |
| *1 Z5D241 | 240(216-264) | 150 | 200 | 415 | 0.1 | 10.5 | 7.5 | 800 | 600 | 100 *2 |
| *1 Z5D271 | 270(247-303) | 175 | 225 | 475 | 0.1 | 11.0 | 8.0 | 800 | 600 | 90 *2 |
| *1 Z5D331 | 330(297-363) | 210 | 270 | 570 | 0.1 | 13.0 | 9.5 | 800 | 600 | 80 *2 |
| *1 Z5D361 | 360(324-396) | 230 | 300 | 620 | 0.1 | 16.0 | 11.0 | 800 | 600 | 80 *2 |
| *1 Z5D391 | 390(351-429) | 250 | 320 | 675 | 0.1 | 17.0 | 12.0 | 800 | 600 | 80 *2 |
| *1 Z5D431 | 430(387-473) | 275 | 350 | 754 | 0.1 | 20.0 | 13.0 | 800 | 600 | 70 *2 |
| *1 Z5D471 | 470(423-517) | 300 | 385 | 810 | 0.1 | 21.0 | 15.0 | 800 | 600 | 60 *2 |

Z7D Series

Specifications

| Part No. | Varistor Voltage | Maximum Allowable Voltage | | Clamping Voltage (max.) | Rated Power | Maximum Energy | | Maximum Peak Current (8/20 μ s) | | Capacitance (max.) 1kHz |
|-----------|----------------------|---------------------------|-------|-------------------------|-------------|-------------------|-------|-------------------------------------|---------|-------------------------|
| | | | | | | (10/1000 μ s) | (2ms) | 1 time | 2 times | |
| | | | | | | (J) | (J) | (A) | (A) | |
| | V _{1mA} (V) | AC _{rms} (V) | DC(V) | V(V) | (W) | (J) | (J) | (A) | (A) | (pF) |
| Z7D180 | 18(16-20) | 11 | 14 | 36 at 2.5A | 0.02 | 1.1 | 0.9 | 500 | 250 | 3800 |
| Z7D220 | 22(20-24) | 14 | 18 | 43 | 0.02 | 1.3 | 1.1 | 500 | 250 | 3600 |
| Z7D270 | 27(24-30) | 17 | 22 | 53 | 0.02 | 1.6 | 1.3 | 500 | 250 | 3400 |
| Z7D330 | 33(30-36) | 20 | 26 | 65 | 0.02 | 2.0 | 1.6 | 500 | 250 | 2900 |
| Z7D390 | 39(35-43) | 25 | 31 | 77 | 0.02 | 2.4 | 1.9 | 500 | 250 | 1600 |
| Z7D470 | 47(42-52) | 30 | 38 | 93 | 0.02 | 2.8 | 2.3 | 500 | 250 | 1550 |
| Z7D560 | 56(50-62) | 35 | 45 | 110 | 0.02 | 3.4 | 2.7 | 500 | 250 | 1500 |
| Z7D680 | 68(61-75) | 40 | 56 | 135 | 0.02 | 4.1 | 3.3 | 500 | 250 | 1200 |
| *1 Z7D820 | 82(74-90) | 50 | 65 | 135 at 10A | 0.25 | 7 | 5 | 1750 | 1250 | 810 |
| *1 Z7D101 | 100(90-110) | 60 | 85 | 165 | 0.25 | 8.5 | 6 | 1750 | 1250 | 700 |
| *1 Z7D121 | 120(108-132) | 75 | 100 | 200 | 0.25 | 10 | 7 | 1750 | 1250 | 590 |
| *1 Z7D151 | 150(135-165) | 95 | 125 | 250 | 0.25 | 13 | 9 | 1750 | 1250 | 500 |
| *1 Z7D201 | 200(185-225) | 130 | 170 | 340 | 0.25 | 17.5 | 12.5 | 1750 | 1250 | 200 |
| *1 Z7D221 | 220(198-242) | 140 | 180 | 360 | 0.25 | 19 | 13.5 | 1750 | 1250 | 190 |
| *1 Z7D241 | 240(216-264) | 150 | 200 | 395 | 0.25 | 21 | 15 | 1750 | 1250 | 170 |
| *1 Z7D271 | 270(247-303) | 175 | 225 | 455 | 0.25 | 24 | 17 | 1750 | 1250 | 150 |
| *1 Z7D331 | 330(297-363) | 210 | 270 | 545 | 0.25 | 28 | 20 | 1750 | 1250 | 130 |
| *1 Z7D361 | 360(324-396) | 230 | 300 | 595 | 0.25 | 32 | 23 | 1750 | 1250 | 130 |
| *1 Z7D391 | 390(351-429) | 250 | 320 | 650 | 0.25 | 35 | 25 | 1750 | 1250 | 130 |
| *1 Z7D431 | 430(387-473) | 275 | 350 | 710 | 0.25 | 40 | 27.5 | 1750 | 1250 | 120 |
| *1 Z7D471 | 470(423-517) | 300 | 385 | 775 | 0.25 | 42 | 30 | 1750 | 1250 | 100 *2 |
| *1 Z7D511 | 510(459-561) | 320 | 410 | 845 | 0.25 | 45 | 32 | 1750 | 1250 | 90 *2 |

1. Operating temperature range: -40 to 85°C
 2. Storage temperature range: -40 to 125°C
- *1 UL 1449 approved model
*2 Measured at 1MHz

Z10D Series

Specifications

| Part No. | Varistor Voltage | Maximum Allowable Voltage | | Clamping Voltage (max.) | Rated Power | Maximum Energy | | Maximum Peak Current (8/20 μ s) | | Capacitance (max.) 1kHz |
|-----------|----------------------|---------------------------|-------|-------------------------|-------------|-------------------|-------|-------------------------------------|---------|-------------------------|
| | | | | | | (10/1000 μ s) | (2ms) | 1 time | 2 times | |
| | | | | | | (J) | (J) | (A) | (A) | |
| | V _{1mA} (V) | AC _{rms} (V) | DC(V) | V(V) | (W) | (J) | (J) | (A) | (A) | (pF) |
| Z10D180 | 18(16-20) | 11 | 14 | 36 at 5A | 0.05 | 2.6 | 2.2 | 1000 | 500 | 16000 |
| Z10D220 | 22(20-24) | 14 | 18 | 43 | 0.05 | 3.2 | 2.6 | 1000 | 500 | 11000 |
| Z10D270 | 27(24-30) | 17 | 22 | 53 | 0.05 | 3.9 | 3.2 | 1000 | 500 | 8000 |
| Z10D330 | 33(30-36) | 20 | 26 | 65 | 0.05 | 4.8 | 4.0 | 1000 | 500 | 6300 |
| Z10D390 | 39(35-43) | 25 | 31 | 77 | 0.05 | 5.6 | 4.7 | 1000 | 500 | 5200 |
| Z10D470 | 47(42-52) | 30 | 38 | 93 | 0.05 | 6.8 | 5.6 | 1000 | 500 | 4600 |
| Z10D560 | 56(50-62) | 35 | 45 | 110 | 0.05 | 8.1 | 6.7 | 1000 | 500 | 3750 |
| Z10D680 | 68(61-75) | 40 | 56 | 135 | 0.05 | 9.8 | 8.2 | 1000 | 500 | 2800 |
| * Z10D820 | 82(74-90) | 50 | 65 | 135 at 25A | 0.4 | 14 | 10 | 3500 | 2500 | 2000 |
| * Z10D101 | 100(90-110) | 60 | 85 | 165 | 0.4 | 17 | 12 | 3500 | 2500 | 1700 |
| * Z10D121 | 120(108-132) | 75 | 100 | 200 | 0.4 | 20 | 14.5 | 3500 | 2500 | 1400 |
| * Z10D151 | 150(135-165) | 95 | 125 | 250 | 0.4 | 25 | 18 | 3500 | 2500 | 1100 |
| * Z10D201 | 200(185-225) | 130 | 170 | 340 | 0.4 | 35 | 25 | 3500 | 2500 | 430 |
| * Z10D221 | 220(198-242) | 140 | 180 | 360 | 0.4 | 39 | 27.5 | 3500 | 2500 | 410 |
| * Z10D241 | 240(216-264) | 150 | 200 | 395 | 0.4 | 42 | 30 | 3500 | 2500 | 380 |
| * Z10D271 | 270(247-303) | 175 | 225 | 455 | 0.4 | 49 | 35 | 3500 | 2500 | 350 |
| * Z10D331 | 330(297-363) | 210 | 270 | 545 | 0.4 | 58 | 42 | 3500 | 2500 | 300 |
| * Z10D361 | 360(324-396) | 230 | 300 | 595 | 0.4 | 65 | 45 | 3500 | 2500 | 300 |
| * Z10D391 | 390(351-429) | 250 | 320 | 650 | 0.4 | 70 | 50 | 3500 | 2500 | 300 |
| * Z10D431 | 430(387-473) | 275 | 350 | 710 | 0.4 | 80 | 55 | 3500 | 2500 | 270 |
| * Z10D471 | 470(423-517) | 300 | 385 | 775 | 0.4 | 85 | 60 | 3500 | 2500 | 230 |
| * Z10D511 | 510(459-561) | 320 | 410 | 845 | 0.4 | 92 | 67 | 3500 | 2500 | 210 |
| * Z10D561 | 560(504-616) | 350 | 450 | 930 | 0.4 | 92 | 67 | 3500 | 2500 | 200 |
| * Z10D681 | 680(612-748) | 420 | 560 | 1120 | 0.4 | 92 | 67 | 3500 | 2500 | 170 |
| * Z10D751 | 750(675-825) | 460 | 615 | 1240 | 0.4 | 100 | 70 | 3500 | 2500 | 160 |
| * Z10D821 | 820(738-902) | 510 | 670 | 1355 | 0.4 | 110 | 80 | 3500 | 2500 | 140 |
| * Z10D911 | 910(819-1001) | 550 | 745 | 1500 | 0.4 | 130 | 90 | 3500 | 2500 | 120 |
| * Z10D102 | 1000(900-1100) | 625 | 825 | 1650 | 0.4 | 140 | 100 | 3500 | 2500 | 110 |

Z15D Series

Specifications

| Part No. | Varistor Voltage | Maximum Allowable Voltage | | Clamping Voltage (max.) | Rated Power | Maximum Energy | | Maximum Peak Current (8/20 μ s) | | Capacitance (max.) 1kHz |
|-----------|----------------------|---------------------------|-------|-------------------------|-------------|-------------------|-------|-------------------------------------|---------|-------------------------|
| | | | | | | (10/1000 μ s) | (2ms) | 1 time | 2 times | |
| | | | | | | (J) | (J) | (A) | (A) | |
| | V _{1mA} (V) | AC _{rms} (V) | DC(V) | V(V) | (W) | (J) | (J) | (A) | (A) | (pF) |
| Z15D180 | 18(16-20) | 11 | 14 | 36 at 10A | 0.1 | 5.2 | 4.3 | 2000 | 1000 | 25000 |
| Z15D220 | 22(20-24) | 14 | 18 | 43 | 0.1 | 6.3 | 5.3 | 2000 | 1000 | 20000 |
| Z15D270 | 27(24-30) | 17 | 22 | 53 | 0.1 | 7.8 | 6.5 | 2000 | 1000 | 16000 |
| Z15D330 | 33(30-36) | 20 | 26 | 65 | 0.1 | 9.5 | 7.9 | 2000 | 1000 | 12200 |
| Z15D390 | 39(35-43) | 25 | 31 | 77 | 0.1 | 11 | 9.4 | 2000 | 1000 | 7000 |
| Z15D470 | 47(42-52) | 30 | 38 | 93 | 0.1 | 14 | 11 | 2000 | 1000 | 6750 |
| Z15D560 | 56(50-62) | 35 | 45 | 110 | 0.1 | 16 | 13 | 2000 | 1000 | 6500 |
| Z15D680 | 68(61-75) | 40 | 56 | 135 | 0.1 | 20 | 16 | 2000 | 1000 | 5500 |
| * Z15D820 | 82(74-90) | 50 | 65 | 135 at 50A | 0.6 | 28 | 20 | 6000 | 4500 | 3700 |
| * Z15D101 | 100(90-110) | 60 | 85 | 165 | 0.6 | 35 | 25 | 6000 | 4500 | 3200 |
| * Z15D121 | 120(108-132) | 75 | 100 | 200 | 0.6 | 42 | 30 | 6000 | 4500 | 2700 |
| * Z15D151 | 150(135-165) | 95 | 125 | 250 | 0.6 | 53 | 37.5 | 6000 | 4500 | 2200 |
| * Z15D201 | 200(185-225) | 130 | 170 | 340 | 0.6 | 70 | 50 | 6000 | 4500 | 770 |
| * Z15D221 | 220(198-242) | 140 | 180 | 360 | 0.6 | 78 | 55 | 6000 | 4500 | 740 |
| * Z15D241 | 240(216-264) | 150 | 200 | 395 | 0.6 | 84 | 60 | 6000 | 4500 | 700 |
| * Z15D271 | 270(247-303) | 175 | 225 | 455 | 0.6 | 99 | 70 | 6000 | 4500 | 640 |
| * Z15D331 | 330(297-363) | 210 | 270 | 545 | 0.6 | 115 | 80 | 6000 | 4500 | 580 |
| * Z15D361 | 360(324-396) | 230 | 300 | 595 | 0.6 | 130 | 90 | 6000 | 4500 | 540 |
| * Z15D391 | 390(351-429) | 250 | 320 | 650 | 0.6 | 140 | 100 | 6000 | 4500 | 500 |
| * Z15D431 | 430(387-473) | 275 | 350 | 710 | 0.6 | 155 | 110 | 6000 | 4500 | 450 |
| * Z15D471 | 470(423-517) | 300 | 385 | 775 | 0.6 | 175 | 125 | 6000 | 4500 | 400 |
| * Z15D511 | 510(459-561) | 320 | 410 | 845 | 0.6 | 190 | 136 | 6000 | 4500 | 350 |
| * Z15D561 | 560(504-616) | 350 | 450 | 930 | 0.6 | 190 | 136 | 6000 | 4500 | 340 |
| * Z15D681 | 680(612-748) | 420 | 560 | 1120 | 0.6 | 190 | 136 | 5000 | 4500 | 320 |
| * Z15D751 | 750(675-825) | 460 | 615 | 1240 | 0.6 | 210 | 150 | 5000 | 4500 | 310 |
| * Z15D821 | 820(738-902) | 510 | 670 | 1355 | 0.6 | 235 | 165 | 5000 | 4500 | 280 |
| * Z15D911 | 910(819-1001) | 550 | 745 | 1500 | 0.6 | 255 | 180 | 5000 | 4500 | 250 |
| * Z15D102 | 1000(900-1100) | 625 | 825 | 1650 | 0.6 | 280 | 200 | 5000 | 4500 | 230 |

1. Operating temperature range: -40 to 85°C
 2. Storage temperature range: -40 to 125°C
- * UL 1449 approved model

Z21D Series

Specifications

| Part No. | Varistor Voltage | Maximum Allowable Voltage | | Clamping Voltage (max.) | Rated Power | Maximum Energy | | Maximum Peak Current (8/20 μ s) | | Capacitance (max.) 1kHz |
|-----------|------------------|---------------------------|-------|-------------------------|-------------|-------------------|-------|-------------------------------------|---------|-------------------------|
| | | AC _{rms} (V) | DC(V) | | | (10/1000 μ s) | (2ms) | 1 time | 2 times | |
| | | | | | | | | | | |
| Z21D180 | 18(16-20) | 11 | 14 | 36 at 20A | 0.2 | 13 | 12 | 3000 | 2000 | 40000 |
| Z21D220 | 22(20-24) | 14 | 18 | 43 | 0.2 | 16 | 14 | 3000 | 2000 | 30000 |
| Z21D270 | 27(24-30) | 17 | 22 | 53 | 0.2 | 19 | 17 | 3000 | 2000 | 24500 |
| Z21D330 | 33(30-36) | 20 | 26 | 65 | 0.2 | 24 | 21 | 3000 | 2000 | 20000 |
| Z21D390 | 39(35-43) | 25 | 31 | 77 | 0.2 | 28 | 25 | 3000 | 2000 | 13800 |
| Z21D470 | 47(42-52) | 30 | 38 | 93 | 0.2 | 34 | 30 | 3000 | 2000 | 13500 |
| Z21D560 | 56(50-62) | 35 | 45 | 110 | 0.2 | 41 | 36 | 3000 | 2000 | 12200 |
| Z21D680 | 68(61-75) | 40 | 56 | 135 | 0.2 | 49 | 44 | 3000 | 2000 | 11500 |
| * Z21D820 | 82(74-90) | 50 | 65 | 135 at 100A | 1.0 | 56 | 40 | 10000 | 6500 | 7500 |
| * Z21D101 | 100(90-110) | 60 | 85 | 165 | 1.0 | 70 | 50 | 10000 | 6500 | 6500 |
| * Z21D121 | 120(108-132) | 75 | 100 | 200 | 1.0 | 85 | 60 | 10000 | 6500 | 5500 |
| * Z21D151 | 150(135-165) | 95 | 125 | 250 | 1.0 | 106 | 75 | 10000 | 6500 | 4500 |
| * Z21D201 | 200(185-225) | 130 | 170 | 340 | 1.0 | 140 | 100 | 10000 | 6500 | 1700 |
| * Z21D221 | 220(198-242) | 140 | 180 | 360 | 1.0 | 155 | 110 | 10000 | 6500 | 1600 |
| * Z21D241 | 240(216-264) | 150 | 200 | 395 | 1.0 | 168 | 120 | 10000 | 6500 | 1500 |
| * Z21D271 | 270(247-303) | 175 | 225 | 455 | 1.0 | 190 | 135 | 10000 | 6500 | 1300 |
| * Z21D331 | 330(297-363) | 210 | 270 | 545 | 1.0 | 228 | 160 | 10000 | 6500 | 1100 |
| * Z21D361 | 360(324-396) | 230 | 300 | 595 | 1.0 | 255 | 180 | 10000 | 6500 | 1100 |
| * Z21D391 | 390(351-429) | 250 | 320 | 650 | 1.0 | 275 | 195 | 10000 | 6500 | 1100 |
| * Z21D431 | 430(387-473) | 275 | 350 | 710 | 1.0 | 303 | 215 | 10000 | 6500 | 1000 |
| * Z21D471 | 470(423-517) | 300 | 385 | 775 | 1.0 | 350 | 250 | 10000 | 6500 | 900 |
| * Z21D511 | 510(459-561) | 320 | 410 | 845 | 1.0 | 382 | 273 | 10000 | 6500 | 800 |
| * Z21D561 | 560(504-616) | 350 | 450 | 930 | 1.0 | 382 | 273 | 7500 | 6500 | 750 |
| * Z21D681 | 680(612-748) | 420 | 560 | 1120 | 1.0 | 382 | 273 | 7500 | 6500 | 650 |
| * Z21D751 | 750(675-825) | 460 | 615 | 1240 | 1.0 | 420 | 300 | 7500 | 6500 | 600 |
| * Z21D821 | 820(738-902) | 510 | 670 | 1355 | 1.0 | 460 | 325 | 7500 | 6500 | 530 |
| * Z21D911 | 910(819-1001) | 550 | 745 | 1500 | 1.0 | 510 | 360 | 7500 | 6500 | 500 |
| * Z21D102 | 1000(900-1100) | 625 | 825 | 1650 | 1.0 | 565 | 400 | 7500 | 6500 | 450 |

1. Operating temperature range: -40 to 85°C * UL 1449 approved model
 2. Storage temperature range: -40 to 125°C

Dimensions

Z5D

Z7D

Z10D

Z15D

Z21D

Crimped Leads and Taped
 Z5D □□□ T4C
 Z7D □□□ T4C

Straight Leads and Taped
 Z5D □□□ T4D
 Z7D □□□ T4D

*Dimension "T": Conforms to each individual specification
 *Packing quantity: 1000pcs/BOX

| Symbol | Type I | Symbol | Type I |
|----------------|--|-----------------|------------|
| P | 12.7±1.0 | W ₀ | 5.0min |
| P ₀ | 12.7±0.3 | W ₁ | 9.0±0.5 |
| P ₁ | 3.85±0.70 | W ₂ | 3max |
| P ₂ | 6.35±1.30 | H | Approx. 20 |
| φd | 0.60 ^{+0.08} _{-0.05} | H ₀ | 17.0±0.5 |
| F | 5.0±0.5 | φD ₀ | φ4.0±0.2 |
| Δh | 0±2 | t | 0.6±0.3 |
| W | 18.0 ^{+1.0} _{-0.5} | L | 11max |
| φD | Z5D: 7max, Z7D: 8.5max | | |

*Dimension "T": Conforms to each individual specification
 *Packing quantity: 1000pcs/BOX

| Symbol | Type I | Symbol | Type I |
|----------------|--|-----------------|------------|
| P | 12.7±1.0 | W ₀ | 5.0min |
| P ₀ | 12.7±0.3 | W ₁ | 9.0±0.5 |
| P ₁ | 3.85±0.70 | W ₂ | 3max |
| P ₂ | 6.35±1.30 | H | Approx. 20 |
| φd | 0.60 ^{+0.08} _{-0.05} | H ₀ | 17.0±0.5 |
| F | 5.0±0.5 | φD ₀ | φ4.0±0.2 |
| Δh | 0±2 | t | 0.6±0.3 |
| W | 18.0 ^{+1.0} _{-0.5} | L | 11max |
| φD | Z5D: 7max, Z7D: 8.5max | | |

Unit(mm)

Z25M, Z33M Series Specifications

| Part No. | Varistor voltage $V_{1mA}(V)$ | | Maximum allowable voltage | | Maximum clamping voltage | Rated wattage | Energy (2ms) | Withstanding Surge current (8/20 μ s) | | Typical capacitance (@ 1kHz) |
|----------|-------------------------------|-----|---------------------------|-----|--------------------------|---------------|--------------|---|---------|------------------------------|
| | | | AC | DC | | | | 1 Time | 2 Times | |
| | Min | Max | V_{rms} | V | V | W | J | | | pF |
| Z25M221S | 220(187 ~253) | | 120 | 165 | 380 at 150A | | 125 | | | 3300 |
| Z25M271S | 270(229.5~310.5) | | 150 | 210 | 465 | | 155 | | | 2200 |
| Z25M331S | 330(280.5~379.5) | | 175 | 245 | 570 | | 185 | | | 1900 |
| Z25M391S | 390(331.5~448.5) | | 210 | 295 | 675 | | 215 | | | 1700 |
| Z25M441S | 440(374 ~506) | | 240 | 335 | 760 | | 225 | | | 1500 |
| Z25M471S | 470(399.5~540.5) | | 250 | 350 | 810 | 1.0 | 235 | 15000A | 10000A | 1500 |
| Z25M561S | 560(476 ~644) | | 300 | 420 | 970 | | 260 | | | 1400 |
| Z25M681S | 680(578 ~782) | | 365 | 510 | 1175 | | 280 | | | 1250 |
| Z25M821S | 820(697 ~943) | | 440 | 615 | 1415 | | 330 | | | 800 |
| Z25M102S | 1000(850 ~1,150) | | 520 | 730 | 1725 | | 375 | | | 500 |
| Z33M221S | 220(187 ~253) | | 120 | 165 | 380 at 200A | | 200 | | | 5500 |
| Z33M271S | 270(229.5~310.5) | | 150 | 210 | 465 | | 255 | | | 4200 |
| Z33M331S | 330(280.5~379.5) | | 175 | 245 | 570 | | 310 | | | 3700 |
| Z33M391S | 390(331.5~448.5) | | 210 | 295 | 675 | | 360 | | | 3200 |
| Z33M441S | 440(374 ~506) | | 240 | 335 | 760 | | 370 | | | 2800 |
| Z33M471S | 470(399.5~540.5) | | 250 | 350 | 810 | 1.2 | 385 | 25000A | 20000A | 2600 |
| Z33M561S | 560(476 ~644) | | 300 | 420 | 970 | | 425 | | | 2200 |
| Z33M681S | 680(578 ~782) | | 365 | 510 | 1175 | | 460 | | | 1800 |
| Z33M821S | 820(697 ~943) | | 440 | 615 | 1415 | | 580 | | | 1500 |
| Z33M102S | 1000(850 ~1150) | | 520 | 730 | 1725 | | 620 | | | 1000 |

- Operating temperature range: -40 to 85°C
- Storage temperature range: -40 to 125°C

Dimensions

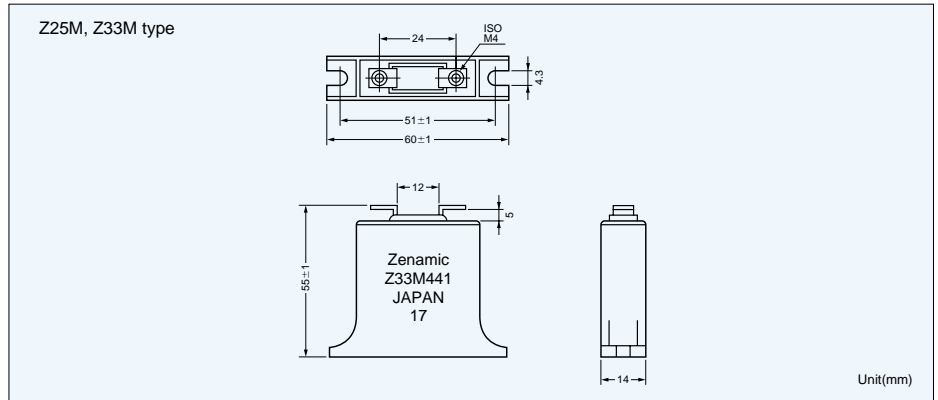

SURGE ABSORBER UNIT

The said unit is connected to line and ground, and protects an electric appliance from the surge influence. When the unit was broken by the surge of over rated current, it shows trouble in lighting LED. The socket of exclusive use for the unit, shown in right side figure, is also suppliable.

Specifications table SA series

| Line voltage | Part No. | Rating voltage | | Rating current | |
|--------------|----------|--------------------|--|----------------|-------------|
| | | line-line | ground-line | line-line | ground-line |
| | | V | V | A | A |
| 48V DC | SA- 50V | 65V _{DC} | 180V _{DC} or 140V _{DC} | 1250 | 1500 |
| 100V AC | SA-100V | 140V _{AC} | 240V _{AC} | 1250 | 1250 |
| 200V AC | SA-200V | 250V _{AC} | 510V _{AC} | 1250 | 1500 |
| 240V AC | SA-240V | 300V _{AC} | 510V _{AC} | 1250 | 1500 |

Clamping voltage is measured by ()V peak voltage wave with line impedance of 50 Ω

Dimensions

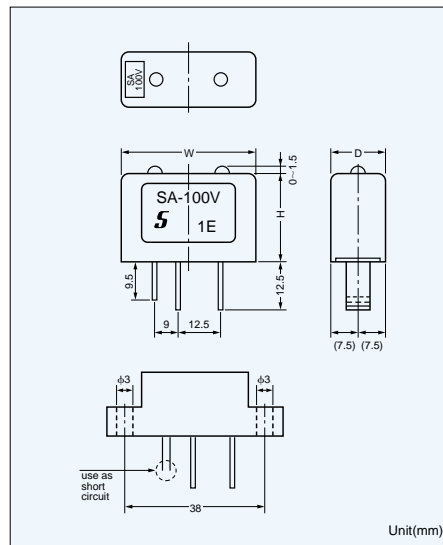

| Part No. | W | D | H |
|---------------|------------|--------------|------------|
| SA-50V, 100V | 40 \pm 1 | 15 \pm 0.2 | 30 \pm 1 |
| SA-200V, 240V | 40 \pm 1 | 18 \pm 1 | 35 \pm 1 |

(mm)

Application

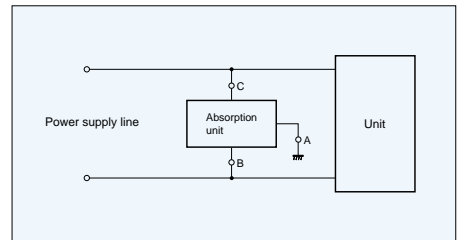

ZENAMIC
Reliability

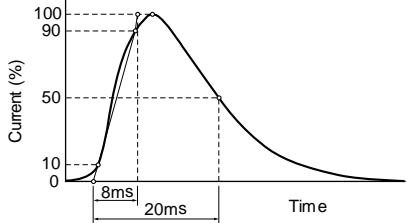
| Characteristics | | Test Methods/Descriptions | Criterion | | | | | | | | | | | | | | | | | | | | | | | | | | | | | | | | | | | | | | |
|---|------------------------|---|--|-----------------------------|-------------------------------------|------------------------|----------------------------------|-----------|---------------------|--|--------------------|-----------|-----------|--------------------|------------|------------|--------------------|------------|------------|--------------------|------------|------------|--------------------|-------------|------------|--------------------|------------|------------|--------------------|-------------|------------|--------------------|-------------|------------|--------------------|-------------|-------------|--------------------|-------------|-------------|--|
| Standard Test Condition | | Unless other wise specified, electrical measurements (initial/aftertests) shall be conducted at temperature of 5 to 35°C, relative humidity of 45 to 85% and atmospheric pressure of 860 to 1060 hPa. | | | | | | | | | | | | | | | | | | | | | | | | | | | | | | | | | | | | | | | |
| Varistor Voltage | | The voltage between two terminals with the specified measuring current C_{mA} DC applied is called V_C or V_{CmA} . The measurement shall be made as fast as possible to avoid heat affection. | | | | | | | | | | | | | | | | | | | | | | | | | | | | | | | | | | | | | | | |
| Maximum Allowable Voltage | | The maximum sinusoidal RMS voltage or maximum DC voltage that can be applied continuously in the specified operating temperature range. | | | | | | | | | | | | | | | | | | | | | | | | | | | | | | | | | | | | | | | |
| Clamping Voltage | | <p>The maximum voltage between two terminals with the specified standard impulse current (8/20μs) illustrated below applied.</p>  | To meet the specified value. | | | | | | | | | | | | | | | | | | | | | | | | | | | | | | | | | | | | | | |
| Rated Power | | The power that can be applied in the specified ambient temperature. | | | | | | | | | | | | | | | | | | | | | | | | | | | | | | | | | | | | | | | |
| Maximum Energy | | The maximum energy within the varistor voltage change of ±10% when a single impulse current of 2 ms or 10/1000μs is applied. | | | | | | | | | | | | | | | | | | | | | | | | | | | | | | | | | | | | | | | |
| Maximum Peak Current (Withstanding Surge Current) | 2 times | The maximum current within the varistor voltage change of ±10% when a standard impulse current of 8/20μs is applied two times with an interval of 5 minutes. | | | | | | | | | | | | | | | | | | | | | | | | | | | | | | | | | | | | | | | |
| | 1 times | The maximum current within the varistor voltage change of ±10% with a single standard impulse current of 8/20μs is applied. | | | | | | | | | | | | | | | | | | | | | | | | | | | | | | | | | | | | | | | |
| Temperature Coefficient of Varistor Voltage | | $\frac{V_{CmA} \text{ at } 85^{\circ}\text{C} - V_{CmA} \text{ at } 25^{\circ}\text{C}}{V_{CmA} \text{ at } 25^{\circ}\text{C}} \times \frac{1}{60} \times 100 (\%/^{\circ}\text{C})$ | | 0 to -0.05% / °C max. | | | | | | | | | | | | | | | | | | | | | | | | | | | | | | | | | | | | | |
| Capacitance | | Capacitance shall be measured at 1kHz ±10%, 1Vrms max.(1MHz±10% below 100pF), 0 V bias and 20±2°C | | To meet the specified value | | | | | | | | | | | | | | | | | | | | | | | | | | | | | | | | | | | | | |
| Withstanding Voltage (Body Insulation) | | <p>The specified voltage shall be applied between both terminals of the specimen connected together and metal foil closely wrapped round its body for 1 minute.</p> <table border="1" data-bbox="568 1330 1209 1425"> <thead> <tr> <th>Classification(Nominal varistor voltage)</th> <th>Test voltage(AC)</th> </tr> </thead> <tbody> <tr> <td>$V_{0.1mA} \cdot V_{1mA} \leq 330V$</td> <td>1000 Vrms</td> </tr> <tr> <td>$V_{0.1mA} \cdot V_{1mA} > 330V$</td> <td>1500 Vrms</td> </tr> </tbody> </table> | Classification(Nominal varistor voltage) | Test voltage(AC) | $V_{0.1mA} \cdot V_{1mA} \leq 330V$ | 1000 Vrms | $V_{0.1mA} \cdot V_{1mA} > 330V$ | 1500 Vrms | No breakdown | | | | | | | | | | | | | | | | | | | | | | | | | | | | | | | | |
| Classification(Nominal varistor voltage) | Test voltage(AC) | | | | | | | | | | | | | | | | | | | | | | | | | | | | | | | | | | | | | | | | |
| $V_{0.1mA} \cdot V_{1mA} \leq 330V$ | 1000 Vrms | | | | | | | | | | | | | | | | | | | | | | | | | | | | | | | | | | | | | | | | |
| $V_{0.1mA} \cdot V_{1mA} > 330V$ | 1500 Vrms | | | | | | | | | | | | | | | | | | | | | | | | | | | | | | | | | | | | | | | | |
| Impulse Life | | <p>The change of V_{CmA} shall be measured after the impulse current listed below is applied 10000 or 100000 times continuously at intervals of 10 seconds at room temperature.</p> <table border="1" data-bbox="568 1521 1209 1915"> <thead> <tr> <th rowspan="2">Part NO.</th> <th>Impulse Life(I)</th> <th>Impulse Life(II)</th> </tr> <tr> <th>×10⁴ Times</th> <th>×10⁵ Times</th> </tr> <tr> <th></th> <th colspan="2">impulse current (A)</th> </tr> </thead> <tbody> <tr> <td>Z 5D180 to Z 5D680</td> <td>8(8/20μs)</td> <td>5(8/20μs)</td> </tr> <tr> <td>Z 7D180 to Z 7D680</td> <td>25(8/20μs)</td> <td>15(8/20μs)</td> </tr> <tr> <td>Z10D180 to Z10D680</td> <td>50(8/20μs)</td> <td>35(8/20μs)</td> </tr> <tr> <td>Z15D180 to Z15D680</td> <td>90(8/20μs)</td> <td>50(8/20μs)</td> </tr> <tr> <td>Z21D180 to Z21D680</td> <td>130(8/20μs)</td> <td>65(8/20μs)</td> </tr> <tr> <td>Z 5D820 to Z 5D471</td> <td>40(8/20μs)</td> <td>25(8/20μs)</td> </tr> <tr> <td>Z 7D820 to Z 7D511</td> <td>100(8/20μs)</td> <td>60(8/20μs)</td> </tr> <tr> <td>Z10D820 to Z10D102</td> <td>150(8/20μs)</td> <td>85(8/20μs)</td> </tr> <tr> <td>Z15D820 to Z15D102</td> <td>200(8/20μs)</td> <td>110(8/20μs)</td> </tr> <tr> <td>Z21D820 to Z21D102</td> <td>250(8/20μs)</td> <td>120(8/20μs)</td> </tr> </tbody> </table> | Part NO. | Impulse Life(I) | Impulse Life(II) | ×10 ⁴ Times | ×10 ⁵ Times | | impulse current (A) | | Z 5D180 to Z 5D680 | 8(8/20μs) | 5(8/20μs) | Z 7D180 to Z 7D680 | 25(8/20μs) | 15(8/20μs) | Z10D180 to Z10D680 | 50(8/20μs) | 35(8/20μs) | Z15D180 to Z15D680 | 90(8/20μs) | 50(8/20μs) | Z21D180 to Z21D680 | 130(8/20μs) | 65(8/20μs) | Z 5D820 to Z 5D471 | 40(8/20μs) | 25(8/20μs) | Z 7D820 to Z 7D511 | 100(8/20μs) | 60(8/20μs) | Z10D820 to Z10D102 | 150(8/20μs) | 85(8/20μs) | Z15D820 to Z15D102 | 200(8/20μs) | 110(8/20μs) | Z21D820 to Z21D102 | 250(8/20μs) | 120(8/20μs) | $\Delta V_{CmA} / V_{CmA} \leq \pm 10\%$ |
| Part NO. | Impulse Life(I) | Impulse Life(II) | | | | | | | | | | | | | | | | | | | | | | | | | | | | | | | | | | | | | | | |
| | ×10 ⁴ Times | ×10 ⁵ Times | | | | | | | | | | | | | | | | | | | | | | | | | | | | | | | | | | | | | | | |
| | impulse current (A) | | | | | | | | | | | | | | | | | | | | | | | | | | | | | | | | | | | | | | | | |
| Z 5D180 to Z 5D680 | 8(8/20μs) | 5(8/20μs) | | | | | | | | | | | | | | | | | | | | | | | | | | | | | | | | | | | | | | | |
| Z 7D180 to Z 7D680 | 25(8/20μs) | 15(8/20μs) | | | | | | | | | | | | | | | | | | | | | | | | | | | | | | | | | | | | | | | |
| Z10D180 to Z10D680 | 50(8/20μs) | 35(8/20μs) | | | | | | | | | | | | | | | | | | | | | | | | | | | | | | | | | | | | | | | |
| Z15D180 to Z15D680 | 90(8/20μs) | 50(8/20μs) | | | | | | | | | | | | | | | | | | | | | | | | | | | | | | | | | | | | | | | |
| Z21D180 to Z21D680 | 130(8/20μs) | 65(8/20μs) | | | | | | | | | | | | | | | | | | | | | | | | | | | | | | | | | | | | | | | |
| Z 5D820 to Z 5D471 | 40(8/20μs) | 25(8/20μs) | | | | | | | | | | | | | | | | | | | | | | | | | | | | | | | | | | | | | | | |
| Z 7D820 to Z 7D511 | 100(8/20μs) | 60(8/20μs) | | | | | | | | | | | | | | | | | | | | | | | | | | | | | | | | | | | | | | | |
| Z10D820 to Z10D102 | 150(8/20μs) | 85(8/20μs) | | | | | | | | | | | | | | | | | | | | | | | | | | | | | | | | | | | | | | | |
| Z15D820 to Z15D102 | 200(8/20μs) | 110(8/20μs) | | | | | | | | | | | | | | | | | | | | | | | | | | | | | | | | | | | | | | | |
| Z21D820 to Z21D102 | 250(8/20μs) | 120(8/20μs) | | | | | | | | | | | | | | | | | | | | | | | | | | | | | | | | | | | | | | | |

ZENAMIC

Reliability

| Characteristics | | Test Methods | Criterion | | | | | | | | | | | | | | | |
|--------------------------------------|--|---|---------------------------------------|-----------------|-----------------|--------------|--------|---------------|---------------------------------|------------------|------|---|-------|------|---|------------------|------|--|
| Mechanical | Robustness of Terminations (Tensile) | <p>After gradual applying of the force specified below and keeping the unit fixed for 10 seconds, the terminal shall be visually examined for any damage.</p> <table border="1"> <thead> <tr> <th>Terminal diameter</th> <th>Force</th> </tr> </thead> <tbody> <tr> <td>φ0.6mm, φ0.8mm</td> <td>9.8N(1.0kgf)</td> </tr> <tr> <td>φ1.0mm</td> <td>19.6N(2.0kgf)</td> </tr> </tbody> </table> | Terminal diameter | Force | φ0.6mm, φ0.8mm | 9.8N(1.0kgf) | φ1.0mm | 19.6N(2.0kgf) | No remarkable mechanical damage | | | | | | | | | |
| | Terminal diameter | Force | | | | | | | | | | | | | | | | |
| | φ0.6mm, φ0.8mm | 9.8N(1.0kgf) | | | | | | | | | | | | | | | | |
| | φ1.0mm | 19.6N(2.0kgf) | | | | | | | | | | | | | | | | |
| | Robustness of Terminations (Bending) | <p>The unit shall be secured with its terminal kept vertical and the force specified below shall be applied in the axial direction. The terminal shall gradually be bent by 90° in one direction, then 90° in the opposite direction, and again back to the original position. The damage of the terminal shall be visually examined.</p> <table border="1"> <thead> <tr> <th>Terminal diameter</th> <th>Force</th> </tr> </thead> <tbody> <tr> <td>φ 0.6mm, φ0.8mm</td> <td>4.9N(0.5kgf)</td> </tr> <tr> <td>φ1.0mm</td> <td>9.8N(1.0kgf)</td> </tr> </tbody> </table> | Terminal diameter | Force | φ 0.6mm, φ0.8mm | 4.9N(0.5kgf) | φ1.0mm | 9.8N(1.0kgf) | | | | | | | | | | |
| Terminal diameter | Force | | | | | | | | | | | | | | | | | |
| φ 0.6mm, φ0.8mm | 4.9N(0.5kgf) | | | | | | | | | | | | | | | | | |
| φ1.0mm | 9.8N(1.0kgf) | | | | | | | | | | | | | | | | | |
| Vibration | <p>After repeated applying of a single harmonic vibration (amplitude:0.75mm, double amplitude:1.5mm) with 1 minute vibration frequency cycle (10 Hz to 55 Hz to 10Hz) to each of three perpendicular directions for 2 hours. Thereafter, the unit shall be visually examined.</p> | | | | | | | | | | | | | | | | | |
| Solderability | <p>After dipping the terminals to a depth of approximately 3 mm from the body in a soldering bath of 235±5°C for 2±0.5seconds, the terminal shall be visually examined.</p> | Approximately 95% of the terminals shall be covered uniformly with new solder | | | | | | | | | | | | | | | | |
| Resistance to Soldering Heat | <p>After each lead shall be dipped into a solder bath of 260±5°C to a point 2.0 to 2.5mm from the body of the unit, using shielding board (t=1.5mm), be held there for 10±1s (5 series:5±1s) and then be stored at room temperature and normal humidity for 1 to 2 hours. The change of V_{CmA} and mechanical damage shall be examined.</p> | $\Delta V_{CmA}/V_{CmA} \leq \pm 5\%$ No remarkable mechanical damage | | | | | | | | | | | | | | | | |
| Environmental | High Temperature Storage/Dry Heat | <p>The specimen shall be subjected to 125±2°C for 1000 hours in a thermostatic bath without load and then stored at room temperature and normal humidity for 1 to 2 hours. Thereafter, the change of V_{CmA} shall be measured.</p> | $\Delta V_{CmA}/V_{CmA} \leq \pm 5\%$ | | | | | | | | | | | | | | | |
| | Humidity (Steady State) | <p>The specimen shall be subjected to 40±2°C, 90 to 95% RH for 1000 hours without load and then stored at room temperature and normal humidity for 1 to 2 hours. Thereafter, the change of V_{CmA} shall be measured.</p> | $\Delta V_{CmA}/V_{CmA} \leq \pm 5\%$ | | | | | | | | | | | | | | | |
| | Temperature Cycle | <p>The following temperature cycle shall be repeated five times and then stored at room temperature and normal humidity for 1 to 2 hours. The change of V_{CmA} and mechanical damage shall be examined.</p> <table border="1"> <thead> <tr> <th>Step</th> <th>Temperature(°C)</th> <th>Period(minutes)</th> </tr> </thead> <tbody> <tr> <td>1</td> <td>-40±3</td> <td>30±3</td> </tr> <tr> <td>2</td> <td>Room temperature</td> <td>15±3</td> </tr> <tr> <td>3</td> <td>125±2</td> <td>30±3</td> </tr> <tr> <td>4</td> <td>Room temperature</td> <td>15±3</td> </tr> </tbody> </table> | Step | Temperature(°C) | Period(minutes) | 1 | -40±3 | 30±3 | 2 | Room temperature | 15±3 | 3 | 125±2 | 30±3 | 4 | Room temperature | 15±3 | $\Delta V_{CmA}/V_{CmA} \leq \pm 5\%$ No remarkable mechanical damage |
| | Step | Temperature(°C) | Period(minutes) | | | | | | | | | | | | | | | |
| | 1 | -40±3 | 30±3 | | | | | | | | | | | | | | | |
| | 2 | Room temperature | 15±3 | | | | | | | | | | | | | | | |
| 3 | 125±2 | 30±3 | | | | | | | | | | | | | | | | |
| 4 | Room temperature | 15±3 | | | | | | | | | | | | | | | | |
| High Temperature Load/ Dry Heat Load | <p>After being continuously applied the Maximum Allowable Voltage at 85±2°C for 1000 hours, the specimen shall be stored at room temperature and normal humidity for 1 to 2 hours. Thereafter, the change of V_{CmA} shall be measured.</p> | $\Delta V_{CmA}/V_{CmA} \leq \pm 10\%$ | | | | | | | | | | | | | | | | |
| Damp Heat Load/ Humidity Load | <p>The specimen shall be subjected to 40±2°C, 90 to 95% RH and the Maximum Allowable Voltage for 1000 hours and then stored at room temperature and normal humidity for 1 to 2 hours. Thereafter, the change of V_{CmA} shall be measured.</p> | $\Delta V_{CmA}/V_{CmA} \leq \pm 10\%$ | | | | | | | | | | | | | | | | |
| Low Temperature Storage/Cold | <p>The specimen shall be subjected to -40±2°C without load for 1000 hours and then stored at room temperature and normal humidity for 1 to 2 hours. Thereafter, the change of V_{CmA} shall be measured.</p> | $\Delta V_{CmA}/V_{CmA} \leq \pm 5\%$ | | | | | | | | | | | | | | | | |

GASTUBE ARRESTER

Gas tube arrester(GTA)is a surge absorber featuring low capacitance and high surge absorption energy.

It consists of a sealed tube in which inert gas is injected and electrodes which are set at fixed intervals. The simple structure and the dimensional accuracy offer high reliability and stabilized characteristics.

Applications

1. Protection for telephone set, facsimile, telex, telephone system, CATV, computer and peripheral equipment.
2. Semiconductor circuit protection in equipment that also uses high voltage such as TV, oscilloscope, and electron microscope.
3. Automatic control of luminous energy in stroboscopic tube.
4. Generator of high-voltage for gas igniter.

Voltage-Current Characteristics

The current through the GTA is changed over the range of values of 10^{-18} to 10^2 amps which is shown as the figure below and the voltage across the GTA will also vary. The discharge characteristics are changed to various mode by the flowing current, and the final mode of the discharge characteristics is arc discharge .

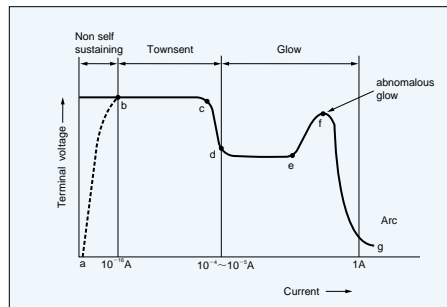

When the applied voltage across the GTA exceeds the breakdown voltage (sparkover voltage), the current through the GTA increases rapidly to value of several amps or greater. The rate of current rise and level to be reached are limited by the series impedance of the circuit. The voltage across the GTA at this time is very low with typical value of 20 to 30 volts.

Electrical Characteristics

AC Discharge Current

The current is the rms value of sinusoidal alternating current of 50Hz or 60Hz which can flow through the GTA in accordance with a certain test method without substantially altering its sparkover voltage. The usual test consists of specified loads applied for 1 sec at interval of 1 min alternately. In the test of the maximum AC discharge current, the GTA is applied 9 cycles of 50Hz AC(180 ms) continuously.

Impulse Surge Life

The life is defined as the minimum number of surges of a certain current waveform the GTA can survive without deterioration of its operating specifications.

Insulation Resistance

This is defined as the resistance value across the terminal of GTA at 100V_{DC} for devices over 230V_{DC} (140V_{DC} for GTA type) breakdown voltage and 50V_{DC} for devices less than 230V_{DC}(140V_{DC} for GTA type) ratings.

DC Breakdown Voltage

The voltage is the minimum slowly rising DC voltage that will cause sparkover when applied across the terminal of the GTA. The GTA shall be placed in darkness for at least 15 min and tested in this condition using a ramp voltage waveform with 100V/s to 500V/s.

The GTA shall be tested with a positive and a negative waveform. The sparkover current for DC sparkover voltage test shall be within 10 amps.

Impulse Breakdown Voltage

The GTA to be exposed to the test shall be kept in total darkness before (for at least 15 min) and during the test. Then, with a ramp voltage with 5kV/ μ s applied to the GTA, the breakdown voltage level is recorded. In case of testing with opposite polarity, using the same GTA, a minimum of 15 min shall elapse.

Maximum Single Impulse Discharge Current

This test is to determine the ability of the GTA to conduct a maximum single impulse Discharge current. The current impulse waveform is 8/20 μ s. The maximum single impulse discharge current is the crest current of the impulse.

Capacitance

The capacitance of the GTA is defined as capacitance across terminals of the GTA at 1 kHz.

Operating Temperature Range

-20°C~65°C

DC Holdover Voltage

This values is defined as the maximum DC voltage across the terminals of the GTA which is expected to clear and restore its high impedance state within 150 ms or less after the passage of a surge.

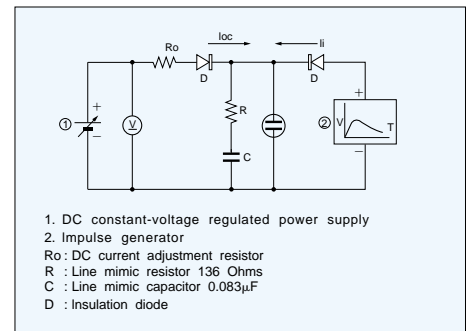

Impulse Waveform

Impulse breakdown voltage is the voltage at which the GTA fires when the voltage increases at rates of more than 100V/ μ s. This value may not vary even after the GTA has been stored in the dark for long period. The value of the impulse breakdown voltage increases with increasing steepness of the surge voltage as the figure below.

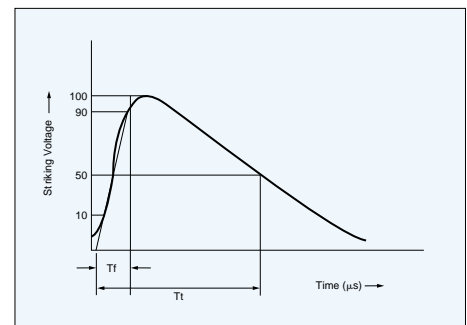

GTA3P type

Dimensions

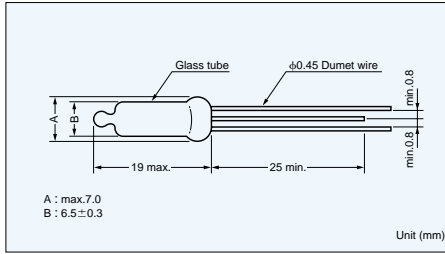

V-t Characteristics

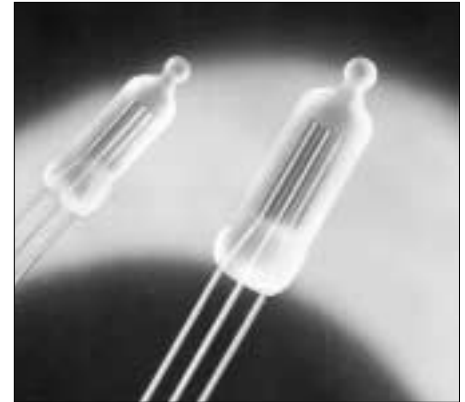
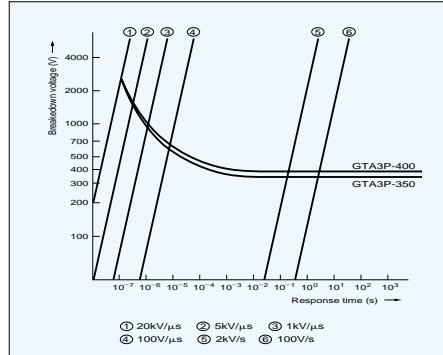

Specifications

| Part No. | DC Breakdown Voltage (100V/s) | Impulse Breakdown Voltage (5kV/μs) | Maximum Single Impulse Discharge Current (8/20μs) | Impulse Life (8/20μs) | Insulation Resistance (DC100V) | Capacitance (1kHz) |
|-----------|-------------------------------|------------------------------------|---|-----------------------|--------------------------------|--------------------|
| GTA3P-350 | 350V ± 15% | 1600V max. | 1500A × 1 time | 350A × 1000 times | 10 ⁴ MΩ min | 1pF max. |
| GTA3P-400 | 400V ± 15% | 1600V max. | | | | |

CM2P, CM3P type

A ceramic tube is sealed at both side by electrodes, and inside of it is filled up by inert gas. The ceramic type gas tube arrester has superior characteristics

such as mechanical strength, surge absorption energy and stability. There are two electrodes type and three electrodes type.

Dimensions

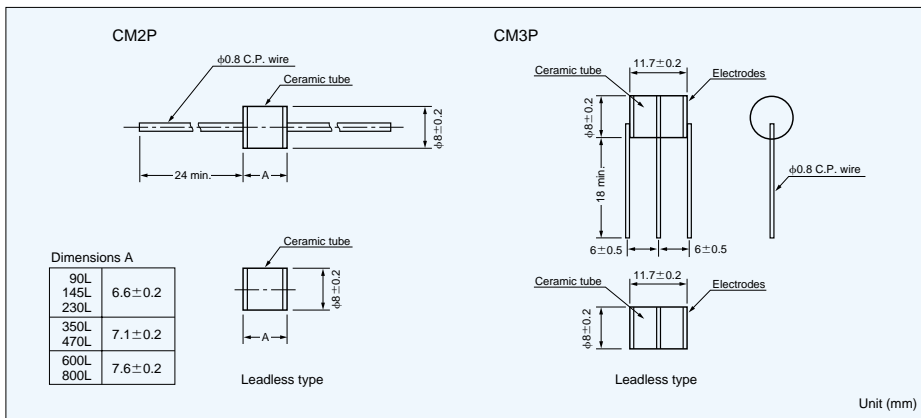

Specifications

| Part No. | DC Breakdown Voltage (100V/s) | Impulse Breakdown Voltage (5kV/μs) | Maximum Single Impulse Discharge Current (8/20μs) | Impulse Life (10/1000μs) | Insulation Resistance (DC100V or 50V) | Capacitance (1kHz) |
|-----------|-------------------------------|------------------------------------|---|--------------------------|---------------------------------------|--------------------|
| CM2P-90L | 90V ± 20% | 1000V max. | 10000A × 2 times | 500A × 600 times | 10 ⁴ MΩ min. | 2pF max. |
| CM2P-145L | 145V ± 20% | 1000V max. | 10000A × 2 times | 500A × 600 times | 10 ⁴ MΩ min. | 2pF max. |
| CM2P-230L | 230V ± 15% | 1000V max. | 10000A × 2 times | 500A × 600 times | 10 ⁴ MΩ min. | 2pF max. |
| CM2P-350L | 350V ± 15% | 1500V max. | 10000A × 2 times | 500A × 600 times | 10 ⁴ MΩ min. | 2pF max. |
| CM2P-470L | 470V ± 15% | 1500V max. | 10000A × 2 times | 500A × 600 times | 10 ⁴ MΩ min. | 2pF max. |
| CM2P-600L | 600V ± 15% | 1800V max. | 10000A × 2 times | 500A × 600 times | 10 ⁴ MΩ min. | 2pF max. |
| CM2P-800L | 800V ± 15% | 2000V max. | 10000A × 2 times | 500A × 600 times | 10 ⁴ MΩ min. | 2pF max. |
| CM3P-230L | 230V ± 20% | 1000V max. | 10000A × 2 times | 500A × 600 times | 10 ⁴ MΩ min. | 2pF max. |
| CM3P-250L | 250V ± 20% | 1000V max. | 10000A × 2 times | 500A × 600 times | 10 ⁴ MΩ min. | 2pF max. |
| CM3P-350L | 350V ± 20% | 1200V max. | 10000A × 2 times | 500A × 600 times | 10 ⁴ MΩ min. | 2pF max. |
| CM3P-400L | 400V ± 20% | 1200V max. | 10000A × 2 times | 500A × 600 times | 10 ⁴ MΩ min. | 2pF max. |

● Suffix : L shows lead type and no-suffix shows leadless type

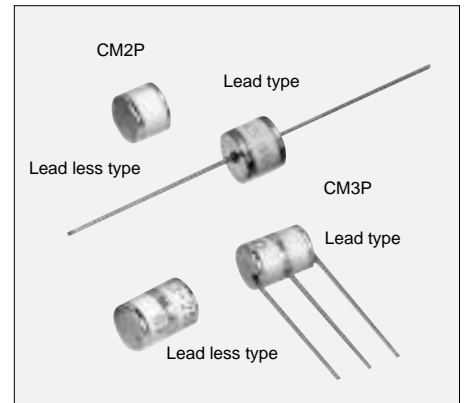

V-t Characteristics

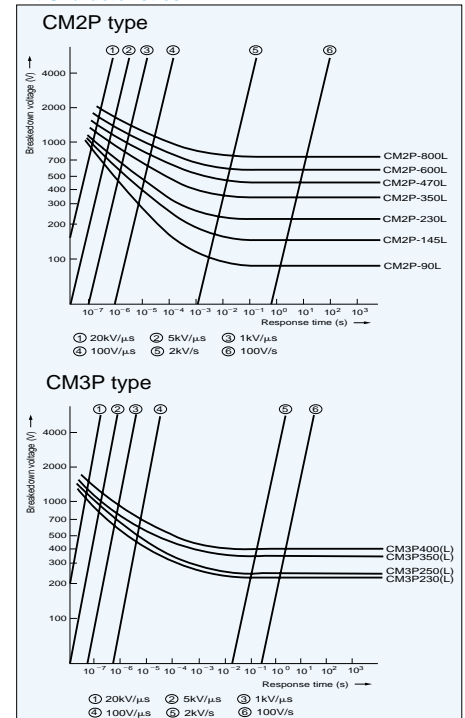

M2P type

A glass tube is sealed at both side by electrodes, and inside of it is filled up by inert gas.

Dimensions

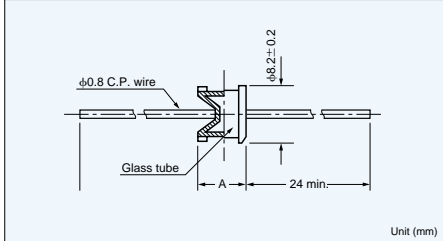

| Dimension A | | | | | | |
|-------------|----------|----------|----------|----------|----------|----------|
| M2P-90L | M2P-145L | M2P-230L | M2P-350L | M2P-470L | M2P-600L | M2P-800L |
| 6.1±0.2 | 6.1±0.2 | 6.6±0.3 | 6.6±0.3 | 6.6±0.3 | 6.6±0.3 | 7.6±0.3 |

Unit (mm)

V-t Characteristics

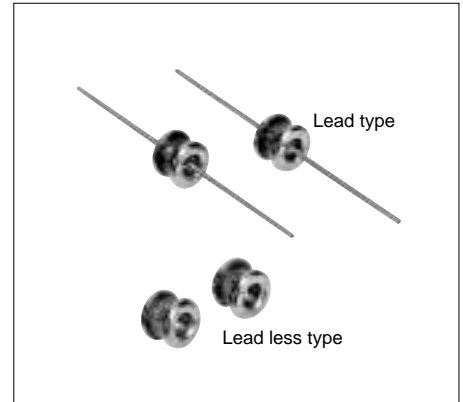
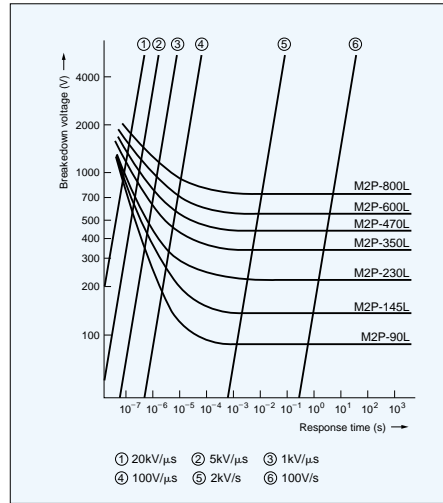

Specifications

| Part No. | DC Breakdown Voltage (100V/s) | Impulse Breakdown Voltage (5kV/μs) | Maximum Single Impulse Discharge Current (8/20μs) | Impulse Life (10/1000μs) | Insulation Resistance (DC 100V or 50V) | Capacitance (1kHz) |
|----------|-------------------------------|------------------------------------|---|--------------------------|--|--------------------|
| M2P-90L | 90V ±20% | 1000V max. | 3000A ×2 times | 500A ×100 times | 10 ⁴ MΩ min. | 2pF max. |
| M2P-145L | 145V ±20% | 1000V max. | 3000A ×2 times | 500A ×100 times | 10 ⁴ MΩ min. | 2pF max. |
| M2P-230L | 230V ±15% | 1000V max. | 3000A ×2 times | 500A ×100 times | 10 ⁴ MΩ min. | 2pF max. |
| M2P-350L | 350V ±15% | 1500V max. | 3000A ×2 times | 500A ×100 times | 10 ⁴ MΩ min. | 2pF max. |
| M2P-470L | 470V ±15% | 1500V max. | 3000A ×2 times | 500A ×100 times | 10 ⁴ MΩ min. | 2pF max. |
| M2P-600L | 600V ±15% | 2500V max. | 3000A ×2 times | 500A ×100 times | 10 ⁴ MΩ min. | 2pF max. |
| M2P-800L | 800V ±15% | 2500V max. | 3000A ×2 times | 500A ×100 times | 10 ⁴ MΩ min. | 2pF max. |

● Suffix : shows lead type and no-suffix shows leadless type

GTA type

Electrodes are set in a sealed glass, and inert gas is filled inside.

Dimensions

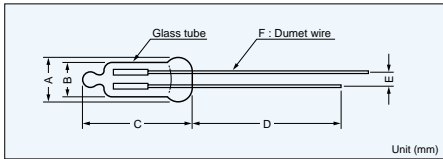

| | GTA-80D~GTA-500D | GTA-750D,800D |
|---|---------------------|--------------------|
| A | 6.4max. | 7.0max. |
| B | $\phi 5.85 \pm 0.3$ | $\phi 6.5 \pm 0.3$ |
| C | 19max | 19max |
| D | 25min. | 25min. |
| E | 3min. | 3min. |
| F | $\phi 0.45$ | $\phi 0.45$ |

Unit (mm)

V-t Characteristics

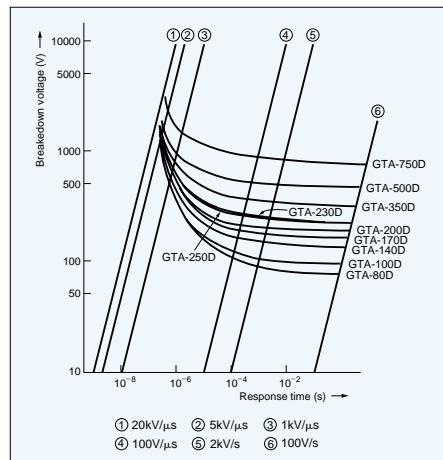

Specifications

| Part No. | DC Breakdown Voltage (100V/s) | Impulse Breakdown Voltage (5kV/μs) | Maximum Single Impulse Discharge Current (8/20μs) | Impulse Life (8/20μs) | Insulation Resistance (DC 100V or 50V) | Capacitance (1kHz) |
|----------|-------------------------------|------------------------------------|---|-----------------------|--|--------------------|
| GTA-80D | 80V ±15% | 1200V max. | 1500A ×1 time | 500A ×1000 times | 10 ⁴ MΩ min. | 2pF max. |
| GTA-100D | 100V ±15% | 1300V max. | 1500A ×1 time | 500A ×1000 times | 10 ⁴ MΩ min. | 2pF max. |
| GTA-140D | 140V ±15% | 1300V max. | 1500A ×1 time | 500A ×1000 times | 10 ⁴ MΩ min. | 2pF max. |
| GTA-170D | 170V ±15% | 1500V max. | 1500A ×1 time | 500A ×1000 times | 10 ⁴ MΩ min. | 2pF max. |
| GTA-200D | 200V ±15% | 1700V max. | 1500A ×1 time | 500A ×1000 times | 10 ⁴ MΩ min. | 2pF max. |
| GTA-230D | 230V ±15% | 1700V max. | 1500A ×1 time | 500A ×1000 times | 10 ⁴ MΩ min. | 2pF max. |
| GTA-250D | 250V ±15% | 1700V max. | 1500A ×1 time | 500A ×1000 times | 10 ⁴ MΩ min. | 2pF max. |
| GTA-350D | 350V ±15% | 2000V max. | 1500A ×1 time | 500A ×1000 times | 10 ⁴ MΩ min. | 2pF max. |
| GTA-500D | 500V ±15% | 2100V max. | 1500A ×1 time | 500A ×1000 times | 10 ⁴ MΩ min. | 2pF max. |
| GTA-750D | 750V ±15% | 4500V max. | 1500A ×1 time | 500A ×1000 times | 10 ⁴ MΩ min. | 2pF max. |
| GTA-800D | 800V ±15% | 5000V max. | 1500A ×1 time | 500A ×1000 times | 10 ⁴ MΩ min. | 2pF max. |

SA01 type

The SA01 is a new product which can be utilized for protecting transient voltage in power supply of equipment with earth terminal.

For the equipment in which SA01 is used, the AC withstanding voltage between power lines and earth terminal can be tested without taking off "SA01".

Dimensions

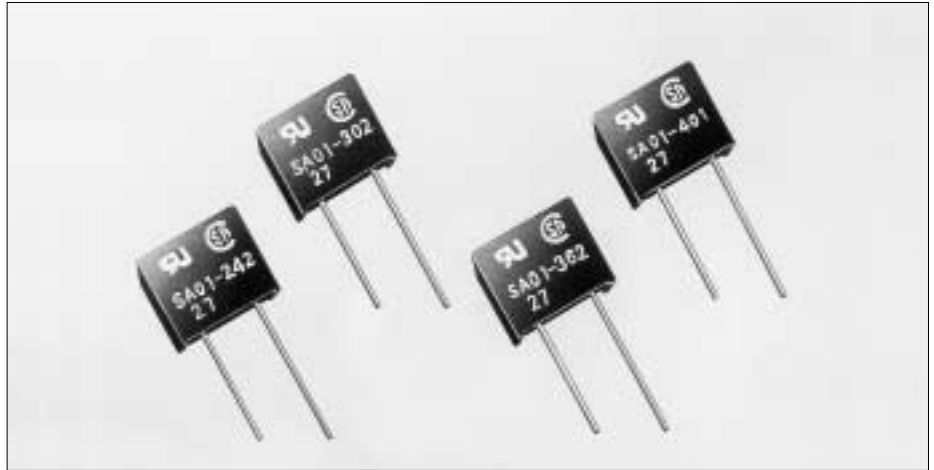
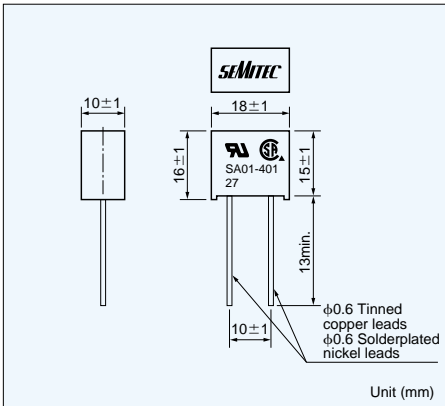

Safety Standards

| Standards Name | UL | CSA | TÜV |
|----------------|---------|------------|-----------|
| Standards No. | UL1449 | C22.2 No.1 | IEC61051 |
| File No. | E128417 | LR-76099 | J500/5463 |
| Mark | | | — |

Specifications

| Part No. | DC Breakdown Voltage (100V/s) | Impulse Breakdown Voltage (5kV/μs) | Maximum Single Impulse Discharge Current(8/20μs) | Impulse Life (8/20μs) | Insulation Resistance (DC100V) | Capacitance (1kHz) | Connection | Dielectric Withstanding Voltage |
|----------|-------------------------------|------------------------------------|--|-----------------------|--------------------------------|--------------------|--------------------|---------------------------------|
| SA01-401 | 400V $\pm 20\%$ | 1000V max. | 1250A×2 times | 100A×300 times | 10 ² MΩ min | 2pF max. | AC125V (Line-Line) | — |
| SA01-501 | 500V $\pm 20\%$ | 1400V max. | 1250A×2 times | 100A×300 times | 10 ² MΩ min | 2pF max. | AC250V (Line-Line) | — |
| SA01-242 | 2400V $\pm 20\%$ | 4000V max. | 1250A×2 times | 100A×300 times | 10 ² MΩ min | 2pF max. | AC125V (Line-GND) | AC1200V 3s |
| SA01-302 | 3000V $\pm 20\%$ | 4500V max. | 1250A×2 times | 100A×300 times | 10 ² MΩ min | 2pF max. | AC250V (Line-GND) | AC1500V 1min |
| SA01-362 | 3600V $\pm 20\%$ | 5000V max. | 1250A×2 times | 100A×300 times | 10 ² MΩ min | 2pF max. | AC250V (Line-GND) | AC1800V 3s |

Application Circuit

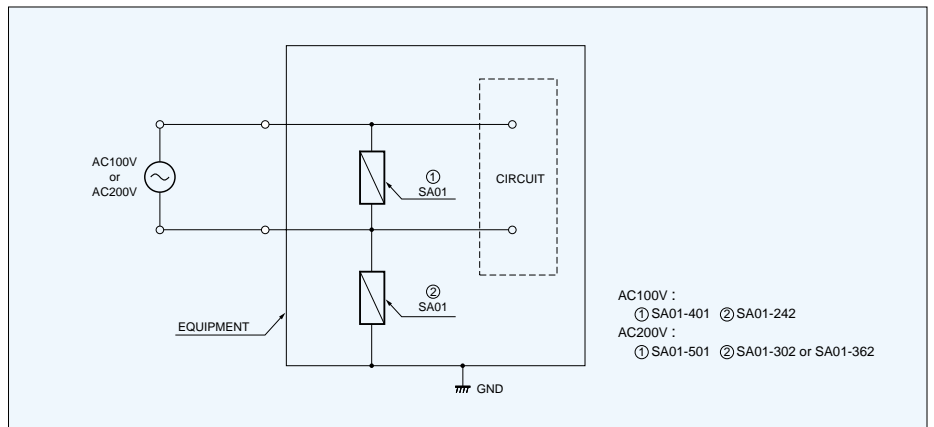

The manufacturer hereby warrants, that it will replace this product or any part thereof which shall prove to be defective in workmanship or material, subject to the following limitations:

- (1) This is only for the benefit of the original purchaser and to no other person, company or individual.
- (2) This warranty does not apply to defects caused by improper installation.
- (3) This warranty is limited to the replacement of the defective product, or part thereof, and does not include any labor costs for installation or removal of the product.
- (4) The manufacturer shall not be liable for indirect, consequential or special damages and is limited solely to replacement of the product.

If the product or any part thereof shall prove to be defective in workmanship or material, the original purchaser shall ship the product to the manufacturer in the original packing carton, together with a copy of the original sales receipt for the product, and, if in the opinion of the manufacturer, the product proves to be defective in workmanship or material, the sole obligation of the manufacturer shall be the replacement of the defective product or part thereof. Shipping charges to the manufacturer is the obligation of the original purchaser.

This limited warranty is in lieu of and replaces all of the warranties previously given by the manufacturer, both express and implied, including any warranties of merchantability or fitness for a particular purpose. There are no warranties which extend beyond the face hereof.

No lawsuit may be commenced against the manufacturer unless the original consumer purchaser has complied with all of the terms and conditions of this warranty and the manufacturer has refused to comply therewith.

ISO9002 ISO14001 Certified

SEMITEC®

Ishizuka Electronics Corporation

HEAD OFFICE:7-7, Kinshi 1-Chome, Sumida-ku, Tokyo, 130-8512 Japan

TEL:81-3-3621-2704 FAX:81-3-3623-6815

E-mail : overseas@mail.semitec.co.jp

SEMITEC GROUP

| | |
|---------------------------------|--|
| USA:SEMITEC USA CORP. | TEL:1-631-587-4086 FAX:1-631-321-9604 E-mail : sales@semitec-usa.com |
| HONG KONG:SEMITEC(H.K.)CO.,LTD. | TEL:852-2369-6773 FAX:852-2739-2396 E-mail : semihk@netvigator.com |
| TAIWAN:SEMITEC TAIWAN CORP. | TEL:886-2-2509-9855 FAX:886-2-2509-9599 E-mail : semitec@ms24.hinet.net |
| UK:ATC SEMITEC LTD. | TEL:44-1565-750538 FAX:44-1565-652396 E-mail : sales@atcsemitec.co.uk |
| KOREA:SEMITEC KOREA CO.,LTD. | TEL:82-2-3281-1155 FAX:82-2-3281-3338 E-mail : semitec@kornet.net |
| CHINA:SEMITEC SHANGHAI OFFICE | TEL:86-21-53086000 FAX:86-21-33040188 E-mail : xsgsxh@public.tz.js.cn |

Visit us on the Web at <http://www.semitec.co.jp/>