

Optocoupler, Phototransistor Output, with Base Connection

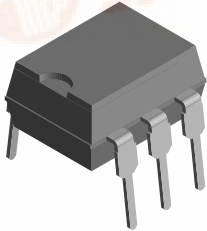

1179004

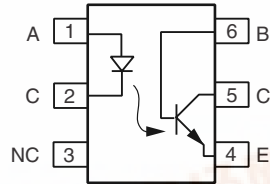

DESCRIPTION

The SFH600 is an optocoupler with a GaAs LED emitter which is optically coupled with a silicon planar phototransistor detector. The component is packaged in a plastic plug-in case, 20 AB DIN 41866.

The coupler transmits signals between two electrically isolated circuits. The potential difference between the circuits to be coupled should not exceed the maximum permissible insulating voltage.

FEATURES

- Isolation test voltage (1.0 s), 5300 V_{RMS}
- $V_{CEsat} = 0.25 (\leq 0.4) \text{ V}$, $I_F = 10 \text{ mA}$, $I_C = 2.5 \text{ mA}$
- Built to conform to VDE requirements
- High quality premium device
- Long term stability
- Storage temperature, $-55 \text{ }^\circ\text{C}$ to $+150 \text{ }^\circ\text{C}$
- Lead (Pb)-free component
- Component in accordance to RoHS 2002/95/EC and WEEE 2002/96/EC



RoHS
COMPLIANT

AGENCY APPROVALS

- UL1577, file no. E52744 system code H or J, double protection
- DIN EN 60747-5-5 (VDE 0884) available with option 1
- CSA 93751
- BSI IEC 60950; IEC 60065

ORDER INFORMATION

PART	REMARKS
SFH600-0	CTR 40 % to 80 %, DIP-6
SFH600-1	CTR 63 % to 125 %, DIP-6
SFH600-2	CTR 100 % to 200 %, DIP-6
SFH600-3	CTR 160 % to 320 %, DIP-6
SFH600-0X007	CTR 40 % to 80 %, SMD-6 (option 7)
SFH600-1X007	CTR 63 % to 125 %, SMD-6 (option 7)
SFH600-1X009	CTR 63 % to 125 %, SMD-6 (option 9)
SFH600-2X006	CTR 100 % to 200 %, DIP-6 400 mil (option 6)
SFH600-2X007	CTR 100 % to 200 %, SMD-6 (option 7)
SFH600-3X006	CTR 160 % to 320 %, DIP-6 400 mil (option 6)
SFH600-3X007	CTR 160 % to 320 %, SMD-6 (option 7)

Note

For additional information on the available options refer to option information.

ABSOLUTE MAXIMUM RATINGS (1)

PARAMETER	TEST CONDITION	SYMBOL	VALUE	UNIT
INPUT				
Reverse voltage		V_R	6.0	V
DC forward current		I_F	60	mA
Surge forward current	$t_p \leq 10 \mu\text{s}$	I_{FSM}	2.5	A
Total power dissipation		P_{diss}	100	mW
OUTPUT				
Collector emitter voltage		V_{CE}	70	V
Emitter base voltage		V_{EB}	7.0	V
Collector current		I_C	50	mA
	$t = 1.0 \text{ ms}$	I_C	100	mA
Power dissipation		P_{diss}	150	mW

ABSOLUTE MAXIMUM RATINGS (1)				
PARAMETER	TEST CONDITION	SYMBOL	VALUE	UNIT
COUPLER				
Isolation test voltage between emitter and detector	$t = 1.0 \text{ s}$	V_{ISO}	5300	V_{RMS}
Creepage distance			≥ 7	mm
Clearance distance			≥ 7	mm
Isolation thickness between emitter and detector			≥ 0.4	mm
Comparative tracking index per DIN IEC 112/VDE 0303, part 1			175	
Isolation resistance	$V_{IO} = 500 \text{ V}, T_{amb} = 25 \text{ }^\circ\text{C}$	R_{IO}	$\geq 10^{12}$	Ω
	$V_{IO} = 500 \text{ V}, T_{amb} = 100 \text{ }^\circ\text{C}$	R_{IO}	$\geq 10^{11}$	Ω
Storage temperature range		T_{stg}	- 55 to + 150	$^\circ\text{C}$
Ambient temperature range		T_{amb}	- 55 to + 100	$^\circ\text{C}$
Junction temperature	max. 10 s, dip soldering	T_j	100	$^\circ\text{C}$
Soldering temperature (2)	max. 10 s, dip soldering: distance to seating plane $\geq 1.5 \text{ mm}$	T_{sld}	260	$^\circ\text{C}$

Notes

(1) $T_{amb} = 25 \text{ }^\circ\text{C}$, unless otherwise specified.

Stresses in excess of the absolute maximum ratings can cause permanent damage to the device. Functional operation of the device is not implied at these or any other conditions in excess of those given in the operational sections of this document. Exposure to absolute maximum ratings for extended periods of the time can adversely affect reliability.

(2) Refer to reflow profile for soldering conditions for surface mounted devices (SMD). Refer to wave profile for soldering conditions for through hole devices (DIP).

ELECTRICAL CHARACTERISTICS							
PARAMETER	TEST CONDITION	PART	SYMBOL	MIN.	TYP.	MAX.	UNIT
INPUT							
Forward voltage	$I_F = 60 \text{ mA}$		V_F		1.25	1.65	V
Breakdown voltage	$I_R = 10 \text{ } \mu\text{A}$		V_{BR}	6			V
Reverse current	$V_R = 6 \text{ V}$		I_R		0.01	10	μA
Capacitance	$V_F = 0 \text{ V}, f = 1 \text{ MHz}$		C_O		25		pF
Thermal resistance			R_{thja}		750		K/W
OUTPUT							
Collector emitter capacitance	$f = 1 \text{ MHz}, V_{CE} = 5 \text{ V}$		C_{CE}		5.2		pF
Collector base capacitance	$f = 1 \text{ MHz}, V_{CB} = 5 \text{ V}$		C_{CB}		6.5		pF
Emitter base capacitance	$f = 1 \text{ MHz}, V_{EB} = 5 \text{ V}$		C_{EB}		9.5		pF
Thermal resistance			R_{thja}		500		K/W
Collector emitter leakage current	$V_{CE} = 10 \text{ V}$	SFH600-0	I_{CEO}		2	35	nA
		SFH600-1	I_{CEO}		2	35	nA
		SFH600-2	I_{CEO}		2	35	nA
		SFH600-3	I_{CEO}		5	70	nA
COUPLER							
Saturation voltage collector emitter voltage	$I_F = 10 \text{ mA}, I_C = 2.5 \text{ mA}$		V_{CEsat}		0.25	0.4	V
Capacitance (input to output)			C_{IO}			0.6	pF

Note

$T_{amb} = 25 \text{ }^\circ\text{C}$, unless otherwise specified.

Minimum and maximum values are testing requirements. Typical values are characteristics of the device and are the result of engineering evaluation. Typical values are for information only and are not part of the testing requirements.

CURRENT TRANSFER RATIO							
PARAMETER	TEST CONDITION	PART	SYMBOL	MIN.	TYP.	MAX.	UNIT
I_C/I_F at $V_{CE} = 5.0\text{ V}$	$I_F = 10\text{ mA}$	SFH600-0	CTR	40		80	%
		SFH600-1	CTR	63		125	%
		SFH600-2	CTR	100		200	%
		SFH600-3	CTR	160		320	%
	$I_F = 1\text{ mA}$	SFH600-0	CTR	13	30		%
		SFH600-1	CTR	22	45		%
		SFH600-2	CTR	34	70		%
		SFH600-3	CTR	56	90		%

SWITCHING CHARACTERISTICS							
PARAMETER	TEST CONDITION	PART	SYMBOL	MIN.	TYP.	MAX.	UNIT
NON-SATURATED							
Current	$V_{CC} = 5\text{ V}, R_L = 75\ \Omega$		I_F		10		mA
Rise time	$V_{CC} = 5\text{ V}, R_L = 75\ \Omega$		t_r		2		μs
Fall time	$V_{CC} = 5\text{ V}, R_L = 75\ \Omega$		t_f		2.5		μs
Turn-on time	$V_{CC} = 5\text{ V}, R_L = 75\ \Omega$		t_{on}		3.2		μs
Turn-off time	$V_{CC} = 5\text{ V}, R_L = 75\ \Omega$		t_{off}		3		μs
Cut-off frequency	$V_{CC} = 5\text{ V}, R_L = 75\ \Omega$		F_{CO}		250		kHz
SATURATED							
Current		SFH600-0	I_F		20		mA
		SFH600-1	I_F		10		mA
		SFH600-2	I_F		10		mA
		SFH600-3	I_F		5		mA
Rise time		SFH600-0	t_r		2.5		μs
		SFH600-1	t_r		3		μs
		SFH600-2	t_r		3		μs
		SFH600-3	t_r		4		μs
Fall time		SFH600-0	t_f		11		μs
		SFH600-1	t_f		12		μs
		SFH600-2	t_f		12		μs
		SFH600-3	t_f		14		μs
Turn-on time		SFH600-0	t_{on}		3.7		μs
		SFH600-1	t_{on}		4.5		μs
		SFH600-2	t_{on}		4.5		μs
		SFH600-3	t_{on}		5.8		μs
Turn-off time		SFH600-0	t_{off}		19		μs
		SFH600-1	t_{off}		21		μs
		SFH600-2	t_{off}		21		μs
		SFH600-3	t_{off}		24		μs

TYPICAL CHARACTERISTICS

$T_{amb} = 25\text{ }^{\circ}\text{C}$, unless otherwise specified

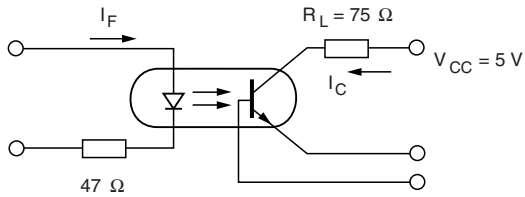

isfh600_01

Fig. 1 - Linear Operation (without Saturation)

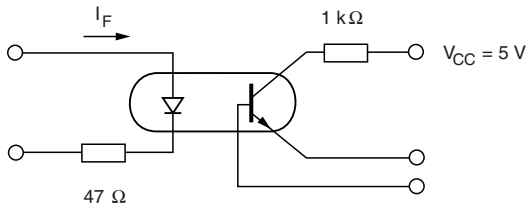

isfh600_02

Fig. 2 - Switching Operation (with Saturation)

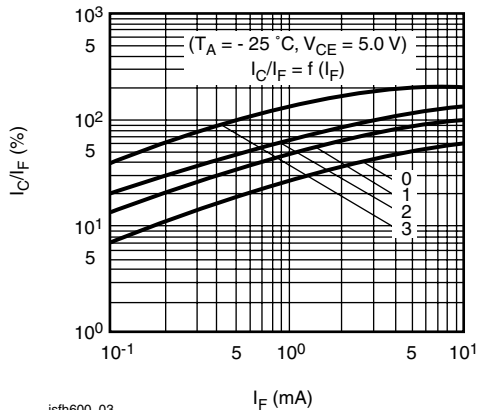

isfh600_03

Fig. 3 - Current Transfer Ratio vs. Diode Current

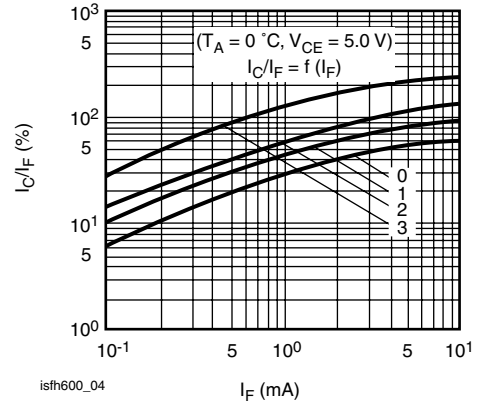

isfh600_04

Fig. 4 - Current Transfer Ratio vs. Diode Current

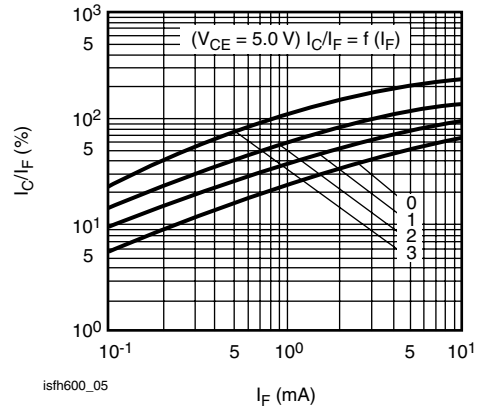

isfh600_05

Fig. 5 - Current Transfer Ratio vs. Diode Current

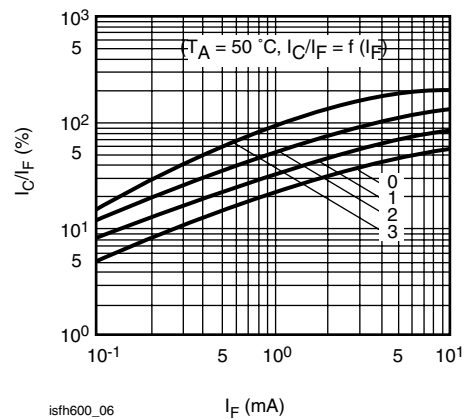

isfh600_06

Fig. 6 - Current Transfer Ratio vs. Diode Current

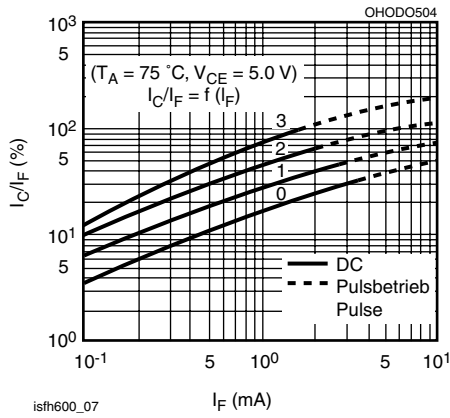

Fig. 7 - Current Transfer Ratio vs. Diode Current

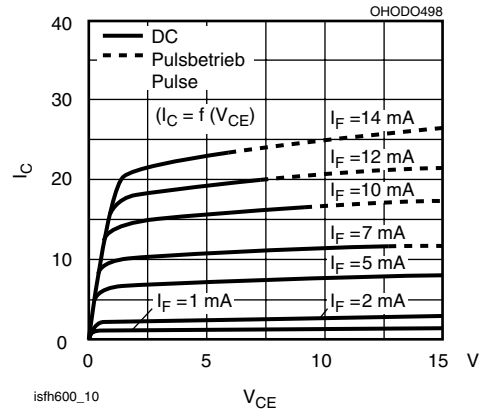

Fig. 10 - Output Characteristics SFH600-2, -3

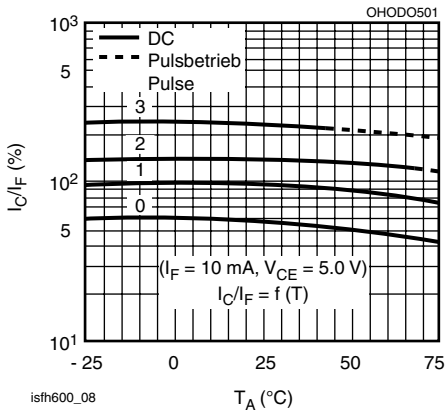

Fig. 8 - Current Transfer Ratio (CTR) vs. Temperature

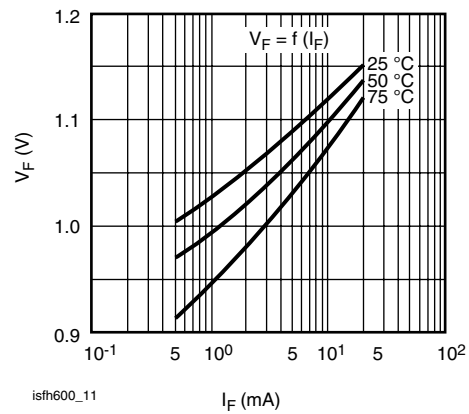

Fig. 11 - Forward Voltage

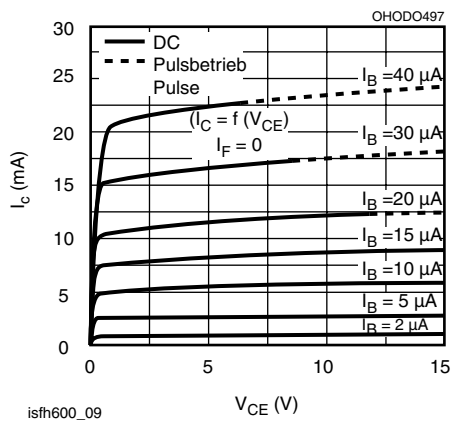

Fig. 9 - Transistor Characteristics SFH600-2, -3

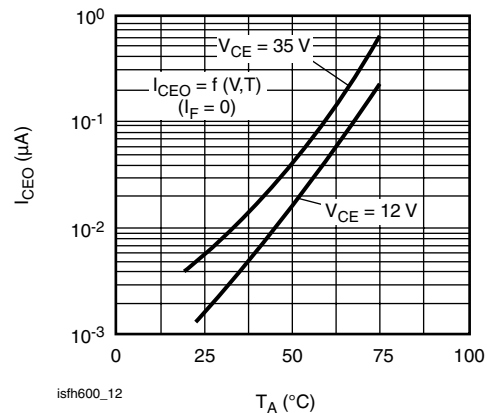

Fig. 12 - Collector Emitter Off-state Current

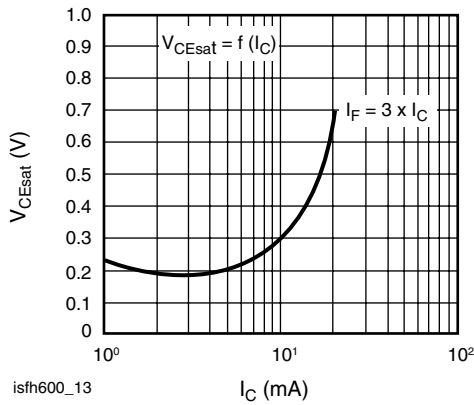

Fig. 13 - Saturation Voltage vs. Collector Current and Modulation Depth SFH600-0

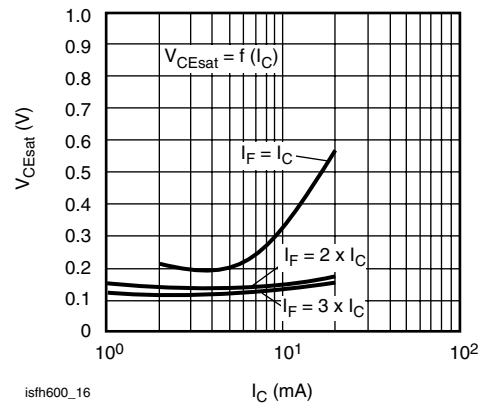

Fig. 16 - Saturation Voltage vs. Collector Current and Modulation Depth SFH600-3

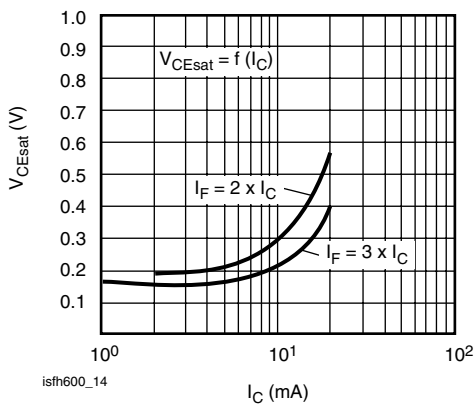

Fig. 14 - Saturation Voltage vs. Collector Current and Modulation Depth SFH600-1

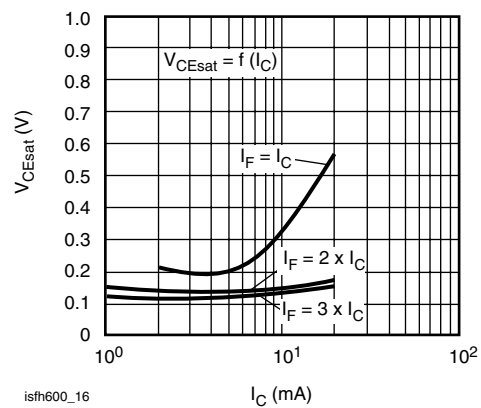

Fig. 17 - Permissible Pulse Load

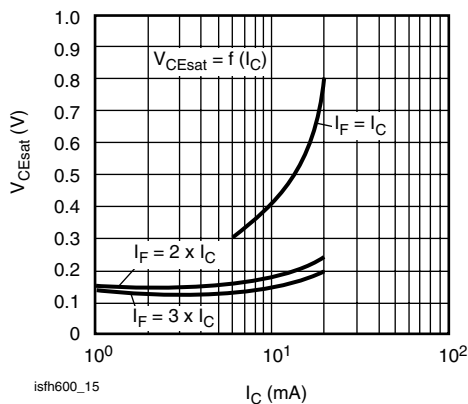

Fig. 15 - Saturation Voltage vs. Collector Current and Modulation Depth SFH600-2

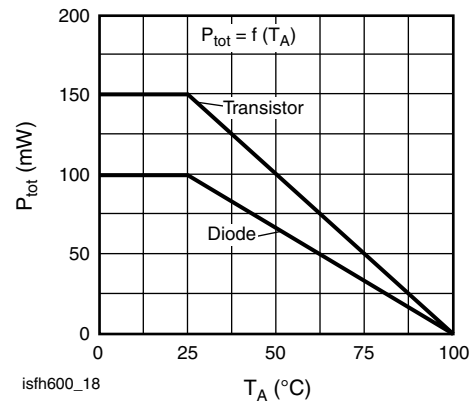

Fig. 18 - Permissible Power Dissipation for Transistor and Diode

Vishay Semiconductors Optocoupler, Phototransistor Output, with Base Connection

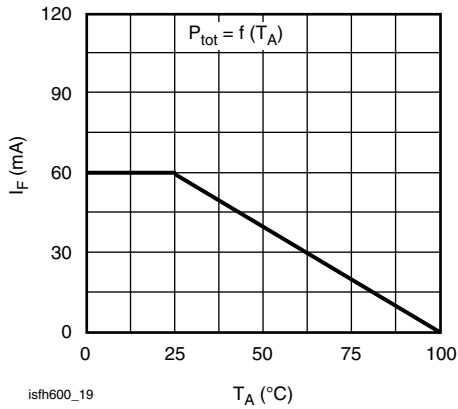

Fig. 19 - Permissible Forward Current Diode

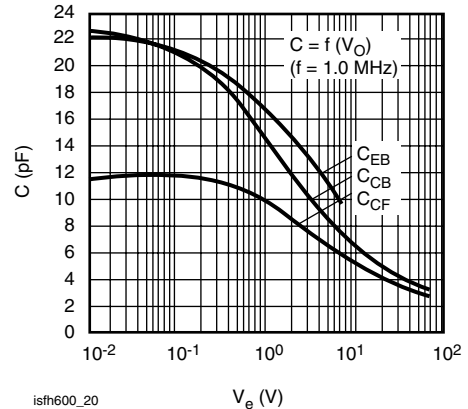
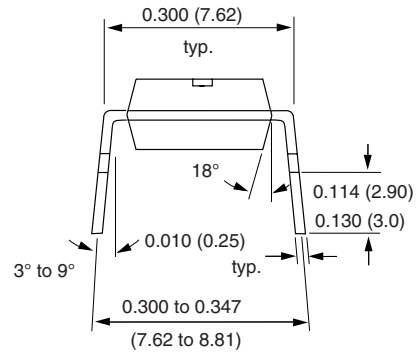
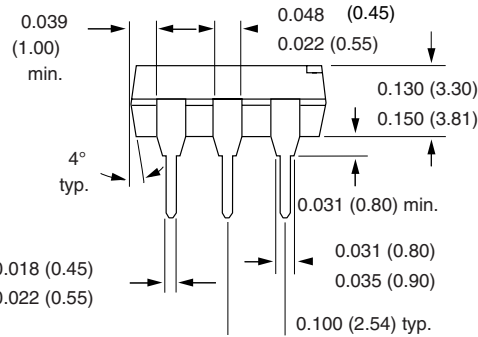
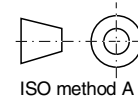
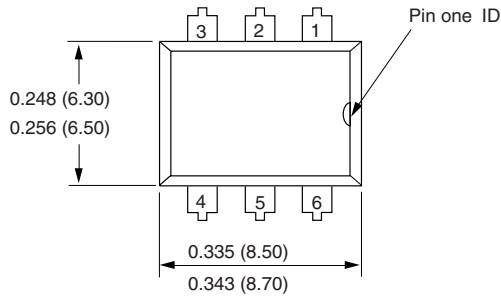
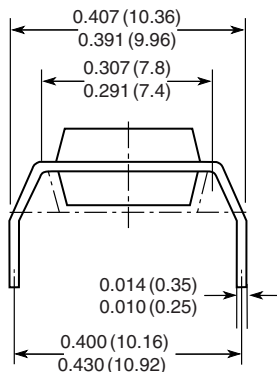

Fig. 20 - Transistor Capacitance

PACKAGE DIMENSIONS in inches (millimeters)



Option 6



Option 7

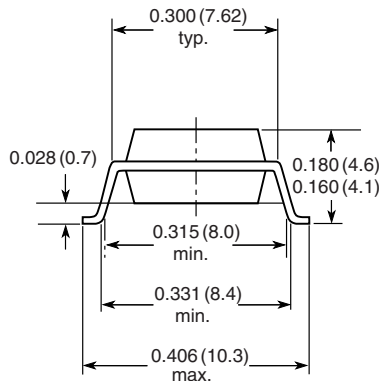

Option 9

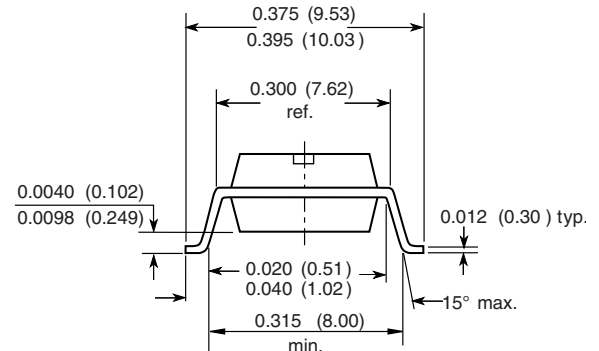

18450



OZONE DEPLETING SUBSTANCES POLICY STATEMENT

It is the policy of Vishay Semiconductor GmbH to

1. Meet all present and future national and international statutory requirements.
2. Regularly and continuously improve the performance of our products, processes, distribution and operating systems with respect to their impact on the health and safety of our employees and the public, as well as their impact on the environment.

It is particular concern to control or eliminate releases of those substances into the atmosphere which are known as ozone depleting substances (ODSs).

The Montreal Protocol (1987) and its London Amendments (1990) intend to severely restrict the use of ODSs and forbid their use within the next ten years. Various national and international initiatives are pressing for an earlier ban on these substances.

Vishay Semiconductor GmbH has been able to use its policy of continuous improvements to eliminate the use of ODSs listed in the following documents.

1. Annex A, B and list of transitional substances of the Montreal Protocol and the London Amendments respectively.
2. Class I and II ozone depleting substances in the Clean Air Act Amendments of 1990 by the Environmental Protection Agency (EPA) in the USA.
3. Council Decision 88/540/EEC and 91/690/EEC Annex A, B and C (transitional substances) respectively.

Vishay Semiconductor GmbH can certify that our semiconductors are not manufactured with ozone depleting substances and do not contain such substances.

We reserve the right to make changes to improve technical design
and may do so without further notice.

Parameters can vary in different applications. All operating parameters must be validated for each customer application by the customer. Should the buyer use Vishay Semiconductors products for any unintended or unauthorized application, the buyer shall indemnify Vishay Semiconductors against all claims, costs, damages, and expenses, arising out of, directly or indirectly, any claim of personal damage, injury or death associated with such unintended or unauthorized use.

Vishay Semiconductor GmbH, P.O.B. 3535, D-74025 Heilbronn, Germany

Disclaimer

All product specifications and data are subject to change without notice.

Vishay Intertechnology, Inc., its affiliates, agents, and employees, and all persons acting on its or their behalf (collectively, "Vishay"), disclaim any and all liability for any errors, inaccuracies or incompleteness contained herein or in any other disclosure relating to any product.

Vishay disclaims any and all liability arising out of the use or application of any product described herein or of any information provided herein to the maximum extent permitted by law. The product specifications do not expand or otherwise modify Vishay's terms and conditions of purchase, including but not limited to the warranty expressed therein, which apply to these products.

No license, express or implied, by estoppel or otherwise, to any intellectual property rights is granted by this document or by any conduct of Vishay.

The products shown herein are not designed for use in medical, life-saving, or life-sustaining applications unless otherwise expressly indicated. Customers using or selling Vishay products not expressly indicated for use in such applications do so entirely at their own risk and agree to fully indemnify Vishay for any damages arising or resulting from such use or sale. Please contact authorized Vishay personnel to obtain written terms and conditions regarding products designed for such applications.

Product names and markings noted herein may be trademarks of their respective owners.