

## 1. General description

The NE58633 is a stereo, noise reduction, class-D, Bridge-Tied Load (BTL) headphone driver amplifier. Each channel comprises a class-D BTL headphone driver amplifier, an electret microphone low noise preamplifier, feedback noise reduction circuit and a music amplifier input.

The NE58633 operates with a battery voltage of 0.9 V to 1.7 V. The chip employs an on-chip DC-to-DC boost converter and internal  $V_{ref}$  voltage reference which is filtered and output to ground for noise decoupling. It features mute control and plop and click reduction circuitry. The gain of the microphone amplifier and filter amplifier is set using external resistors. Differential architecture provides increased immunity to noise.

The NE58633 is capable of driving 800 mV<sub>rms</sub> across a 16  $\Omega$  or 32  $\Omega$  load and provides ElectroStatic Discharge (ESD) and short-circuit protection.

It is available in the 32-pin HVQFN32 (5 mm  $\times$  5 mm  $\times$  0.85 mm) package suitable for high density small-scale layouts and is an ideal choice for noise reduction headphones and educational audio aids.

## 2. Features

- Low current consumption of 4.4 mA
- 0.9 V to 1.7 V battery operating voltage range
- 1 % THD+N at  $V_O = 1 V_M$  driving 16  $\Omega$  with a battery voltage of 1.5 V
- 10 % THD+N at 800 mV<sub>rms</sub> output voltage driving 16  $\Omega$  and 32  $\Omega$  loads with a battery voltage of 1.5 V
- Output noise voltage with noise reduction circuit typically 31 mV<sub>rms</sub> for  $G_{V(c)} = 25$  dB
- On-chip mute function
- Plop and click reduction circuitry
- Class-D BTL differential output configuration
- Electret microphone noise reduction polarization amplifier with external gain adjustment using resistors
- Music and filter amplifier with external gain adjustment using resistors
- DC-to-DC converter circuitry (3 V output) with 2.5 mA (typical) load current
- Internal voltage reference pinned out for noise decoupling
- Available in HVQFN32 package

### 3. Ordering information

Table 1. Ordering information

Type number	Package		Version
	Name	Description	
NE58633BS	HVQFN32	plastic thermal enhanced very thin quad flat package; no leads; 32 terminals; body 5 × 5 × 0.85 mm	SOT617-1

### 4. Block diagram

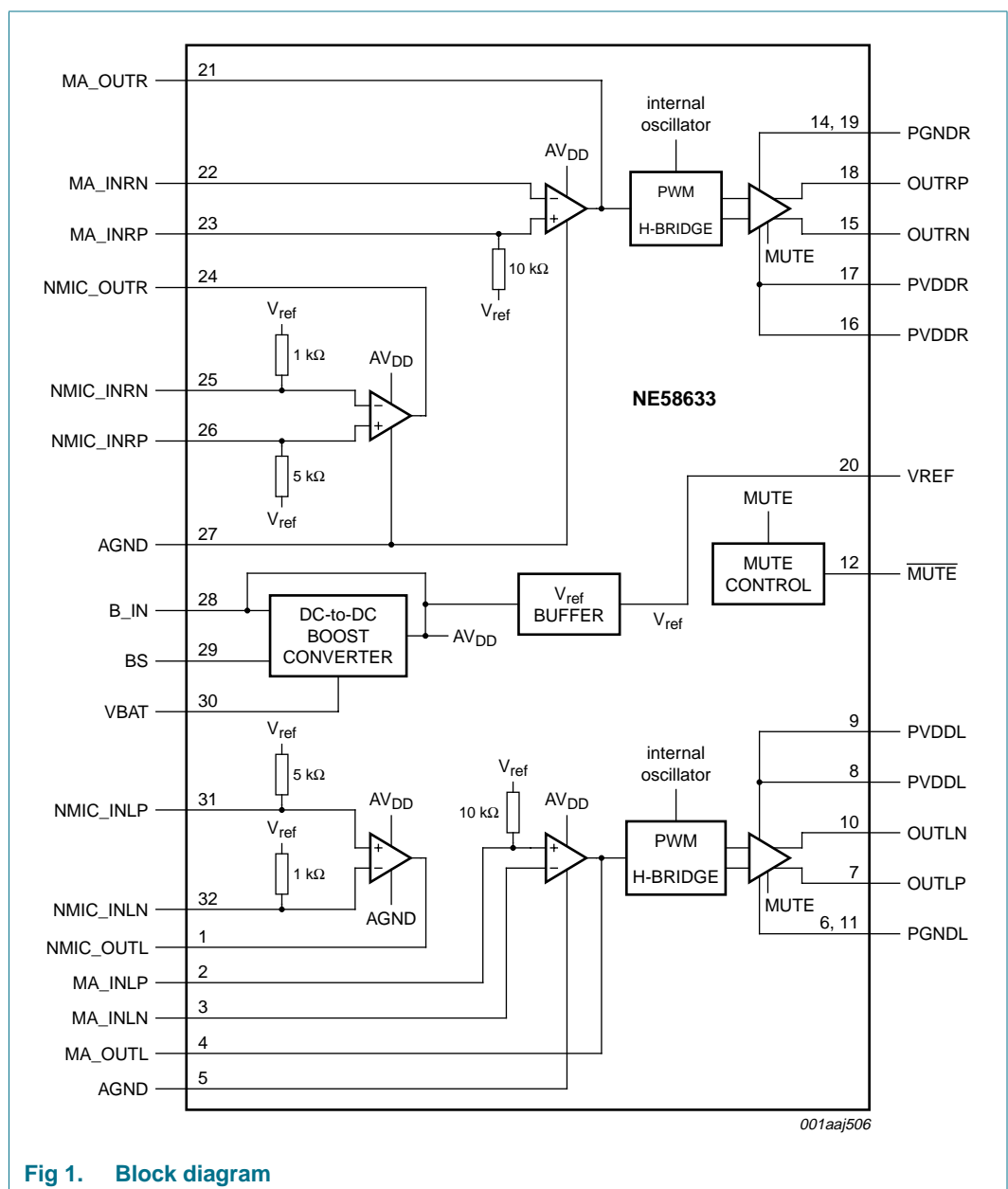

Fig 1. Block diagram

## 5. Pinning information

### 5.1 Pinning

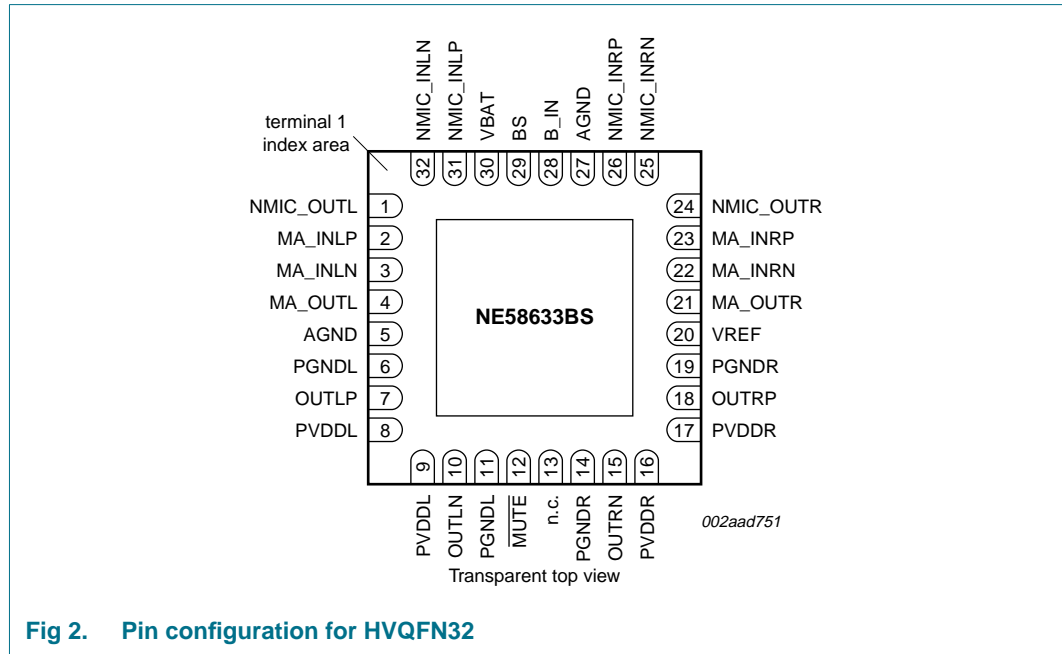

Fig 2. Pin configuration for HVQFN32

### 5.2 Pin description

Table 2. Pin description

Symbol	Pin	Description
NMIC_OUTL	1	noise reduction microphone preamplifier output, left channel
MA_INLP	2	music amplifier positive input, left channel
MA_INLN	3	music amplifier negative input, left channel
MA_OUTL	4	music amplifier output, left channel
AGND	5	analog ground
PGNDL	6	power ground, headphone driver, left channel
OUTLP	7	headphone positive output, left channel
PVDDL	8, 9	battery supply voltage, headphone driver output, left channel
OUTLN	10	headphone negative output, left channel
PGNDL	11	power ground, headphone driver, left channel
MUTE	12	mute, headphone outputs (active LOW)
n.c.	13	not connected internally; connect pin to ground
PGNDR	14	power ground, headphone driver, right channel
OUTRN	15	headphone negative output, right channel
PVDDR	16, 17	battery supply voltage, headphone driver output, right channel
OUTRP	18	headphone positive output, right channel
PGNDR	19	power ground, headphone driver, right channel
VREF	20	internal voltage reference output

Table 2. Pin description ...continued

Symbol	Pin	Description
MA_OUTR	21	music amplifier output, right channel
MA_INRN	22	music amplifier negative input, right channel
MA_INRP	23	music amplifier positive input, right channel
NMIC_OUTR	24	noise reduction microphone preamplifier output, right channel
NMIC_INRN	25	noise reduction microphone preamplifier negative input, right channel
NMIC_INRP	26	noise reduction microphone preamplifier positive input, right channel
AGND	27	ground, analog
B_IN	28	boost converter input
BS	29	boost converter switching transistor collector
VBAT	30	battery supply voltage
NMIC_INLP	31	Noise reduction microphone preamplifier positive input, left channel
NMIC_INLN	32	Noise reduction microphone preamplifier negative input, left channel

## 6. Limiting values

Table 3. Limiting values

In accordance with the Absolute Maximum Rating System (IEC 60134).  
 $T_{amb} = 25\text{ }^{\circ}\text{C}$ , unless otherwise specified.

Symbol	Parameter	Conditions	Min	Max	Unit
$V_{BAT}$	battery supply voltage	pins VBAT, PVDDL, PVDDR			
		in active mode	-0.3	+1.7	V
		in mute mode	-0.3	+1.7	V
$V_I$	input voltage		-0.3	+2.0	V
$T_{amb}$	ambient temperature	operating	0	70	$^{\circ}\text{C}$
$T_j$	junction temperature	operating	0	150	$^{\circ}\text{C}$
$T_{stg}$	storage temperature		0	150	$^{\circ}\text{C}$

## 7. Recommended operating conditions

Table 4. Operating conditions

Symbol	Parameter	Conditions	Min	Max	Unit
$V_{BAT}$	battery supply voltage	AVDD, PVDD	0.9	1.7	V
$V_{i(cm)}$	common-mode input voltage	music and noise reduction amplifier inputs	0.2	$V_{bst} - 1$	V
$V_{IH}$	HIGH-level input voltage	unmuted; $\overline{\text{MUTE}}$	1	$V_{BAT}$	V
$V_{IL}$	LOW-level input voltage	muted; $\overline{\text{MUTE}}$	0	0.8	V
$T_{amb}$	ambient temperature	operating	0	70	$^{\circ}\text{C}$

## 8. Characteristics

**Table 5. Electrical characteristics**

$T_{amb} = 25\text{ }^{\circ}\text{C}$ ; unless otherwise specified.

Symbol	Parameter	Conditions	Min	Typ	Max	Unit
$ V_{O(\text{offset})} $	output offset voltage	measured differentially; inputs AC grounded; $G_{v(\text{cl})} = 25\text{ dB}$ ; $V_{\text{BAT}} = 0.9\text{ V to }1.7\text{ V}$	-	5	25	mV
$ V_{I(\text{offset})} $	input offset voltage	music amplifier and noise reduction microphone amplifier; measured differentially	-	1	-	mV
$Z_i$	input impedance	music amplifier, non-inverting terminal; $V_{\text{BAT}} = 0.9\text{ V to }1.7\text{ V}$	-	10	-	k $\Omega$
		microphone preamplifier; $V_{\text{BAT}} = 0.9\text{ V to }1.7\text{ V}$	-	1	-	k $\Omega$
		inverting terminal noise reduction	-	5	-	k $\Omega$
$I_{\text{LI}}$	input leakage current	music amplifier; inverting terminal $V_{\text{BAT}} = 0.9\text{ V to }1.7\text{ V}$	-	-	500	nA
		microphone preamplifier; $V_{\text{BAT}} = 0.9\text{ V to }1.7\text{ V}$	-	-	500	nA
$V_{\text{OH}}$	HIGH-level output voltage	music amplifier and noise reduction microphone preamplifier; $I_{\text{OH}} = 1\text{ mA}$ ; $V_{\text{BAT}} = 0.9\text{ V to }1.7\text{ V}$	2.6	-	-	V
$V_{\text{OL}}$	LOW-level output voltage	music amplifier and noise reduction microphone preamplifier; $I_{\text{OH}} = 1\text{ mA}$ ; $V_{\text{BAT}} = 0.9\text{ V to }1.7\text{ V}$	-	-	0.35	V
$V_{\text{ref}}$	reference voltage	$V_{\text{BAT}} = 0.9\text{ V to }1.7\text{ V}$	-	$0.5V_{\text{bst}}$	-	V
$I_{\text{DD}}$	supply current	AC grounded; no load	[1]	-	-	-
		$V_{\text{BAT}} = 1.7\text{ V}$	-	5.0	6.0	mA
		$V_{\text{BAT}} = 1.5\text{ V}$	-	6.0	-	mA
		$V_{\text{BAT}} = 1.3\text{ V}$	-	7.0	-	mA
		$V_{\text{BAT}} = 1.05\text{ V}$	-	8.0	-	mA
		$V_{\text{BAT}} = 0.9\text{ V}$	-	9.0	11	mA
$R_{\text{DSon}}$	drain-source on-state resistance	$V_{\text{BAT}} = 0.9\text{ V to }1.7\text{ V}$ ; no load	-	2.8	-	$\Omega$
$f_{\text{sw}}$	switching frequency	$V_{\text{BAT}} = 0.9\text{ V to }1.7\text{ V}$	250	300	350	kHz
$G_{v(\text{cl})}$	closed-loop voltage gain	with noise reduction microphone circuit; $V_{\text{BAT}} = 0.9\text{ V to }1.7\text{ V}$ ; $R_{\text{F}} = 18\text{ k}\Omega$	-	25	-	dB
$V_{\text{th}(\text{mute})}$	mute threshold voltage	$V_{\text{BAT}} = 0.9\text{ V to }1.7\text{ V}$	-	-	-	-
		LOW-level; active LOW (muted)	0	-	0.8	V
		HIGH-level; inactive HIGH (unmuted)	1.0	-	-	V

[1] Music amplifier at unity gain; noise preamplifier at 25 dB gain; noise preamplifier output connected to corresponding inverting input of music amplifier; non-inverting inputs.

Table 6. Operating characteristics

Symbol	Parameter	Conditions	Min	Typ	Max	Unit
$\Delta V_o$	output voltage variation	per channel; $R_L = 16 \Omega$ ; $f = 1 \text{ kHz}$ ; THD+N = 10 %				
		$V_{BAT} = 1.7 \text{ V}$	-	800	-	$\text{mV}_{\text{rms}}$
		$V_{BAT} = 1.5 \text{ V}$	-	800	-	$\text{mV}_{\text{rms}}$
		$V_{BAT} = 1.05 \text{ V}$	-	550	-	$\text{mV}_{\text{rms}}$
$P_o$	output power	per channel; $f = 1 \text{ kHz}$ ; THD+N = 10 %				
		$R_L = 16 \Omega$ ; $V_{BAT} = 1.5 \text{ V}$	-	40	-	mW
		$R_L = 32 \Omega$ ; $V_{BAT} = 1.5 \text{ V}$	-	20	-	mW
		$R_L = 16 \Omega$ ; $V_{BAT} = 1.05 \text{ V}$	-	19	-	mW
THD+N	total harmonic distortion-plus-noise	$V_o = 1 \text{ V}_{\text{peak}}$ ; $f = 1 \text{ kHz}$ ; $V_{BAT} = 1.5 \text{ V to } 1.7 \text{ V}$	-	1.0	-	%
		$V_o = 620 \text{ mV}_{\text{peak}}$ ; $f = 1 \text{ kHz}$ ; $V_{BAT} = 1.05$	-	1.0	-	%
$G_{V(\text{ol})}$	open-loop voltage gain	music amplifier and noise reduction microphone preamplifier; $V_{BAT} = 1.5 \text{ V}$	-	100	-	dB
$\alpha_{\text{ct}}$	crosstalk attenuation	$f = 1 \text{ kHz}$ ; $V_{BAT} = 1.5 \text{ V}$ ; $R_g = 1 \text{ k}\Omega$ ; $R_L = 16 \Omega$ ; $V_o = 800 \text{ mV}_{\text{rms}}$	40	50	-	dB
SVRR	supply voltage ripple rejection	$V_{\text{bst(ripple)}} = 100 \text{ mV}_{\text{rms}}$ ; $G_{V(\text{cl})} = 25 \text{ dB}$ ; $f = 1 \text{ kHz}$				
		$V_{BAT} = 0.9 \text{ V}$	30	40	-	dB
		$V_{BAT} = 1.5 \text{ V}$	-	60	-	dB
$Z_i$	input impedance	microphone preamplifier; $G_{V(\text{cl})} = 25 \text{ dB}$ (from noise reduction microphone to class-D output)	-	1	-	$\text{k}\Omega$
S/N	signal-to-noise ratio	$V_{BAT} = 1.5 \text{ V}$ ; $V_o = 800 \text{ mV}_{\text{rms}}$ ; $R_L = 16 \Omega$ ; $f = 1 \text{ kHz}$	-	70	-	dB
$V_{n(\text{i})}$	input noise voltage	spectral noise; $V_{BAT} = 1.5 \text{ V}$ ; $f = 20 \text{ Hz to } 20 \text{ kHz}$ ; $G_{V(\text{cl})} = 25 \text{ dB}$ ; $R_g = 1 \text{ k}\Omega$	-	12	-	$\text{nV}/\sqrt{\text{Hz}}$
$V_{n(\text{o})}$	output noise voltage	$V_{BAT} = 1.5 \text{ V}$ ; $f = 20 \text{ Hz to } 20 \text{ kHz}$ ; inputs AC grounded; $G_{V(\text{cl})} = 25 \text{ dB}$				
		no weighting	-	26	-	$\mu\text{V}$
		A weighting	-	20	-	$\mu\text{V}$
<b>DC-to-DC boost converter</b>						
$V_i$	input voltage		1.05	-	1.7	V
$V_{I(\text{startup})\text{min}}$	minimum start-up input voltage		-	0.9	1.05	V
$V_{\text{bst}}$	boost voltage	$V_{BAT} = 1.05 \text{ V to } 1.7 \text{ V}$ ; 2.65 mA external load	2.75	3.1	3.45	V
$I_{\text{bst}(\text{load})\text{O}}$	output load boost current	$V_{BAT} = 1.05 \text{ V to } 1.7 \text{ V}$ ; $V_{\text{bst}} > 2.8 \text{ V}$	-	2.65	-	mA
$\eta_{\text{bst}}$	boost efficiency	$V_{BAT} = 1.05 \text{ V to } 1.7 \text{ V}$ ; $R_{L(\text{tot})} = 600 \Omega$	-	80	-	%

9. Typical performance curves

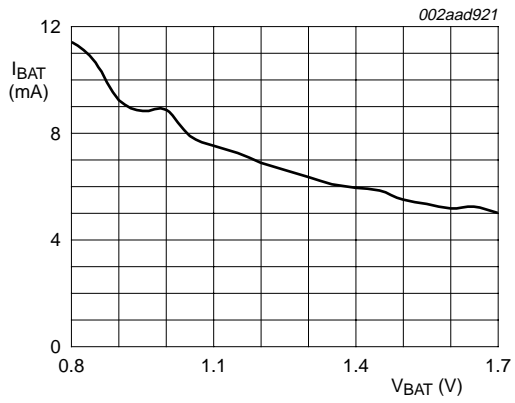

Fig 3. Battery supply current as a function of battery supply voltage

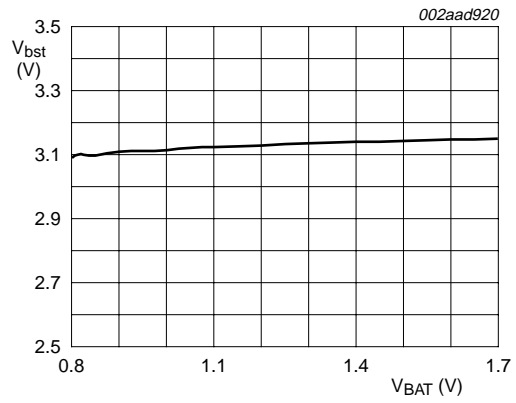

Fig 4. Boost voltage as a function of battery supply voltage

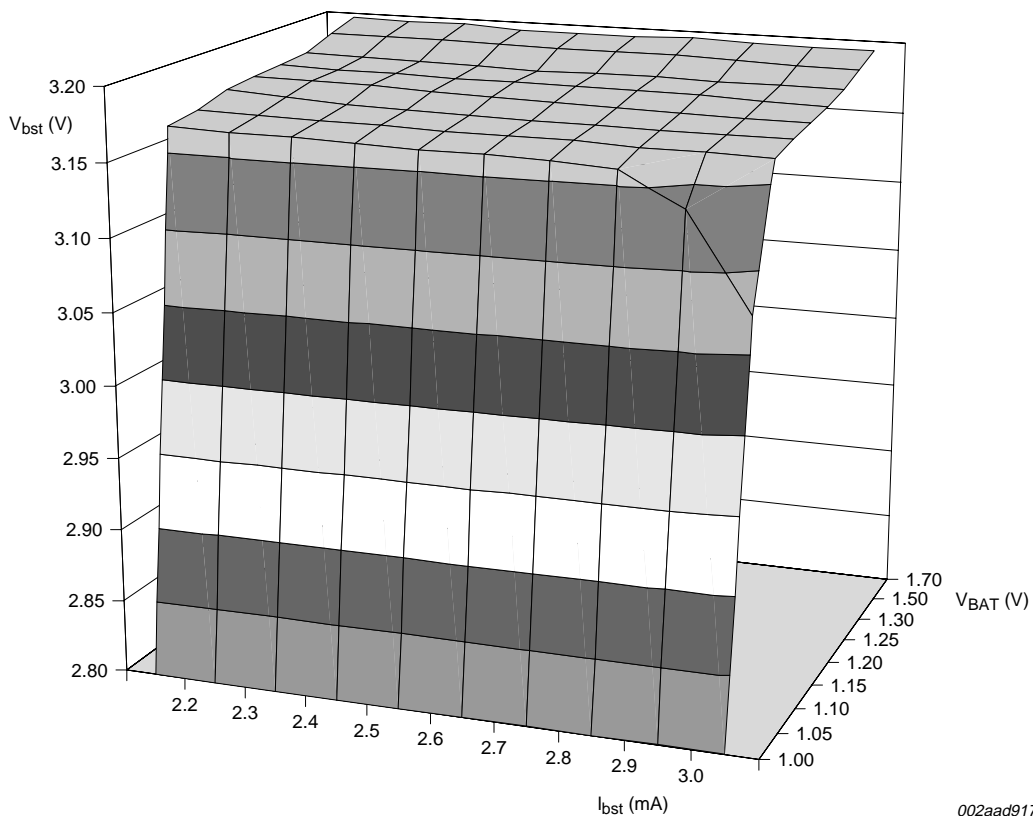
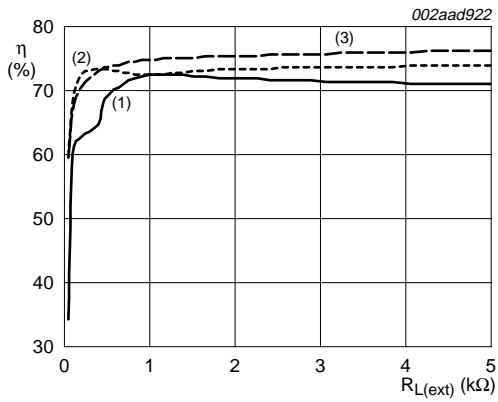
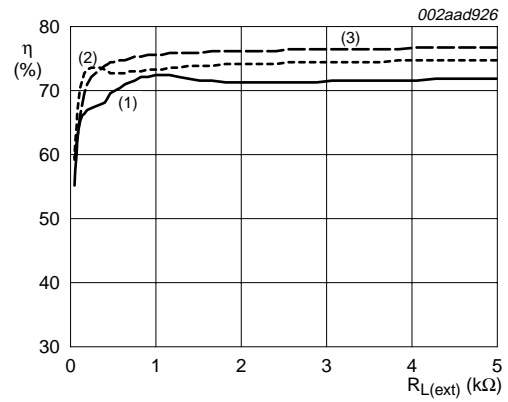

Fig 5. Boost voltage, battery supply voltage and boost current 3D profile



- (1)  $V_{BAT} = 0.9\text{ V}$
- (2)  $V_{BAT} = 1.2\text{ V}$
- (3)  $V_{BAT} = 1.5\text{ V}$

a. Battery supply voltage = 0.9 V, 1.2 V and 1.5 V



- (1)  $V_{BAT} = 1.0\text{ V}$
- (2)  $V_{BAT} = 1.3\text{ V}$
- (3)  $V_{BAT} = 1.6\text{ V}$

b. Battery supply voltage = 1.0 V, 1.3 V and 1.6 V

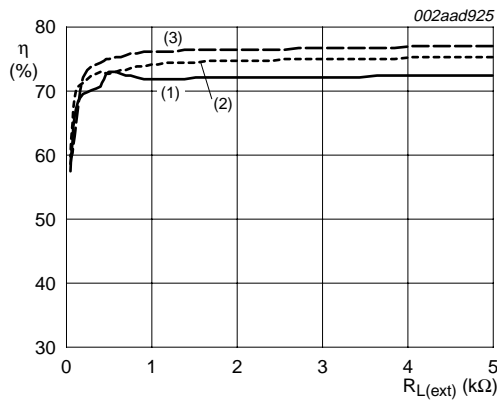

- (1)  $V_{BAT} = 1.1\text{ V}$
- (2)  $V_{BAT} = 1.4\text{ V}$
- (3)  $V_{BAT} = 1.7\text{ V}$

c. Battery supply voltage = 1.1 V, 1.4 V and 1.7 V

Fig 6. Efficiency as a function of external load resistance; boost voltage = 3.14 V

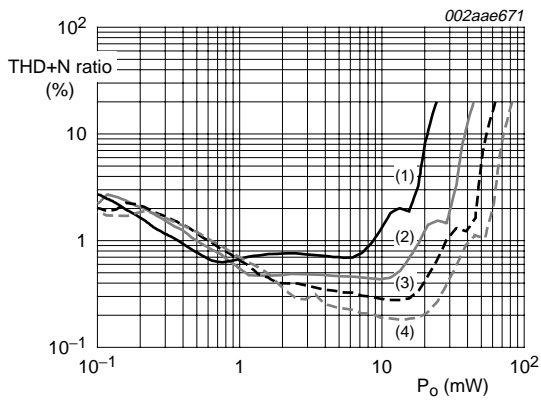

a.  $R_s = 0 \Omega$

$R_L = 16 \Omega$  speaker load +  $2 \times$  ferrite bead +  $2 \times 0 \Omega$  resistor +  $2 \times 27$  pF shunt capacitor; measured across  $16 \Omega$  speaker load;  $f_i = 1$  kHz; A-weighting filter for THD+N.

- (1)  $V_{BAT} = 1.05$  V
- (2)  $V_{BAT} = 1.3$  V
- (3)  $V_{BAT} = 1.5$  V
- (4)  $V_{BAT} = 1.7$  V

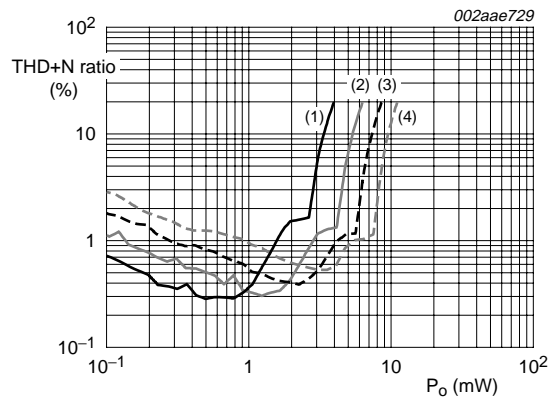

b.  $R_s = 18 \Omega$

$R_L = 16 \Omega$  speaker load +  $2 \times 15 \mu\text{H}$  inductor +  $2 \times 18 \Omega$  resistor +  $2 \times 27$  pF shunt capacitor; measured across  $16 \Omega$  speaker;  $f_i = 1$  kHz; A-weighting filter for THD+N.

- (1)  $V_{BAT} = 1.05$  V
- (2)  $V_{BAT} = 1.3$  V
- (3)  $V_{BAT} = 1.5$  V
- (4)  $V_{BAT} = 1.7$  V

Fig 7. Total harmonic distortion-plus-noise as a function of output power;  $16 \Omega$  load

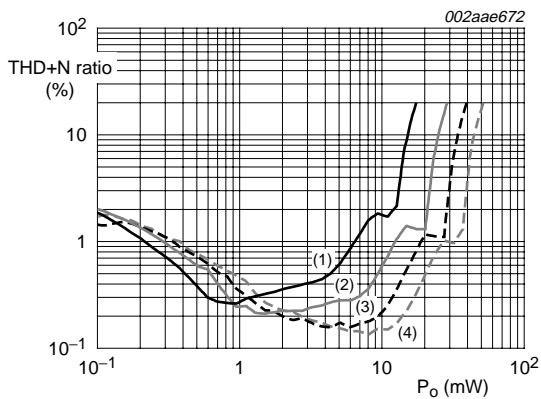

a.  $R_s = 0 \Omega$

$R_L = 32 \Omega$  speaker load +  $2 \times$  ferrite bead +  $2 \times 0 \Omega$  resistor +  $2 \times 27$  pF shunt capacitor; measured across  $32 \Omega$  speaker load;  $f_i = 1$  kHz; A-weighting filter for THD+N

- (1)  $V_{BAT} = 1.05$  V
- (2)  $V_{BAT} = 1.3$  V
- (3)  $V_{BAT} = 1.5$  V
- (4)  $V_{BAT} = 1.7$  V

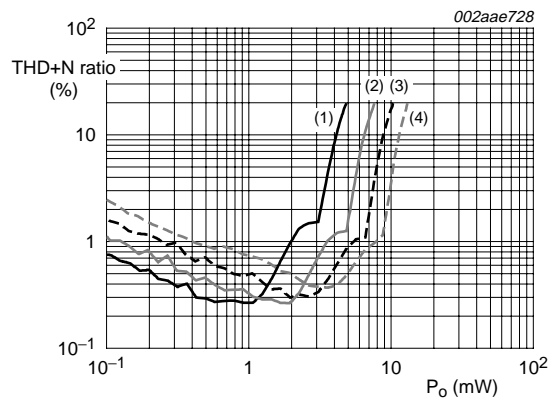

b.  $R_s = 18 \Omega$

$R_L = 32 \Omega$  speaker load +  $2 \times 15 \mu\text{H}$  inductor +  $2 \times 18 \Omega$  resistor +  $2 \times 27$  pF shunt capacitor; measured across  $32 \Omega$  speaker;  $f_i = 1$  kHz; A-weighting filter for THD+N

- (1)  $V_{BAT} = 1.05$  V
- (2)  $V_{BAT} = 1.3$  V
- (3)  $V_{BAT} = 1.5$  V
- (4)  $V_{BAT} = 1.7$  V

Fig 8. Total harmonic distortion-plus-noise as a function of output power;  $32 \Omega$  load

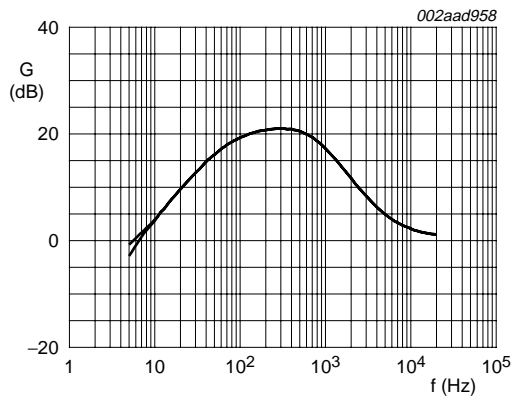

$V_{\text{NMIC\_IN}} = 6.3 \text{ mV}_{\text{rms}}$ ;  $V_{\text{bst}} = 3 \text{ V}$ ;  $V_{\text{BAT}} = 1.5 \text{ V}$

**Fig 9.** Gain as a function of frequency response of feedforward noise reduction circuit; NMIC\_INx to MA\_OUTx for feedforward application circuit

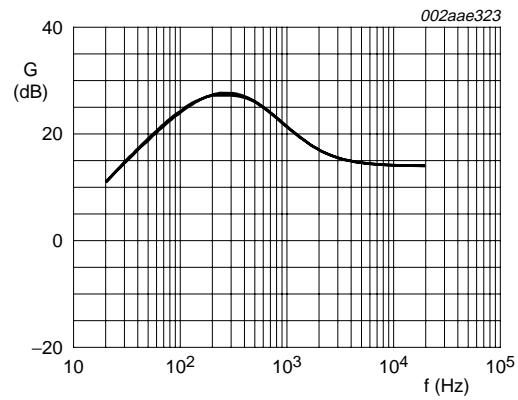

$V_{\text{NMIC\_IN}} = 10 \text{ mV to } 50 \text{ mV}$ ;  $V_{\text{BAT}} = 1.5 \text{ V}$ ;  $V_{\text{bst}} = 3.1 \text{ V}$

**Fig 10.** Gain as a function of frequency; NMIC\_INx to MA\_OUTx for feedback application circuit

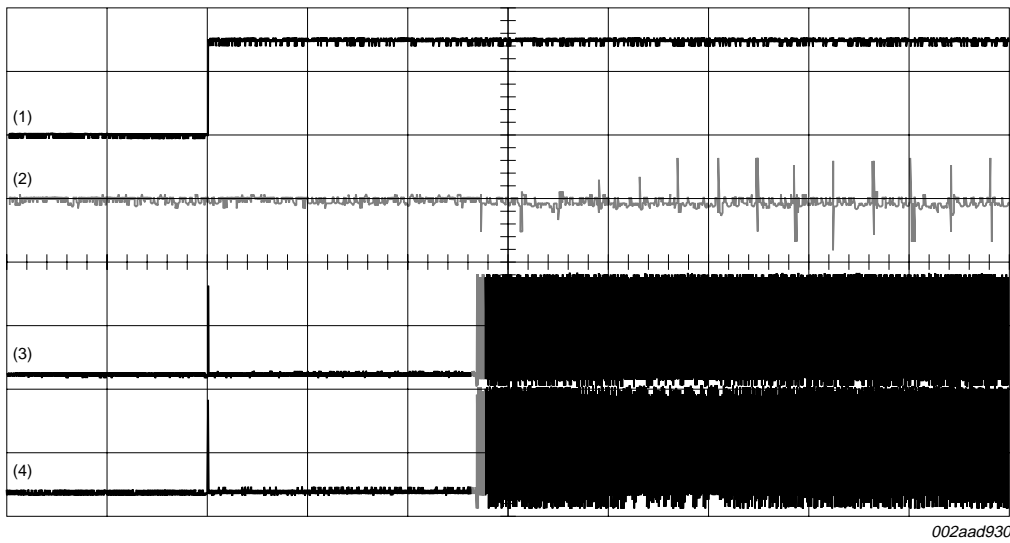

At start-up, no signal on music input. No pop or click. The small glitches on trace (2) are just noise from the noise reduction amplifier feed-through. Start-up delay approximately 135 ms.

- (1) VBAT switch ON to 1.5 V (50 ms; 1.0 V)
- (2) Difference between trace (3) and (4), which equates to the pop or click (0.5 ms; 0.54 V)
- (3) OUTLP (50 ms; 1.0 V)
- (4) OUTLN (50 ms; 1.0 V)

Fig 11. Power-on delay and pop-on noise performance

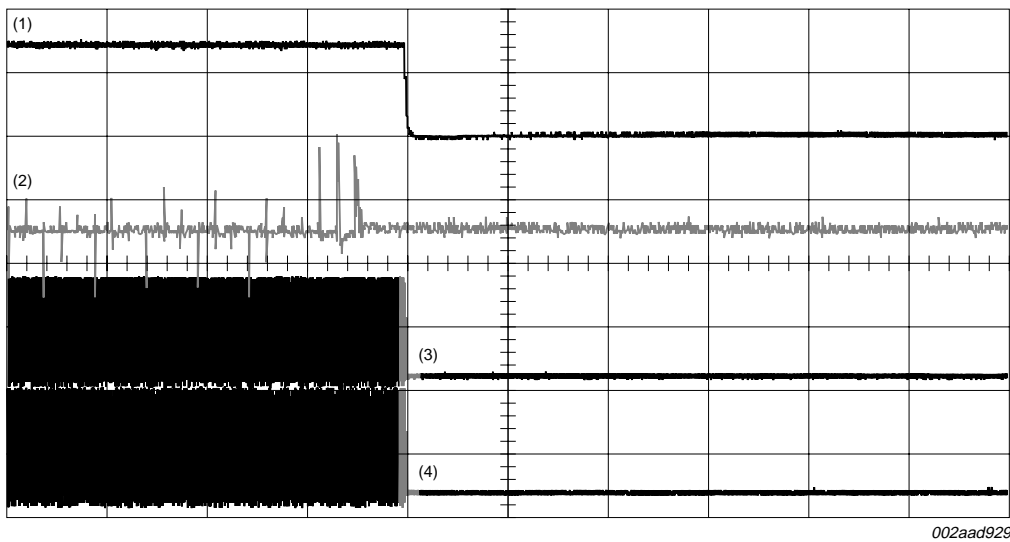

- (1) 50 ms; 1.0 V
- (2) 1 ms; 0.5 V
- (3) 50 ms; 1.0 V
- (4) 50 ms; 1.0 V

Fig 12. Pop-off click performance

## 10. Application information

### 10.1 General application description

The NE58633 is a stereo noise reduction IC with a boost converter output at 3.2 V with 2.5 mA load current. Using the on-chip boost converter, it operates from a single cell alkaline battery (0.9 V to 1.7 V). The NE58633 is optimized for low current consumption at 6 mA quiescent current for  $V_{BAT} = 1.5$  V.

Each channel is comprised of a low noise preamplifier which is driven by an electret microphone, a music amplifier and class-D, BTL headphone driver amplifier (see [Figure 1 "Block diagram"](#)).

The NE58633 output drivers are capable of driving 800 mV<sub>rms</sub> across 16 Ω and 32 Ω loads. THD+N performance is 1 % at  $V_O = 1 V_M$  and 10 % THD+N at 800 mV<sub>rms</sub> output voltage driving 16 Ω at a battery voltage of 1.5 V.

The internal reference voltage is set for  $\frac{1}{2} V_{bst}$  and is pinned out so it can be externally decoupled to enhance noise performance. The NE58633 differential architecture provides immunity to noise. The output noise is typically 26 μV<sub>rms</sub> for  $G_{V(cl)} = 25$  dB.

The NE58633 provides ESD and short-circuit protection. It features mute control and plop and click reduction circuitry.

As shown in the application circuit schematics ([Figure 13](#) and [Figure 14](#)), the NE58633 may be used for Active Noise Reduction (ANR) in either feedforward or feedback noise-cancelling headphones and earphones in consumer and industrial applications. The gain and filter characteristics of the ANR circuit are set using external resistors and capacitors.



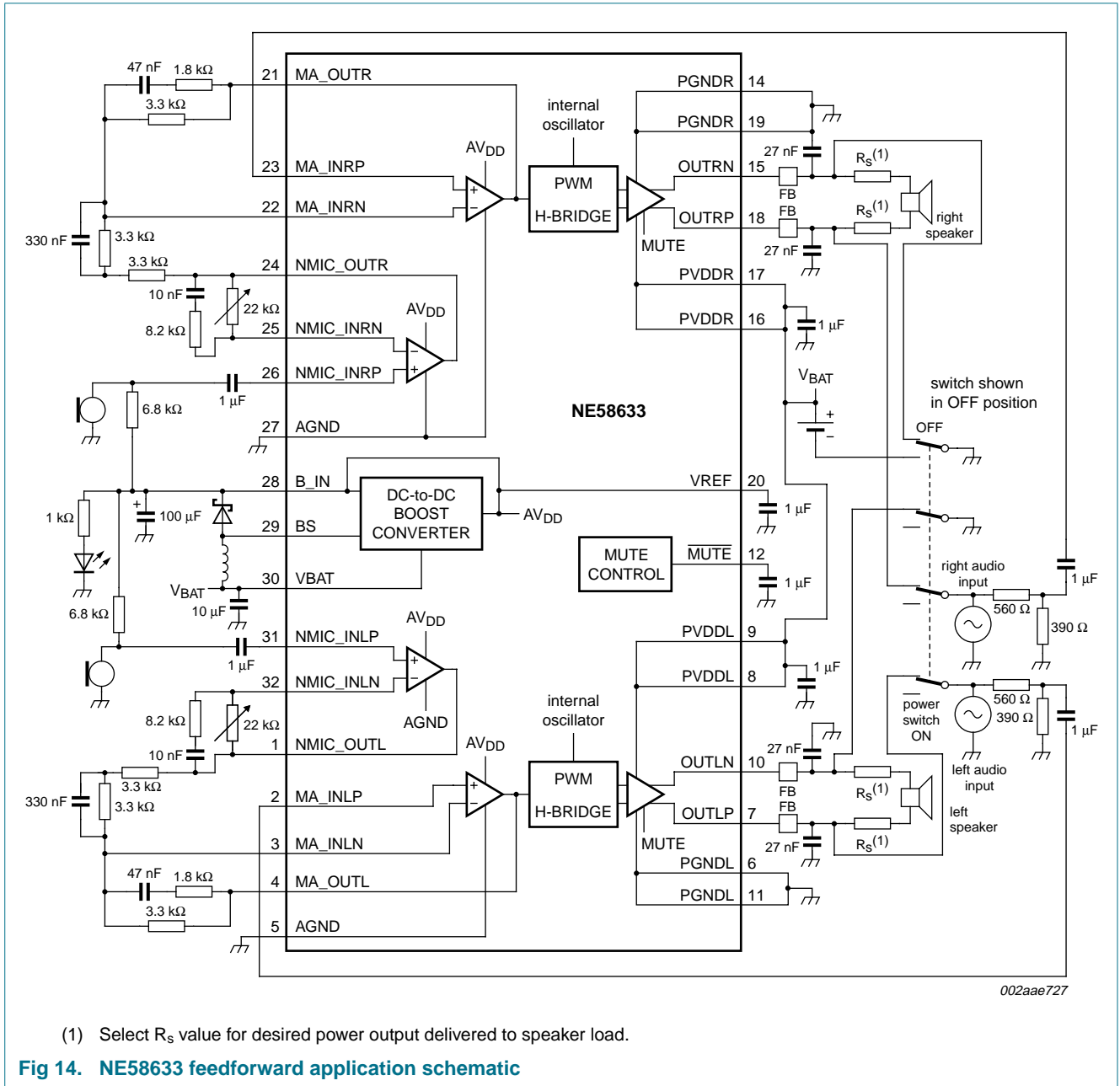

Fig 14. NE58633 feedforward application schematic

## 10.2 Power supply decoupling

The power supply pins B\_IN, PVDDL and PVDDR are decoupled with 1  $\mu$ F capacitors directly from the pins to ground.

## 10.3 Speaker output filtering considerations

The ferrite beads form a low-pass filter with a shunt capacitor to reduce radio frequency > 1 MHz. Choose a ferrite bead with high-impedance at high frequencies and low-impedance at low frequencies. A typical ferrite bead is 600  $\Omega$  at 100 MHz. A shunt capacitor is added after the ferrite bead to complete the low-pass filter. The low frequency impedance is not as important as in power amplifiers because headphone speakers are stabilized with a series impedance of about 18  $\Omega$  on each output. The series resistors,  $R_s$ , may be decreased to increase the power delivered to the speaker load. [Figure 7](#) and [Figure 8](#) show the THD+N versus  $P_o$  performance for  $R_s = 0 \Omega$  and  $R_s = 18 \Omega$ .

## 10.4 Boost converter and layout considerations

### 10.4.1 Boost converter operation

The boost converter operates in asynchronous mode as shown in [Figure 15](#). As  $V_{BAT}$  drops, the boost converter efficiency decreases (see [Figure 3](#) and [Figure 6](#)). The boost converter is capable of driving 2.65 mA external load (see [Figure 5](#)).

If the NE58633 is operated without the boost converter, pins B\_IN, PVDDL and PVDDR may be powered directly from a 3 V power supply source such as 2 AAA alkaline batteries. The VBAT pin is not used.

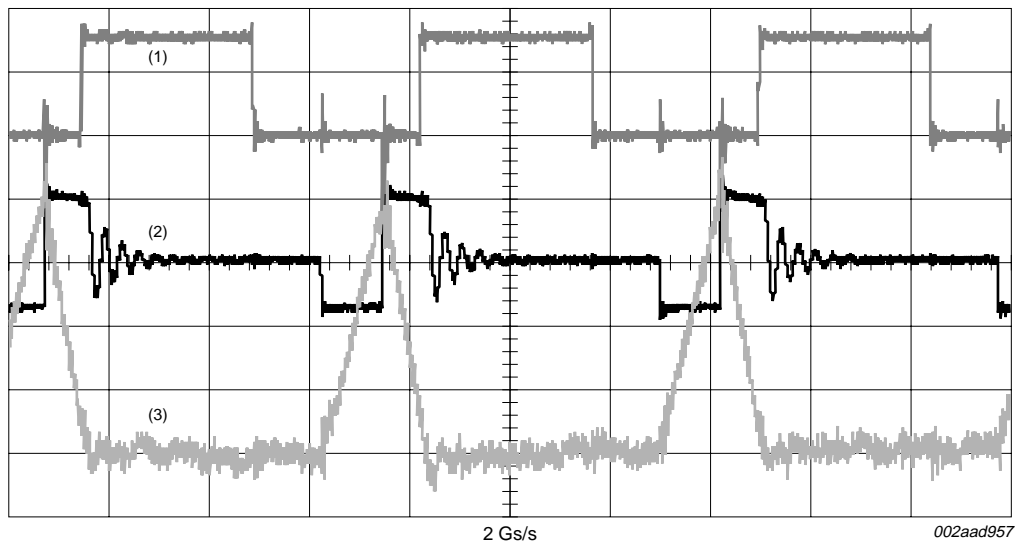

(1) Positive or negative output of the class-D driver with  $V_{BAT}$  at 1.5 V.

(2) Pin BS ( $V_{BS} = V_{bst}$ ).

**Remark:** This is a normal pulse. It does not change with  $V_{BAT}$  but remains at the level of the boosted voltage.

(3) Current at pin B\_IN ( $I_{bst(load)O}$ ) measures approximately 40 mA peak, but averaged DC current is a few milliamperes per the specification.

Fig 15. Switching waveform at the BS pin

#### 10.4.2 Critical layout consideration and component selection

The trace between pin BS and the switching inductor must be kept as short as possible. The VBAT side of the boost switching inductor is decoupled by use of a low Equivalent Series Resistance (ESR) 10  $\mu$ F, 6 V capacitor. A power inductor with low ESR (typically 50 m $\Omega$ ) should be used. The boost inductor must be 22  $\mu$ H minimum and 47  $\mu$ H maximum to ensure proper operation. Pin B\_IN is decoupled by use of a 1  $\mu$ F capacitor directly at the pin with 33  $\mu$ F to 47  $\mu$ F at the  $V_{bst}$  output at the Schottky diode.

#### 10.5 Mute

Mute may be invoked by directly grounding the pin with a momentary switch. The  $\overline{\text{MUTE}}$  pin is active LOW. The outputs are muted automatically when  $V_{BAT}$  is less than or equal to 0.9 V. The  $\overline{\text{MUTE}}$  pin is decoupled to ground with a 1  $\mu$ F capacitor.

#### 10.6 Internal reference, VREF pin

The internal reference is pinned out so it can be filtered with a capacitor to ground. The recommended value is 1  $\mu$ F to 10  $\mu$ F. Ensure that the biasing time constant at pin VREF does not exceed the power-on delay time or a pop-on click will heard.

#### 10.7 Power-on delay time and pop and click performance

Power-on delay time of typically 135 ms is imposed to allow the input biasing to power-up and stabilize. This eliminates pop-on noise.

#### 10.8 Active Noise Reduction (ANR) concepts

##### 10.8.1 Basic concept

Noise reduction headphones utilize Passive Noise Reduction (PNR) provided by the passive noise reduction of the headphone acoustical plant alone. The amount of PNR is greatest at the high frequencies and least at the low frequencies. The addition of Active Noise Reduction (ANR) greatly increases the amount of noise reduction at low frequencies. The combined effect of PNR and ANR provides noise reduction over an appreciable hearing range. [Figure 16](#) shows the combined effect of both PNR and ANR in an over-the-ear noise-cancelling FB headphone.

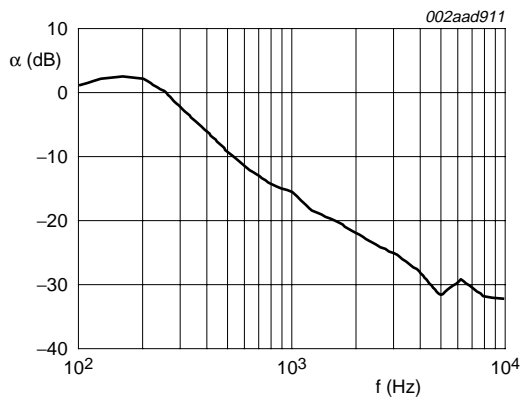

a. Passive attenuation left

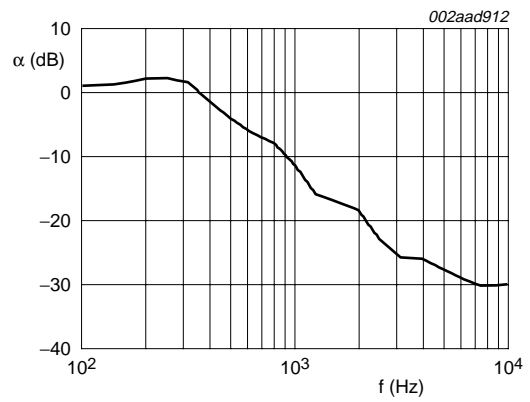

b. Passive attenuation right

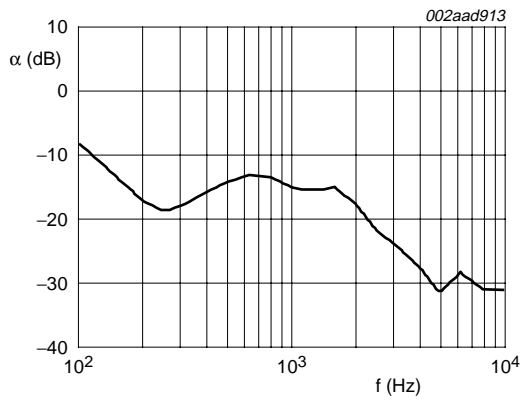

c. Total attenuation left

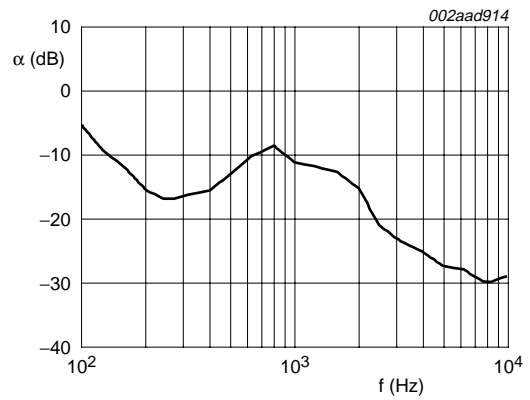

d. Total attenuation right

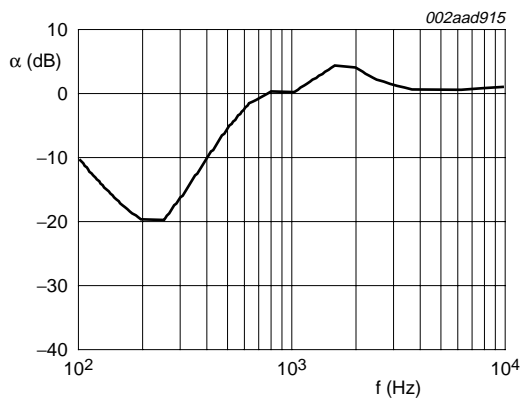

e. Active attenuation left

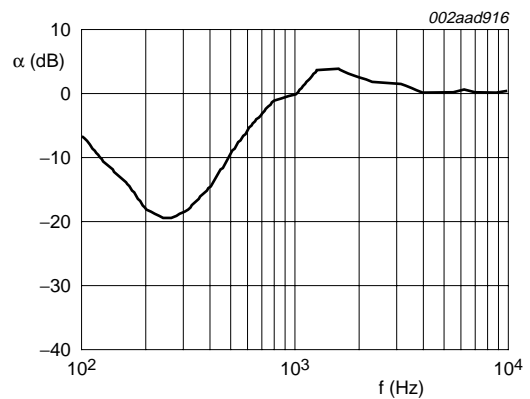

f. Active attenuation right

Fig 16. Combined noise reduction (PNR + ANR) of typical over-the-ear FB application

## 10.8.2 Feedforward circuit

### 10.8.2.1 Conceptual diagram of feedforward application

Figure 17 shows the typical feedforward application diagram in which the noise cancelling microphone samples the noise outside the acoustic plant of the headphone or earphone.

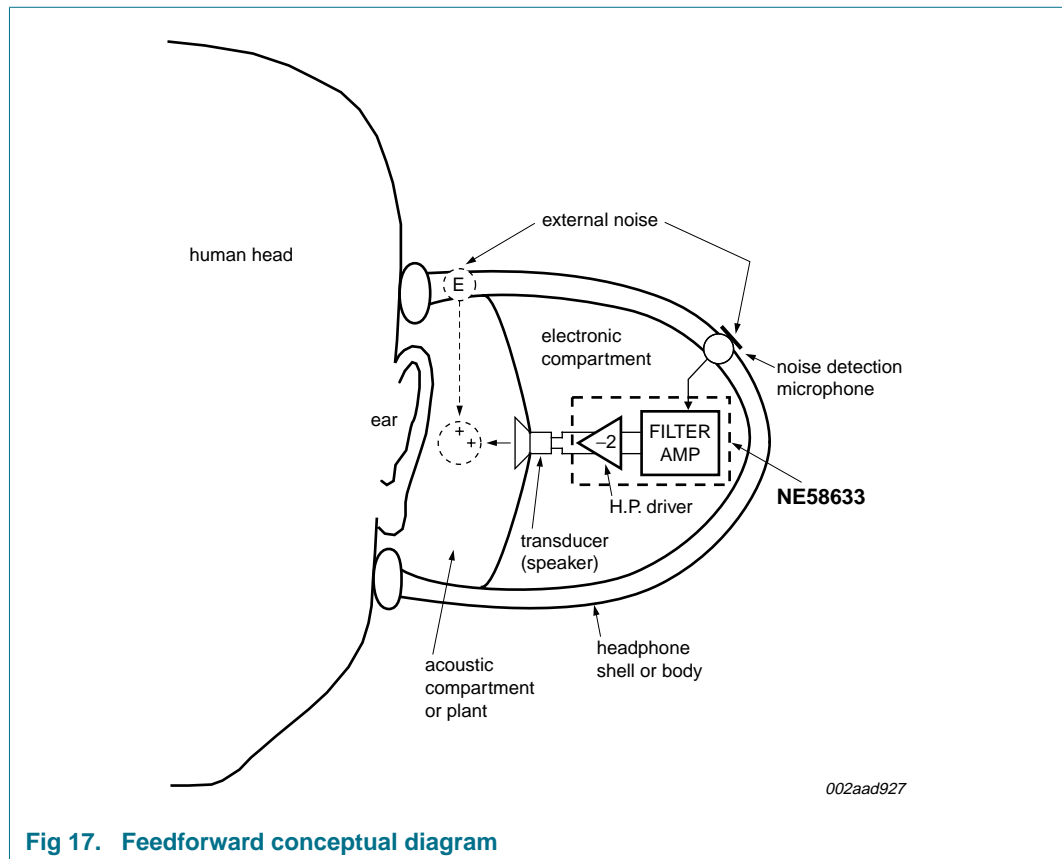

Fig 17. Feedforward conceptual diagram

This method produces a noise-cancelling signal that tries to replicate the noise in the acoustical plant at the loudspeaker and entrance to the ear. The replication is never exact because the microphone is located outside the headphones; the noise sampled is not a perfect replica of the noise inside the ear cup, which is altered by passing through the ear cup as well as by the internal reflections. In fact, in some cases the anti-noise may actually introduce noise inside the headphones.

The headphone loudspeaker or transducer is used to send the normal audio signal as well as the feedforward signal providing noise cancellation. The microphone detects the external noise and its output is amplified and filtered, and phase is inverted by the low noise preamplifier and music amplifier in the NE58633.

### 10.8.2.2 Feedforward demo board schematic

The evaluation demo board uses a typical filter design and may not yield the optimal noise cancelling performance for a given headphone mechanical-acoustical plant.

### 10.8.3 Feedback circuit

#### 10.8.3.1 Conceptual diagram of feedback application

Figure 18 shows the typical feedback application diagram in which the noise cancelling microphone samples the noise and music inside the acoustical plant.

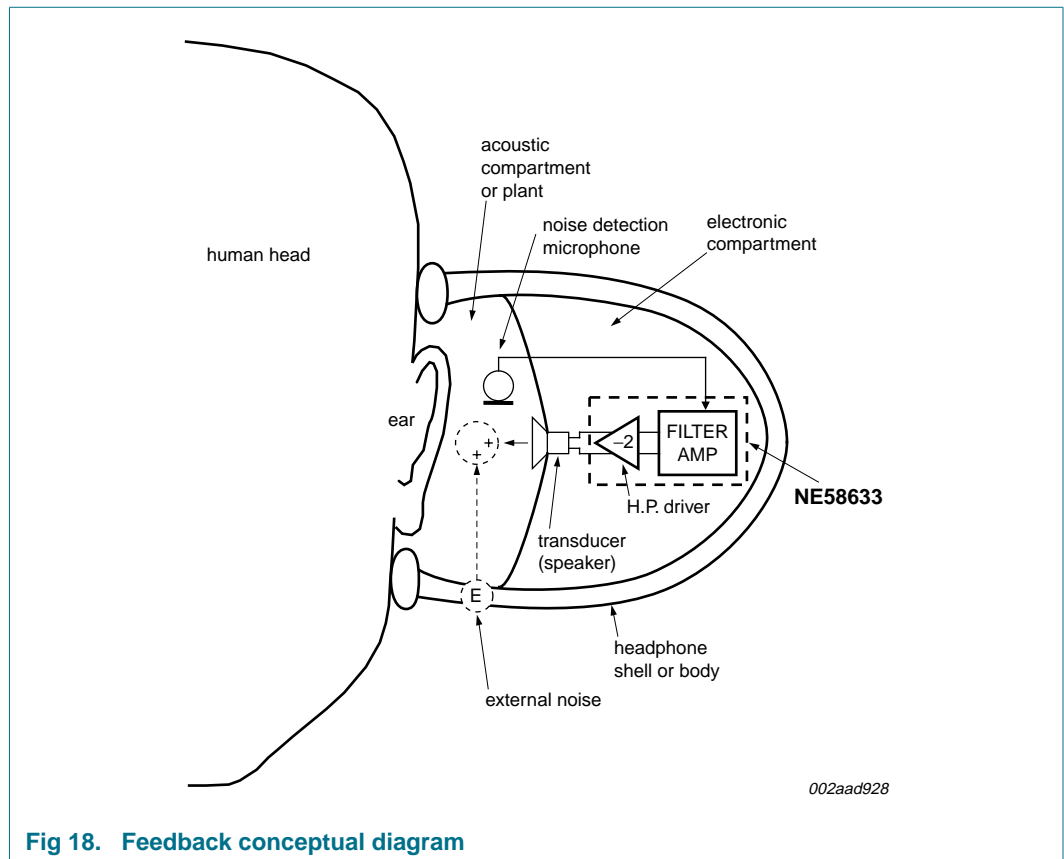

Fig 18. Feedback conceptual diagram

The feedback solution employs a low cost, battery operated analog Active Noise Reduction (ANR) technique. The topology uses negative feedback circuitry in which the noise reduction microphone is placed close to the ear and headphone loudspeaker. By detecting the noise with the microphone in the position closer to the ear, a noise cancelling effect with high accuracy is realized. This technique produces a noise cancelling signal that always minimizes the noise in the ear canal or entrance to the ear canal. The audio signal is analyzed with exact timing with the noise cancelling signal. The noise cancelling signal increases with increasing noise level.

The headphone loudspeaker or transducer is used to send the normal audio signal as well as the feedback signal providing noise cancellation. The microphone is placed near the loudspeaker and its output is amplified, filtered, and phase inverted by the feedback network and sent back to the loudspeaker.

The design of the feedback filter for a given headphone plant involves a trade-off between performance on one hand and stability and robustness with respect to variations of the headphone plant on the other. Traditional feedback design methods use filter elements such as, lead, lag and notch filters which are appropriately tuned to shape the audio response of the system to obtain good performance with sufficient stability margins.

Since the attenuation performance of an analog ANR headphone is defined in the design stage, it has limited applicability to work in different environments. Overall noise cancelling performance is achieved by first characterizing the passive attenuation of headphone plant and then designing the ANR circuitry to obtain the optimal overall noise reduction performance and stability. Figure 16 shows combined noise reduction results of typical over-the-ear feedback headphone. The combined noise reduction is the sum of the PNR of the plant and the active noise reduction of the feedback filter circuit.

### 10.8.3.2 Feedback demo board schematic

The evaluation demo board embodies a typical filter design and may not yield the optimal noise cancelling performance for a given headphone mechanical-acoustical plant.

## 11. Test information

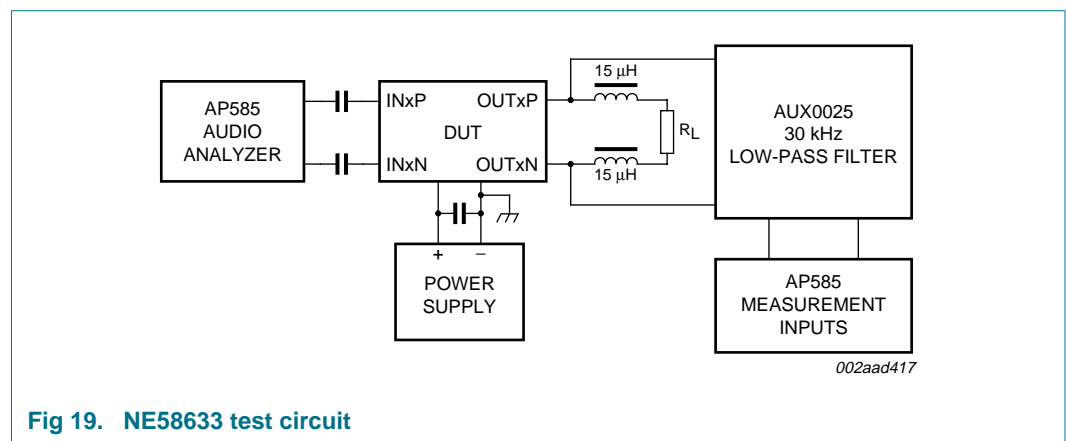

Fig 19. NE58633 test circuit

## 12. Package outline

HVQFN32: plastic thermal enhanced very thin quad flat package; no leads;  
32 terminals; body 5 x 5 x 0.85 mm

SOT617-1

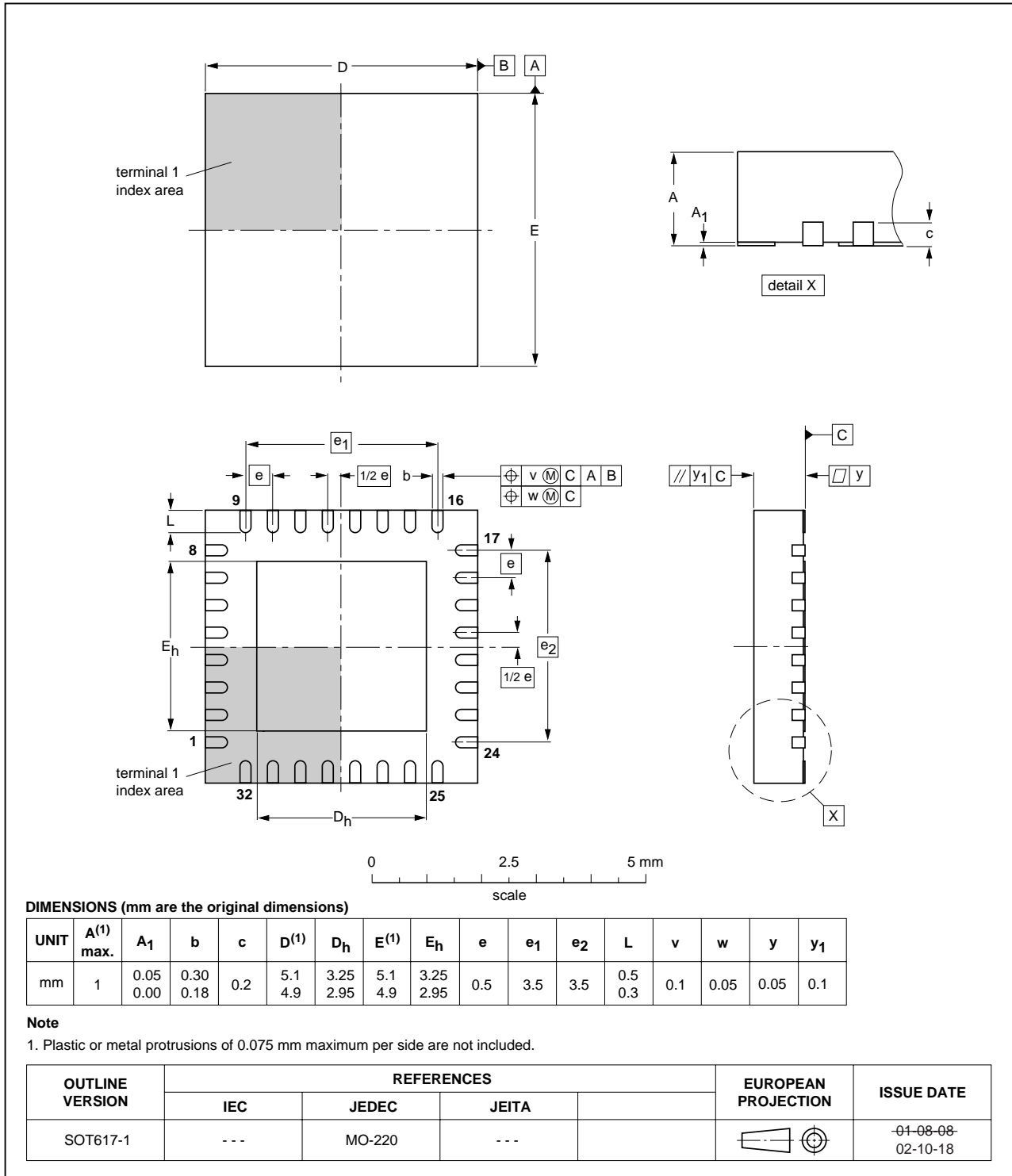

Fig 20. Package outline SOT617-1 (HVQFN32)

## 13. Soldering of SMD packages

This text provides a very brief insight into a complex technology. A more in-depth account of soldering ICs can be found in Application Note *AN10365 "Surface mount reflow soldering description"*.

### 13.1 Introduction to soldering

Soldering is one of the most common methods through which packages are attached to Printed Circuit Boards (PCBs), to form electrical circuits. The soldered joint provides both the mechanical and the electrical connection. There is no single soldering method that is ideal for all IC packages. Wave soldering is often preferred when through-hole and Surface Mount Devices (SMDs) are mixed on one printed wiring board; however, it is not suitable for fine pitch SMDs. Reflow soldering is ideal for the small pitches and high densities that come with increased miniaturization.

### 13.2 Wave and reflow soldering

Wave soldering is a joining technology in which the joints are made by solder coming from a standing wave of liquid solder. The wave soldering process is suitable for the following:

- Through-hole components
- Leaded or leadless SMDs, which are glued to the surface of the printed circuit board

Not all SMDs can be wave soldered. Packages with solder balls, and some leadless packages which have solder lands underneath the body, cannot be wave soldered. Also, leaded SMDs with leads having a pitch smaller than ~0.6 mm cannot be wave soldered, due to an increased probability of bridging.

The reflow soldering process involves applying solder paste to a board, followed by component placement and exposure to a temperature profile. Leaded packages, packages with solder balls, and leadless packages are all reflow solderable.

Key characteristics in both wave and reflow soldering are:

- Board specifications, including the board finish, solder masks and vias
- Package footprints, including solder thieves and orientation
- The moisture sensitivity level of the packages
- Package placement
- Inspection and repair
- Lead-free soldering versus SnPb soldering

### 13.3 Wave soldering

Key characteristics in wave soldering are:

- Process issues, such as application of adhesive and flux, clinching of leads, board transport, the solder wave parameters, and the time during which components are exposed to the wave
- Solder bath specifications, including temperature and impurities

### 13.4 Reflow soldering

Key characteristics in reflow soldering are:

- Lead-free versus SnPb soldering; note that a lead-free reflow process usually leads to higher minimum peak temperatures (see [Figure 21](#)) than a SnPb process, thus reducing the process window
- Solder paste printing issues including smearing, release, and adjusting the process window for a mix of large and small components on one board
- Reflow temperature profile; this profile includes preheat, reflow (in which the board is heated to the peak temperature) and cooling down. It is imperative that the peak temperature is high enough for the solder to make reliable solder joints (a solder paste characteristic). In addition, the peak temperature must be low enough that the packages and/or boards are not damaged. The peak temperature of the package depends on package thickness and volume and is classified in accordance with [Table 7](#) and [8](#)

**Table 7. SnPb eutectic process (from J-STD-020C)**

Package thickness (mm)	Package reflow temperature (°C)	
	Volume (mm <sup>3</sup> )	
	< 350	≥ 350
< 2.5	235	220
≥ 2.5	220	220

**Table 8. Lead-free process (from J-STD-020C)**

Package thickness (mm)	Package reflow temperature (°C)		
	Volume (mm <sup>3</sup> )		
	< 350	350 to 2000	> 2000
< 1.6	260	260	260
1.6 to 2.5	260	250	245
> 2.5	250	245	245

Moisture sensitivity precautions, as indicated on the packing, must be respected at all times.

Studies have shown that small packages reach higher temperatures during reflow soldering, see [Figure 21](#).

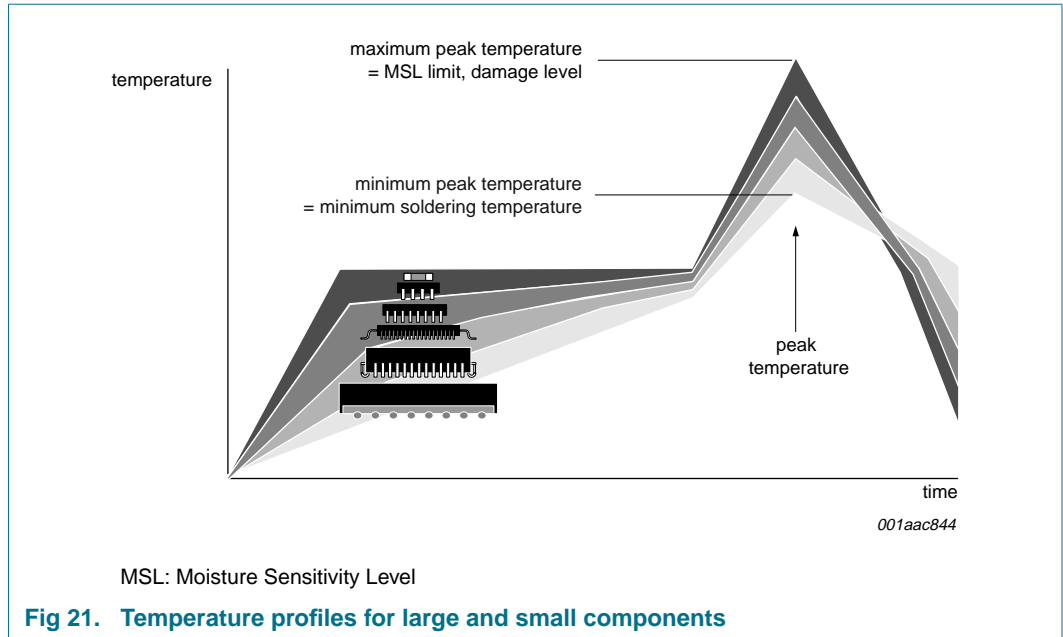

For further information on temperature profiles, refer to Application Note AN10365 "Surface mount reflow soldering description".

## 14. Abbreviations

**Table 9. Abbreviations**

Acronym	Description
ANR	Active Noise Reduction
BTL	Bridge Tied Load
DUT	Device Under Test
ESD	ElectroStatic Discharge
ESR	Equivalent Series Resistance
FB	FeedBack
RMS	Root Mean Squared
PNR	Passive Noise Reduction
PWM	Pulse Width Modulation

## 15. Revision history

Table 10. Revision history

Document ID	Release date	Data sheet status	Change notice	Supersedes
NE58633_2	20090525	Product data sheet	-	NE58633_1
Modifications:	<ul style="list-style-type: none"> <li>• <a href="#">Figure 7</a> updated (7a and 7b)</li> <li>• <a href="#">Figure 8</a> updated (8a and 8b)</li> <li>• <a href="#">Table 6 "Operating characteristics"</a>:                             <ul style="list-style-type: none"> <li>– symbol <math>\Delta V_o</math>, output voltage variation: changed unit from "<math>V_{rms}</math>" to "<math>mV_{rms}</math>"</li> <li>– added specification for S/N, signal-to-noise ratio</li> </ul> </li> <li>• <a href="#">Figure 13 "NE58633 feedback application schematic"</a> modified: changed "<math>18 \Omega</math>" resistors on outputs to "<math>R_s</math>" and added <a href="#">Figure note [1]</a> and references to it</li> <li>• <a href="#">Figure 14 "NE58633 feedforward application schematic"</a> modified: changed "<math>18 \Omega</math>" resistors on outputs to "<math>R_s</math>" and added <a href="#">Figure note [1]</a> and references to it</li> <li>• <a href="#">Section 10.3 "Speaker output filtering considerations"</a> is re-written</li> </ul>			
NE58633_1	20090122	Product data sheet	-	-

## 16. Legal information

### 16.1 Data sheet status

Document status <sup>[1][2]</sup>	Product status <sup>[3]</sup>	Definition
Objective [short] data sheet	Development	This document contains data from the objective specification for product development.
Preliminary [short] data sheet	Qualification	This document contains data from the preliminary specification.
Product [short] data sheet	Production	This document contains the product specification.

[1] Please consult the most recently issued document before initiating or completing a design.

[2] The term 'short data sheet' is explained in section "Definitions".

[3] The product status of device(s) described in this document may have changed since this document was published and may differ in case of multiple devices. The latest product status information is available on the Internet at URL <http://www.nxp.com>.

### 16.2 Definitions

**Draft** — The document is a draft version only. The content is still under internal review and subject to formal approval, which may result in modifications or additions. NXP Semiconductors does not give any representations or warranties as to the accuracy or completeness of information included herein and shall have no liability for the consequences of use of such information.

**Short data sheet** — A short data sheet is an extract from a full data sheet with the same product type number(s) and title. A short data sheet is intended for quick reference only and should not be relied upon to contain detailed and full information. For detailed and full information see the relevant full data sheet, which is available on request via the local NXP Semiconductors sales office. In case of any inconsistency or conflict with the short data sheet, the full data sheet shall prevail.

### 16.3 Disclaimers

**General** — Information in this document is believed to be accurate and reliable. However, NXP Semiconductors does not give any representations or warranties, expressed or implied, as to the accuracy or completeness of such information and shall have no liability for the consequences of use of such information.

**Right to make changes** — NXP Semiconductors reserves the right to make changes to information published in this document, including without limitation specifications and product descriptions, at any time and without notice. This document supersedes and replaces all information supplied prior to the publication hereof.

**Suitability for use** — NXP Semiconductors products are not designed, authorized or warranted to be suitable for use in medical, military, aircraft, space or life support equipment, nor in applications where failure or malfunction of an NXP Semiconductors product can reasonably be expected to result in personal injury, death or severe property or environmental

damage. NXP Semiconductors accepts no liability for inclusion and/or use of NXP Semiconductors products in such equipment or applications and therefore such inclusion and/or use is at the customer's own risk.

**Applications** — Applications that are described herein for any of these products are for illustrative purposes only. NXP Semiconductors makes no representation or warranty that such applications will be suitable for the specified use without further testing or modification.

**Limiting values** — Stress above one or more limiting values (as defined in the Absolute Maximum Ratings System of IEC 60134) may cause permanent damage to the device. Limiting values are stress ratings only and operation of the device at these or any other conditions above those given in the Characteristics sections of this document is not implied. Exposure to limiting values for extended periods may affect device reliability.

**Terms and conditions of sale** — NXP Semiconductors products are sold subject to the general terms and conditions of commercial sale, as published at <http://www.nxp.com/profile/terms>, including those pertaining to warranty, intellectual property rights infringement and limitation of liability, unless explicitly otherwise agreed to in writing by NXP Semiconductors. In case of any inconsistency or conflict between information in this document and such terms and conditions, the latter will prevail.

**No offer to sell or license** — Nothing in this document may be interpreted or construed as an offer to sell products that is open for acceptance or the grant, conveyance or implication of any license under any copyrights, patents or other industrial or intellectual property rights.

**Export control** — This document as well as the item(s) described herein may be subject to export control regulations. Export might require a prior authorization from national authorities.

### 16.4 Trademarks

Notice: All referenced brands, product names, service names and trademarks are the property of their respective owners.

## 17. Contact information

For more information, please visit: <http://www.nxp.com>

For sales office addresses, please send an email to: [salesaddresses@nxp.com](mailto:salesaddresses@nxp.com)

## 18. Contents

<b>1</b>	<b>General description</b> .....	<b>1</b>	<b>16.4</b>	<b>Trademarks</b> .....	<b>26</b>
<b>2</b>	<b>Features</b> .....	<b>1</b>	<b>17</b>	<b>Contact information</b> .....	<b>26</b>
<b>3</b>	<b>Ordering information</b> .....	<b>2</b>	<b>18</b>	<b>Contents</b> .....	<b>27</b>
<b>4</b>	<b>Block diagram</b> .....	<b>2</b>			
<b>5</b>	<b>Pinning information</b> .....	<b>3</b>			
5.1	Pinning .....	3			
5.2	Pin description .....	3			
<b>6</b>	<b>Limiting values</b> .....	<b>4</b>			
<b>7</b>	<b>Recommended operating conditions</b> .....	<b>4</b>			
<b>8</b>	<b>Characteristics</b> .....	<b>5</b>			
<b>9</b>	<b>Typical performance curves</b> .....	<b>7</b>			
<b>10</b>	<b>Application information</b> .....	<b>12</b>			
10.1	General application description .....	12			
10.2	Power supply decoupling .....	15			
10.3	Speaker output filtering considerations .....	15			
10.4	Boost converter and layout considerations .....	15			
10.4.1	Boost converter operation .....	15			
10.4.2	Critical layout consideration and component selection .....	16			
10.5	Mute .....	16			
10.6	Internal reference, VREF pin .....	16			
10.7	Power-on delay time and pop and click performance .....	16			
10.8	Active Noise Reduction (ANR) concepts .....	16			
10.8.1	Basic concept .....	16			
10.8.2	Feedforward circuit .....	18			
10.8.2.1	Conceptual diagram of feedforward application .....	18			
10.8.2.2	Feedforward demo board schematic .....	18			
10.8.3	Feedback circuit .....	19			
10.8.3.1	Conceptual diagram of feedback application .....	19			
10.8.3.2	Feedback demo board schematic .....	20			
<b>11</b>	<b>Test information</b> .....	<b>20</b>			
<b>12</b>	<b>Package outline</b> .....	<b>21</b>			
<b>13</b>	<b>Soldering of SMD packages</b> .....	<b>22</b>			
13.1	Introduction to soldering .....	22			
13.2	Wave and reflow soldering .....	22			
13.3	Wave soldering .....	22			
13.4	Reflow soldering .....	23			
<b>14</b>	<b>Abbreviations</b> .....	<b>24</b>			
<b>15</b>	<b>Revision history</b> .....	<b>25</b>			
<b>16</b>	<b>Legal information</b> .....	<b>26</b>			
16.1	Data sheet status .....	26			
16.2	Definitions .....	26			
16.3	Disclaimers .....	26			

Please be aware that important notices concerning this document and the product(s) described herein, have been included in section 'Legal information'.



© NXP B.V. 2009.

All rights reserved.

For more information, please visit: <http://www.nxp.com>

For sales office addresses, please send an email to: [salesaddresses@nxp.com](mailto:salesaddresses@nxp.com)

Date of release: 25 May 2009

Document identifier: NE58633\_2