

SERIES 45L(R), 150K /L /KS(R)

STANDARD RECOVERY DIODES

Stud Version

Features

- Alloy diode
- High current carrying capability
- High voltage ratings up to 1000V
- High surge current capabilities
- Stud cathode and stud anode version

150A

Typical Applications

- Converters
- Power supplies
- Machine tool controls
- High power drives
- Medium traction applications

Major Ratings and Characteristics

Parameters	45L /150...	Units
$I_{F(AV)}$	150	A
@ T_C	150	°C
$I_{F(RMS)}$	235	A
I_{FSM} @ 50Hz	3570	A
@ 60Hz	3740	A
I^2t @ 50Hz	64	KA ² s
@ 60Hz	58	KA ² s
V_{RRM} range *	50 to 1000	V
T_J	- 40 to 200	°C

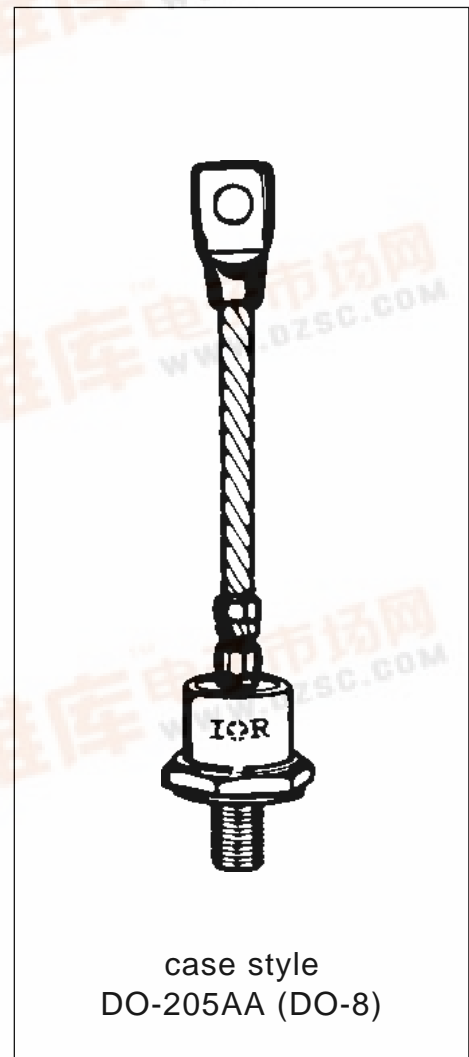

* 45L available from 100V to 1000V

ELECTRICAL SPECIFICATIONS

Voltage Ratings

Type number**	Voltage Code	V_{RRM} , maximum repetitive peak reverse voltage V	V_{RSM} , maximum non-repetitive peak rev. voltage V	I_{RRM} max. @ $T_J = 175^\circ\text{C}$ mA
45L(R) * 150K(R) 150L(R) 150KS(R)	5	50	100	35
	10	100	200	35
	20	200	300	35
	30	300	400	35
	40	400	500	35
	60	600	720	35
	80	800	960	32
	100	1000	1200	24

* 45L 50V and 300V V_{RRM} classes are not available.

**Also available as JEDEC series 1N3288A through 1N3296A (DO-8 case style) and 1N3111 through 1N3092 (DO-30 case style)

Forward Conduction

Parameter	45L/150...	Units	Conditions
$I_{F(AV)}$ Max. average forward current @ Case temperature	150	A	180° conduction, half sine wave
	150	°C	
$I_{F(RMS)}$ Max. RMS forward current	235	A	DC @ 142°C case temperature
I_{FSM} Max. peak, one-cycle forward, non-repetitive surge current	3570	A	t = 10ms No voltage
	3740		t = 8.3ms reapplied
	3000		t = 10ms 100% V_{RRM}
	3140		t = 8.3ms reapplied
I^2t Maximum I^2t for fusing	64	KA ² s	t = 10ms No voltage
	58		t = 8.3ms reapplied
	45		t = 10ms 100% V_{RRM}
	41		t = 8.3ms reapplied
$I^2\sqrt{t}$ Maximum $I^2\sqrt{t}$ for fusing	640	KA ² /s	t = 0.1 to 10ms, no voltage reapplied
$V_{F(TO)1}$ Low level value of threshold voltage	0.67	V	(16.7% $\times \pi \times I_{F(AV)} < I < \pi \times I_{F(AV)}$), $T_J = T_J$ max.
$V_{F(TO)2}$ High level value of threshold voltage	0.83		($I > \pi \times I_{F(AV)}$), $T_J = T_J$ max.
r_{f1} Low level value of forward slope resistance	1.42	mΩ	(16.7% $\times \pi \times I_{F(AV)} < I < \pi \times I_{F(AV)}$), $T_J = T_J$ max.
r_{f2} High level value of forward slope resistance	0.91		($I > \pi \times I_{F(AV)}$), $T_J = T_J$ max.
V_{FM} Max. forward voltage drop	1.33	V	$I_{pk} = 471\text{A}$, $T_J = 25^\circ\text{C}$, $t_p = 10\text{ms}$ sinusoidal wave

查询"150K(R)SERIES"供应商

Thermal and Mechanical Specifications

Parameter	45L/150...	Units	Conditions	
T _J Max. junction operating temperature	-40 to 200	°C		
T _{stg} Max. storage temperature range	-40 to 200			
R _{thJC} Max. thermal resistance, junction to case	0.25	K/W	DC operation	
R _{thCS} Max. thermal resistance, case to heatsink	0.10		Mounting surface, smooth, flat and greased	
T Mounting torque	Min.	14.1 (125)	Nm (lbf-in)	
	45L Max.	17.0 (150)		Not lubricated threads
	150L Min.	12.2 (108)		Lubricated threads
	Max.	15.0 (132)		
	150K Min.	11.3 (100)	Nm (lbf-in)	Not lubricated threads
	150KS Max.	14.1 (125)		
	Min.	9.5 (85)		Lubricated threads
	Max.	12.5 (110)		
wt Approximate weight	100 (3.5)	g (oz)		
Case style	150K-A	DO205AA (DO-8)	See Outline Table	
	150KS	B-42		
	150L-A/45L	DO-205AC (DO-30)		

ΔR_{thJC} Conduction

(The following table shows the increment of thermal resistance R_{thJC} when devices operate at different conduction angles than DC)

Conduction angle	Sinusoidal conduction	Rectangular conduction	Units	Conditions
180°	0.031	0.023	K/W	T _J = T _J max.
120°	0.038	0.040		
90°	0.048	0.053		
60°	0.071	0.075		
30°	0.120	0.121		

Ordering Information Table

Device Code

45	L	F	R	100
①	②	③	④	⑤

- 1** - 45 = Standard version
47 = Version with Pinch Bolt (only flat base; available on request)
- 2** - L = Essential Part Number
- 3** - F = Flat Base
None = Normal Stud 1/2" - 20UNF -2A
- 4** - R = Stud Reverse Polarity (Anode to Stud)
None = Stud Normal Polarity (Cathode to Stud)
- 5** - Voltage code: Code x 10 = V_{RRM} (See Voltage Ratings table)
NOTE: For longer lead Contact Factory

Device Code

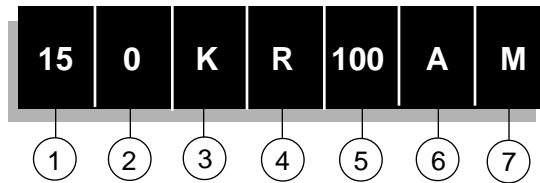

- 1** - Average Forward Current: Code x 10 = I_{FAV}
- 2** - 0 = Standard Case
2 = Stud Topped Case (152K-A only)
- 3** - Case Style
K = DO205AA (DO-8)
KS = B-42
L = DO205AC (DO-30)
- 4** - R = Stud Reverse Polarity (Anode to Stud)
None = Stud Normal Polarity (Cathode to Stud)
- 5** - Voltage code: Code x 10 = V_{RRM} (See Voltage Ratings table)
- 6** - A = Essential Part Number for 150K and 150L (Omitted for 150KS)
- 7** - None = Standard Base
M = Metric Base M12 x 1.5

NOTE: For longer lead Contact Factory

All dimensions in millimeters (inches)

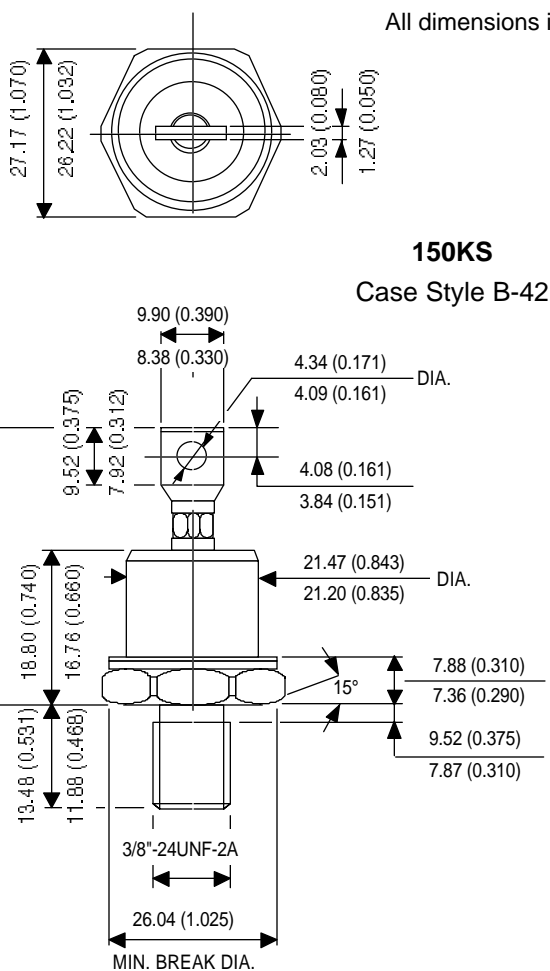

152K-A
IR Case Style B-28

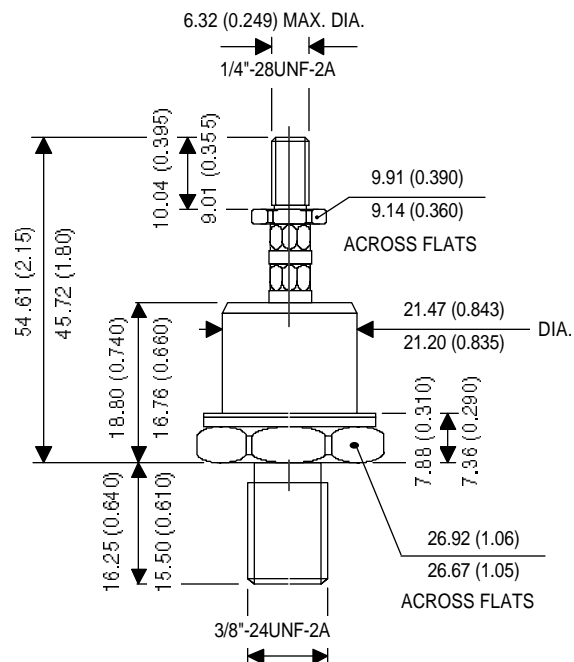

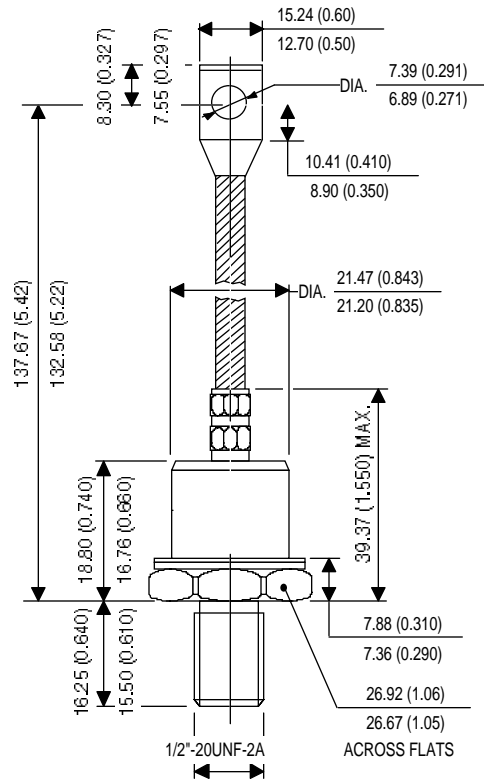

45L
Case Style

All dimensions in millimeters (inches)

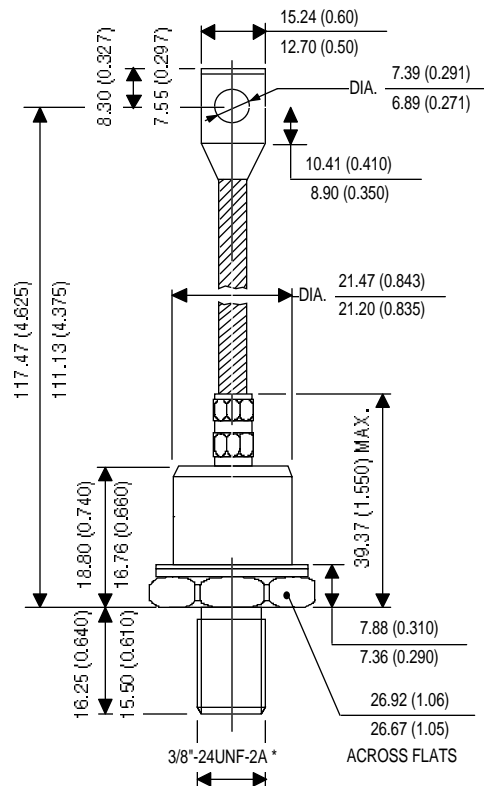

150K
Case Style

* FOR METRIC DEVICE M12 X 1.5

Outline Table

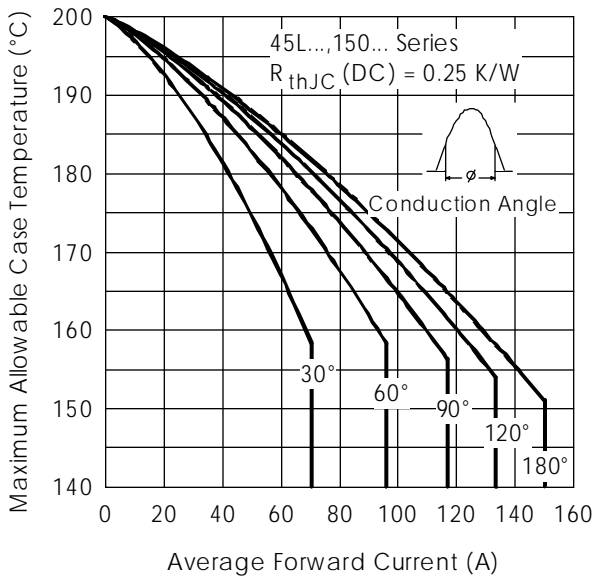
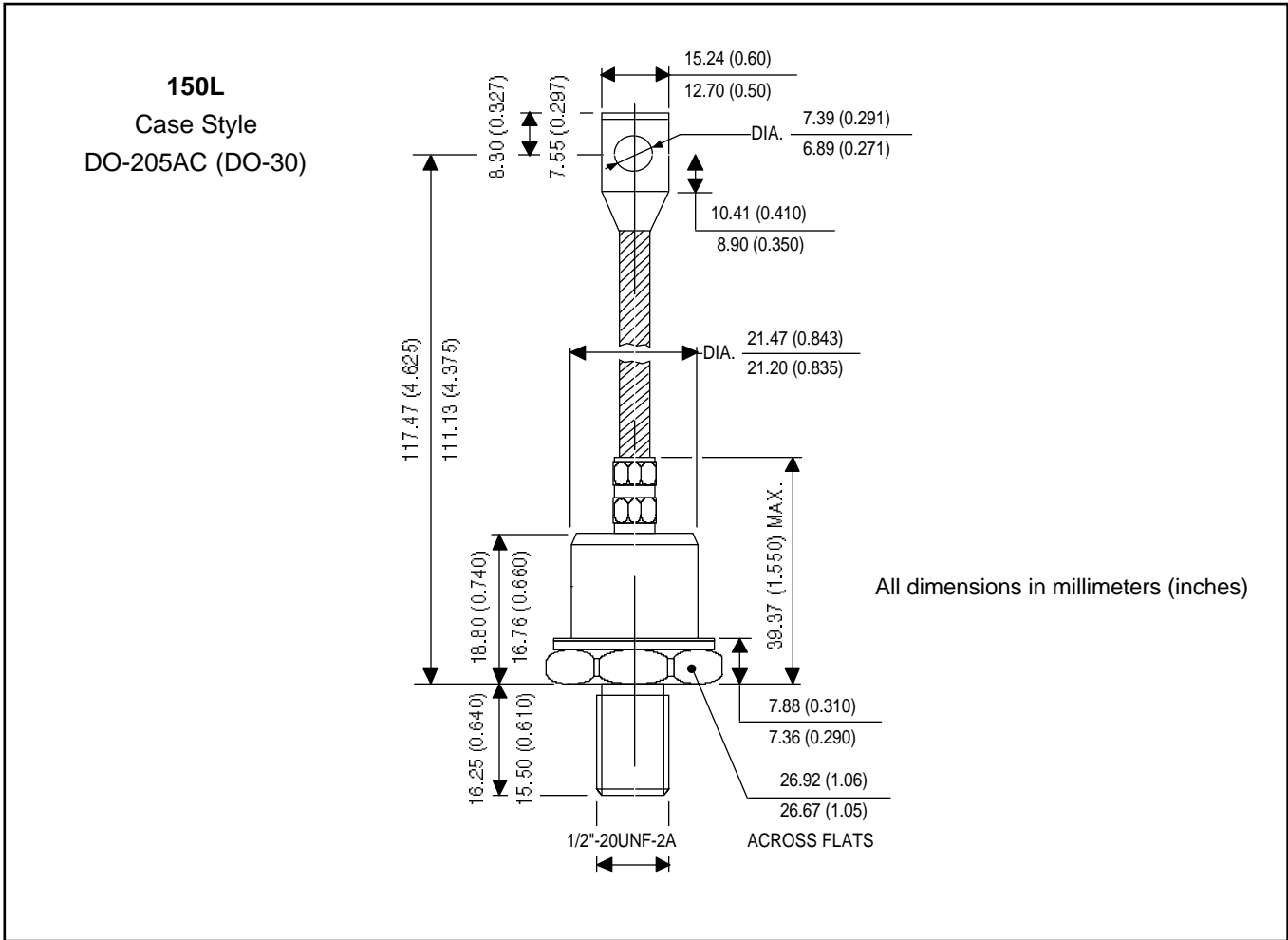

Fig. 1 - Current Ratings Characteristics

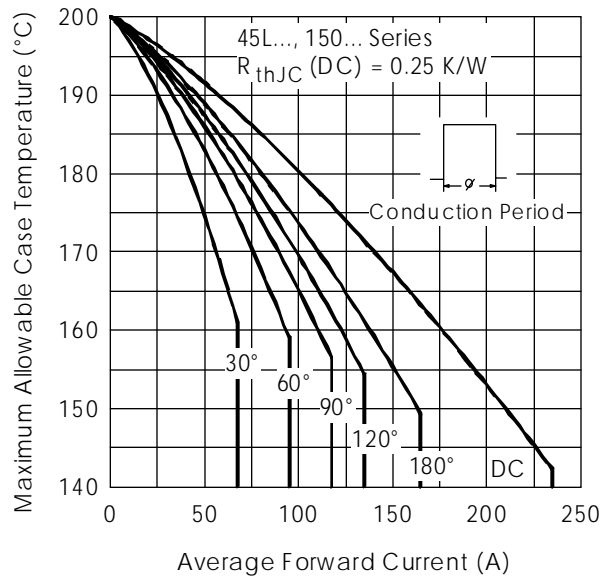

Fig. 2 - Current Ratings Characteristics

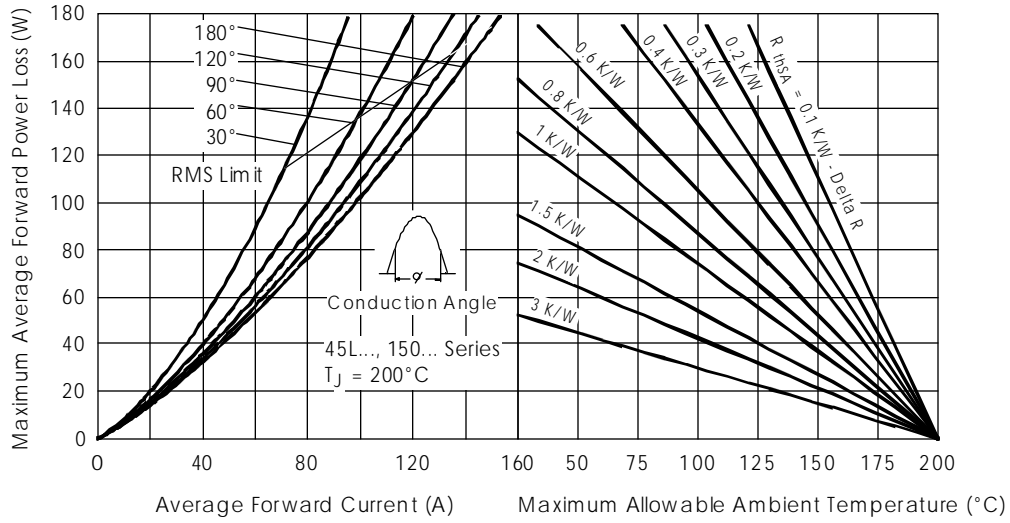

Fig. 3 - Forward Power Loss Characteristics

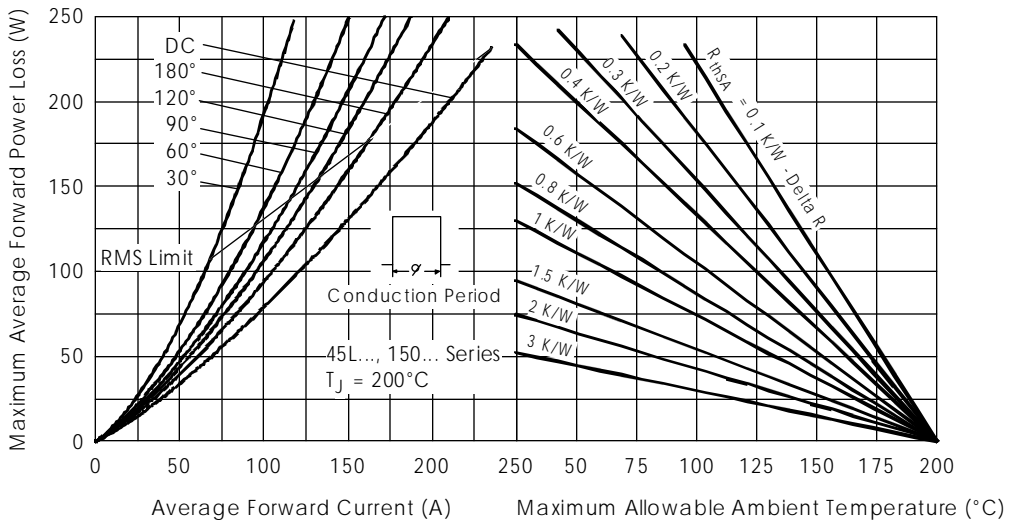

Fig. 4 - Forward Power Loss Characteristics

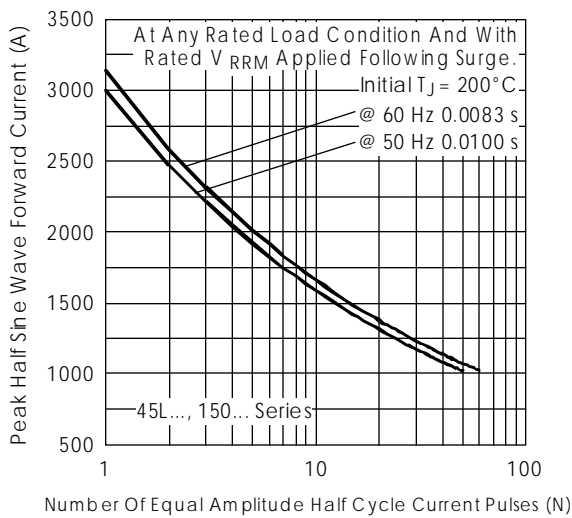

Fig. 5 - Maximum Non-Repetitive Surge Current

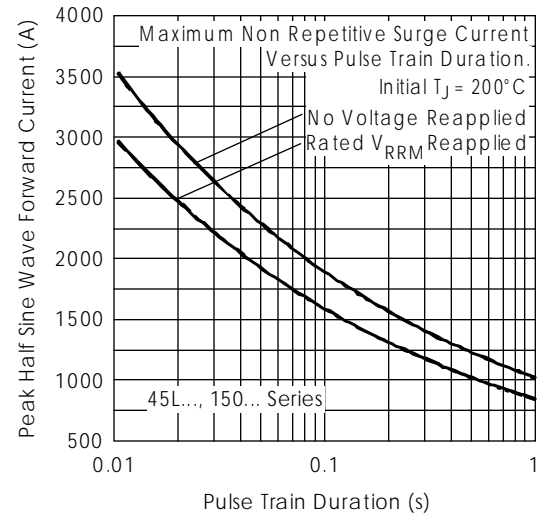

Fig. 6 - Maximum Non-Repetitive Surge Current

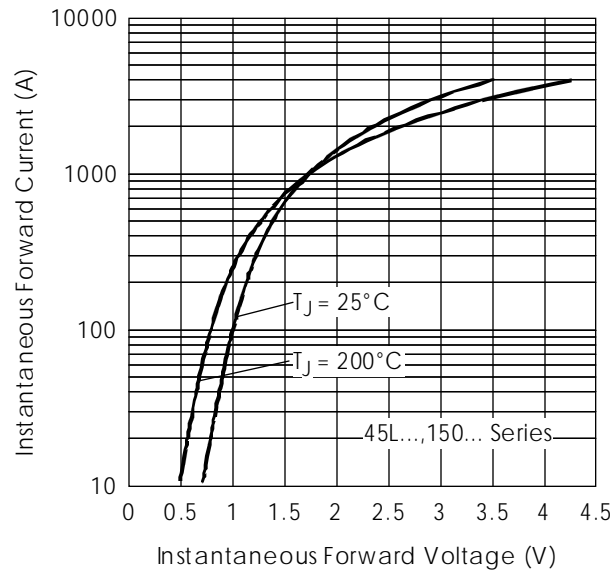

Fig. 7 - Forward Voltage Drop Characteristics

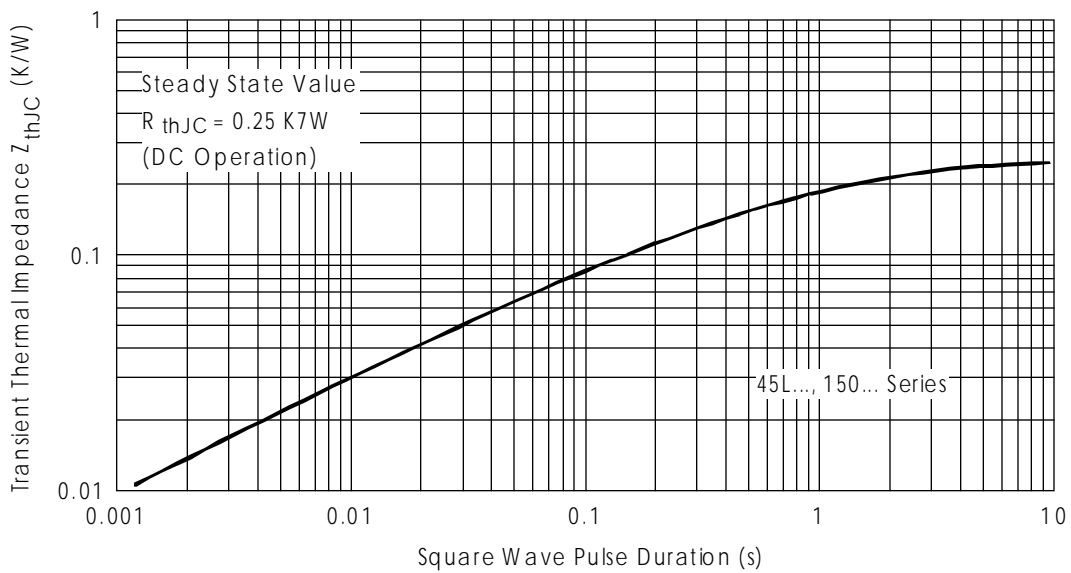

Fig. 8 - Thermal Impedance Z_{thJC} Characteristic