

ENERGIZER NO. 1215

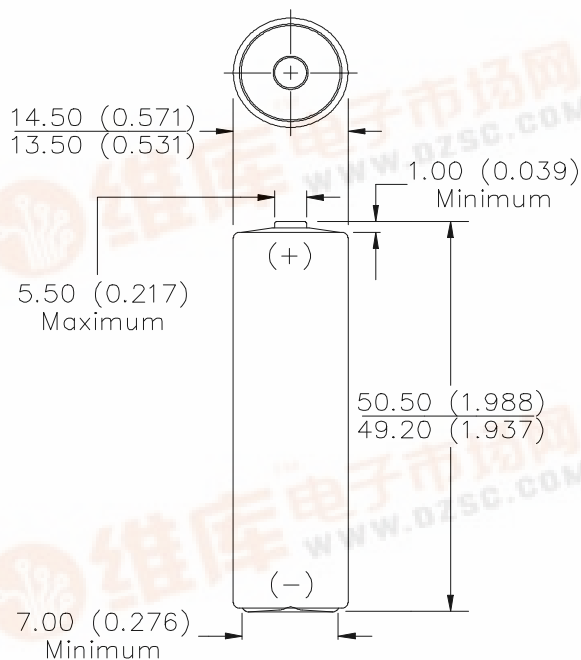

Industry Standard Dimensions in mm (inches)



AA

SUPER HEAVY DUTY

Chemical System: Zinc-Manganese Dioxide (Zn/MnO₂)
(No Added Mercury or Cadmium)

Designation: ANSI-15D, IEC-R6

Battery Voltage: 1.5 Volts

Operating Temp: -18°C to 55°C (0°F to 130°F)

Average Weight: 15.0 grams (0.5 oz.)

Volume: 8.0 cubic centimeters (0.5 cubic inch)

Average Capacity: 1,100 mAh to 0.8 volts
(Rated capacity at 25 mA continuous at 21°C)

Cell: One No. 15 (size "AA")

Jacket: Metal

INTERNAL RESISTANCE VS. TEMPERATURE

The measurement is an approximation of the battery's actual internal resistance. It is sensitive to the loads and operator technique.

Schedule: Background Load 750 ohms
 Pulse Load 4.0 ohms
 Pulse Duration 1 second

Temperature	Typical Ri (ohms)
45°C (113°F)	0.4
21°C (70°F)	0.5
0°C (32°F)	0.8
-21°C (-4°F)	5.0

CONSTANT RESISTANCE PERFORMANCE
Typical Service

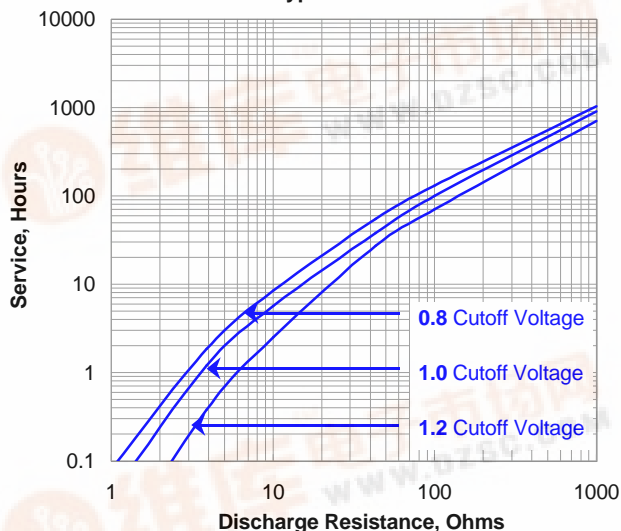

CONSTANT CURRENT DISCHARGE
Typical Service

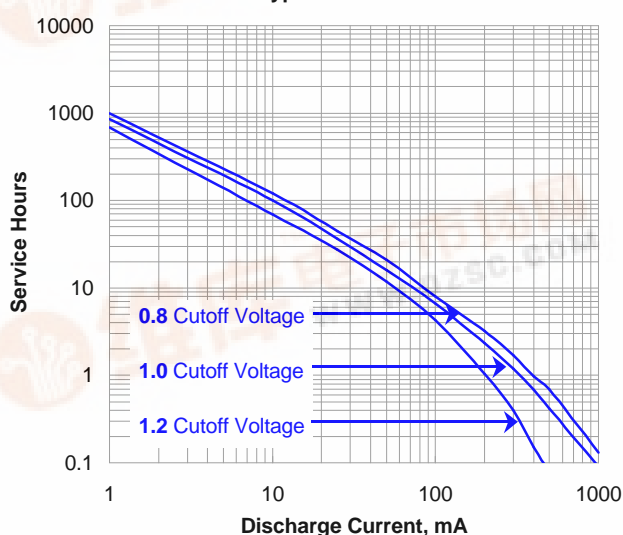

Important Notice

This data sheet contains information specific to batteries manufactured at the time of its publication.

Contents herein do not constitute a warranty.

Copyright © Eveready Battery Co. - All rights reserved

ENERGIZER NO. 1215

ANSI Industry Standard Tests @ 20° C

RADIO
43 ohm - 4 hours/day

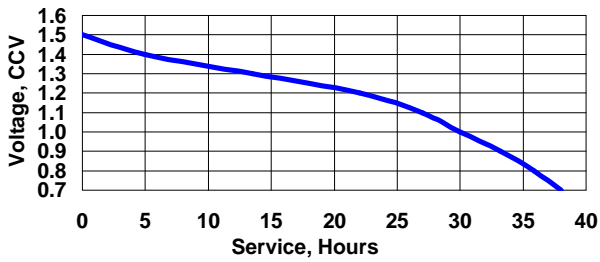

RECORDER
10 ohm - 1 hr/day

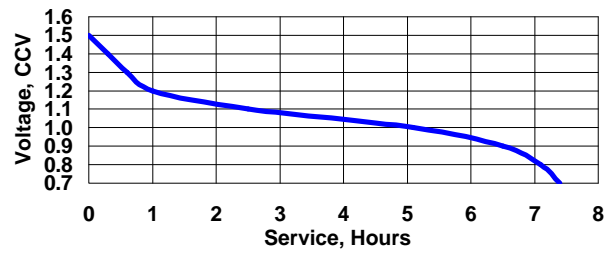

TOY
3.9 ohm - 1 hr/day

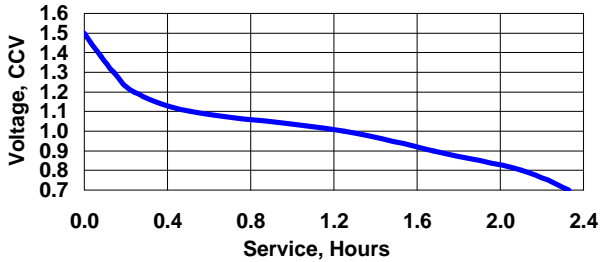

PULSE TEST
1.8 ohms - 15sec/min 24 hours/day

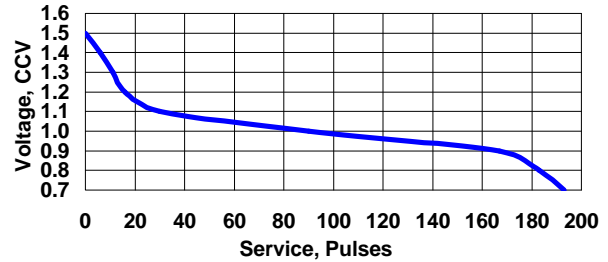

Important Notice

This data sheet contains information specific to batteries manufactured at the time of its publication.

Contents herein do not constitute a warranty.

Copyright © Eveready Battery Co. - All rights reserved