

Series 4445R
4445
 查询"4445R-20K"供应商
Radial Toroidal Inductors

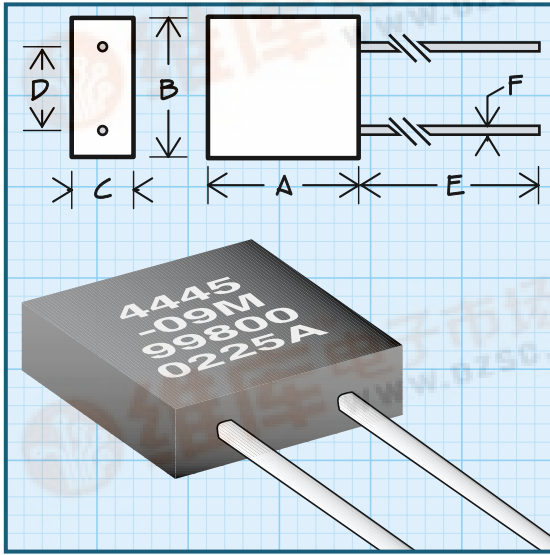

Military Specification MS-21423 (ref.)

Mechanical Configuration Units are radial leaded and encapsulated in an epoxy molded package.

Physical Parameters

	Inches	Millimeters
A	0.200 to 0.230	5.08 to 5.84
B	0.190 to 0.210	4.83 to 5.33
C	0.090 to 0.110	2.29 to 2.79
D	0.090 to 0.110	2.29 to 2.79
E	1.00 Min.	25.4 Min.
F	0.0185 to 0.0215	0.470 to 0.546

Operating Temperature -55°C to +125°C

Current Rating at 90°C Ambient 35°C Rise

Maximum Power Dissipation at 90°C 0.200 W

Note Inductance measured 0.25" from body.

Weight Max. (Grams) 0.5

Packaging Bulk only

Made in the U.S.A.

****Note:** Self Resonant Frequency (SRF) values above 250 MHz are calculated and for reference only.

DASH NUMBER*
 MIL DASH # (Ref.)
 INDUCTANCE (µH)
 TOLERANCE
 Q MINIMUM
 TEST FREQUENCY (MHz)
 SRF MINIMUM (MHz)**
 DC RESISTANCE MAXIMUM (OHMS)
 CURRENT RATING MAXIMUM (mA)

MS21423 (Ref.) - SERIES 4445								
-01M	1	0.010	± 20%	60	150	1000	0.020	3000
-02M	2	0.012	± 20%	60	150	1000	0.020	3000
-03M	3	0.015	± 20%	60	150	1000	0.020	3000
-04M	4	0.018	± 20%	60	150	1000	0.020	3000
-05M	5	0.022	± 20%	60	100	900	0.020	3000
-06M	6	0.027	± 20%	60	100	800	0.020	3000
-07M	7	0.033	± 20%	60	100	750	0.020	3000
-08M	8	0.039	± 20%	60	100	700	0.020	3000
-09M	9	0.047	± 20%	60	100	650	0.020	3000
-10M	10	0.056	± 20%	60	100	600	0.020	3000
-11M	11	0.068	± 20%	60	100	550	0.030	2500
-12M	12	0.082	± 20%	60	100	500	0.040	2200
-13K	13	0.100	± 10%	80	50	450	0.040	2200
-14K	14	0.120	± 10%	80	50	400	0.050	2000
-15K	15	0.150	± 10%	80	50	350	0.060	1800
-16K	16	0.180	± 10%	80	50	320	0.070	1600
-17K	17	0.220	± 10%	80	50	300	0.080	1500
-18K	18	0.270	± 10%	80	50	280	0.100	1400
-19K	19	0.330	± 10%	80	50	260	0.120	1300
-20K	20	0.390	± 10%	80	50	240	0.150	1150
-21K	21	0.470	± 10%	80	50	220	0.200	1000
-22K	22	0.560	± 10%	70	50	200	0.250	900
-23K	23	0.680	± 10%	70	50	180	0.300	800
-24K	24	0.820	± 10%	70	50	160	0.350	750
-25K	25	1.000	± 10%	70	50	150	0.400	700

Optional Tolerances: J = 5% H = 3% G = 2%
 (Dash 01-12 Min. Tolerance is ±5%)

*Complete part # must include series # PLUS the dash #

For further surface finish information, refer to TECHNICAL section of this catalog.

