



October 1989
Revised November 1999

100352

Low Power 8-Bit Buffer with Cut-Off Drivers

General Description

The 100352 contains an 8-bit buffer, individual inputs (D_n), outputs (Q_n), and a data output enable pin (\overline{OEN}). A Q output follows its D input when the \overline{OEN} pin is LOW. A HIGH on \overline{OEN} holds the outputs in a cut-off state. The cut-off state is designed to be more negative than a normal ECL LOW level. This allows the output emitter-followers to turn off when the termination supply is $-2.0V$, presenting a high impedance to the data bus. This high impedance reduces termination power and prevents loss of low state noise margin when several loads share the bus.

The 100352 outputs are designed to drive a doubly terminated 50Ω transmission line (25Ω load impedance). All inputs have $50\text{ k}\Omega$ pull-down resistors.

Features

- Cut-off drivers
- Drives 25Ω load
- Low power operation
- 2000V ESD protection
- Voltage compensated operating range = $-4.2V$ to $-5.7V$
- Available to industrial grade temperature range

Ordering Code:

Order Number	Package Number	Package Description
100352PC	N24E	24-Lead Plastic Dual-In-Line Package (PDIP), JEDEC MS-011, 0.400 Wide
100352QC	V28A	28-Lead Plastic Lead Chip Carrier (PLCC), JEDEC MO-047, 0.450 Square
100352QI	V28A	28-Lead Plastic Lead Chip Carrier (PLCC), JEDEC MO-047, 0.450 Square Industrial Temperature Range (-40°C to $+85^\circ\text{C}$)

Devices also available in Tape and Reel. Specify by appending the suffix letter "X" to the ordering code.

Logic Symbol

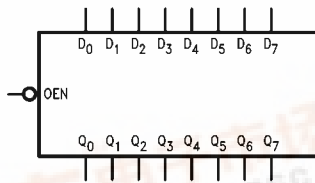

Connection Diagrams

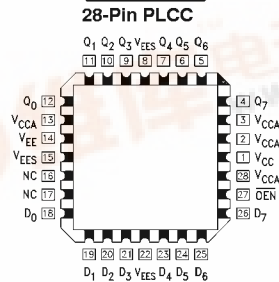
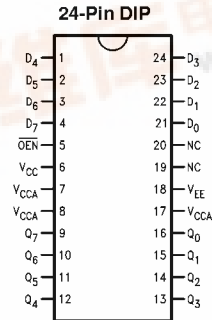

Pin Descriptions

Pin Names	Description
D_0 - D_7	Data Inputs
\overline{OEN}	Output Enable Input
Q_0 - Q_7	Data Outputs
NC	No Connect



100352

Truth Table

Inputs		Outputs
D_n	\overline{OEN}	Q_n
L	L	L
H	L	H
X	H	Cutoff

H = HIGH Voltage Level
L = LOW Voltage Level
Cutoff = Lower-than-LOW State
X = Don't Care

Logic Diagram

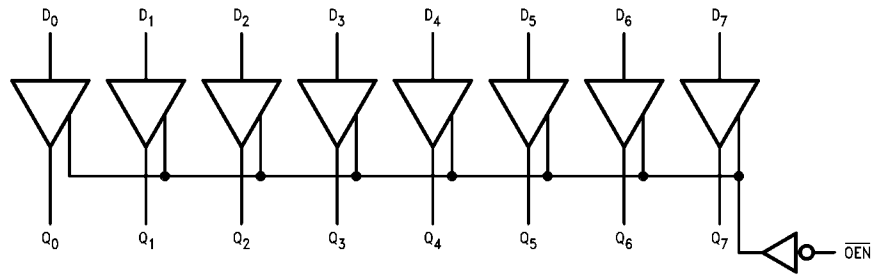

Absolute Maximum Ratings (Note 1)				Recommended Operating Conditions					
Storage Temperature (T _{STG})	-65°C to +150°C			Case Temperature (T _C)	Commercial 0°C to +85°C				
Maximum Junction Temperature (T _J)	+150°C			Industrial	-40°C to +85°C				
V _{EE} Pin Potential to Ground Pin	-7.0V to +0.5V			Supply Voltage (V _{EE})	-5.7V to -4.2V				
Input Voltage (DC)	V _{EE} to +0.5V			Note 1: The "Absolute Maximum Ratings" are those values beyond which the safety of the device cannot be guaranteed. The device should not be operated at these limits. The parametric values defined in the Electrical Characteristics tables are not guaranteed at the absolute maximum rating. The "Recommended Operating Conditions" table will define the conditions for actual device operation.					
Output Current (DC Output HIGH)	-100 mA			Note 2: ESD testing conforms to MIL-STD-883, Method 3015.					
ESD (Note 2)	≥2000V								
Commercial Version									
DC Electrical Characteristics (Note 3)									
V _{EE} = -4.2V to -5.7V, V _{CC} = V _{CCA} = GND, T _C = 0°C to +85°C									
Symbol	Parameter	Min	Typ	Max	Units	Conditions			
V _{OH}	Output HIGH Voltage	-1025	-955	-870	mV	V _{IN} = V _{IH} (Max) or V _{IL} (Min)	Loading with 25Ω to -2.0V		
V _{OL}	Output LOW Voltage	-1830	-1705	-1620					
V _{OHc}	Output HIGH Voltage	-1035			mV	V _{IN} = V _{IH} (Min) or V _{IL} (Max)	Loading with 25Ω to -2.0V		
V _{OLc}	Output LOW Voltage			-1610					
V _{OLZ}	Cut-Off LOW Voltage			-1950	mV	V _{IN} = V _{IH} (Min) or V _{IL} (Max)	OEN = HIGH		
V _{IH}	Input HIGH Voltage	-1165		-870	mV	Guaranteed HIGH Signal for All Inputs			
V _{IL}	Input LOW Voltage	-1830		-1475	mV	Guaranteed LOW Signal for All Inputs			
I _{IL}	Input LOW Current	0.50			μA	V _{IN} = V _{IL} (Min)			
I _{IH}	Input HIGH Current			240	μA	V _{IN} = V _{IH} (Max)			
I _{EE}	Power Supply Current	-138		-70	mA	Inputs Open			
		-143		-70		V _{EE} = -4.2V to -4.8V V _{EE} = -4.2V to -5.7V			
Note 3: The specified limits represent the "worst case" value for the parameter. Since these values normally occur at the temperature extremes, additional noise immunity and guardbanding can be achieved by decreasing the allowable system operating ranges. Conditions for testing shown in the tables are chosen to guarantee operation under "worst case" conditions.									
DIP AC Electrical Characteristics									
V _{EE} = -4.2V to -5.7V, V _{CC} = V _{CCA} = GND									
Symbol	Parameter	T _C = 0°C		T _C = +25°C		T _C = +85°C		Units	Conditions
		Min	Max	Min	Max	Min	Max		
t _{PLH}	Propagation Delay	0.70	2.00	0.70	2.00	0.70	2.20	ns	Figures 1, 2 (Note 4)
t _{PHL}	Dn to Output								
t _{PZH}	Propagation Delay	1.60	4.20	1.60	4.20	1.60	4.20	ns	Figures 1, 2 (Note 4)
t _{PHZ}	OEN to Output								
t _{TLH}	Transition Time	0.45	2.00	0.45	2.00	0.45	2.00	ns	Figures 1, 2
t _{THL}	20% to 80%, 80% to 20%								
Note 4: The propagation delay specified is for single output switching. Delays may vary up to 300 ps with multiple outputs switching.									

100352

Commercial Version (Continued)									
PLCC AC Electrical Characteristics									
$V_{EE} = 4.2V$ to $-5.7V$, $V_{CC} = V_{CCA} = GND$									
Symbol	Parameter	$T_C = 0^\circ C$		$T_C = +25^\circ C$		$T_C = +85^\circ C$		Units	Conditions
		Min	Max	Min	Max	Min	Max		
t_{PLH}	Propagation Delay	0.70	1.80	0.70	1.80	0.70	2.00	ns	Figures 1, 2
t_{PHL}	Dn to Output								(Note 5)
t_{PZH}	Propagation Delay	1.60	4.00	1.60	4.00	1.60	4.00	ns	Figures 1, 2
t_{PHZ}	OEN to Output	1.00	2.50	1.00	2.50	1.00	2.50		(Note 5)
t_{TLH}	Transition Time	0.45	1.90	0.45	1.90	0.45	1.90	ns	Figures 1, 2
t_{THL}	20% to 80%, 80% to 20%								
t_{OSHL}	Maximum Skew Common Edge Output-to-Output Variation Data to Output Path		230		230		230	ps	PLCC only (Note 6)
t_{OSLH}	Maximum Skew Common Edge Output-to-Output Variation Data to Output Path		240		240		240	ps	PLCC only (Note 6)
t_{OST}	Maximum Skew Opposite Edge Output-to-Output Variation Data to Output Path		350		350		350	ps	PLCC only (Note 6)
t_{PS}	Maximum Skew Pin (Signal) Transition Variation Data to Output Path		350		350		350	ps	PLCC only (Note 6)

Note 5: The propagation delay specified is for single output switching. Delays may vary up to 300 ps with multiple outputs switching.

Note 6: Output-to-Output Skew is defined as the absolute value of the difference between the actual propagation delay for any outputs within the same packaged device. The specifications apply to any outputs switching in the same direction either HIGH-to-LOW (t_{OSHL}), or LOW-to-HIGH (t_{OSLH}), or in opposite directions both HL and LH (t_{OST}). Parameters t_{OST} and t_{PS} guaranteed by design.

Industrial Version									
PLCC DC Electrical Characteristics (Note 7)									
$V_{EE} = -4.2V$ to $-5.7V$, $V_{CC} = V_{CCA} = GND$, $T_C = -40^{\circ}C$ to $+85^{\circ}C$									
Symbol	Parameter	$T_C = -40^{\circ}C$		$T_C = 0^{\circ}C$ to $+85^{\circ}C$		Units	Conditions		
		Min	Max	Min	Max				
V_{OH}	Output HIGH Voltage	-1085	-870	-1025	-870	mV	$V_{IN} = V_{IH(Max)}$ or $V_{IL(Min)}$	Loading with 25Ω to $-2.0V$	
V_{OL}	Output LOW Voltage	-1830	-1575	-1830	-1620				
V_{OHC}	Output HIGH Voltage	-1095		-1035		mV	$V_{IN} = V_{IH(Min)}$ or $V_{IL(Max)}$	Loading with 25Ω to $-2.0V$	
V_{OLC}	Output LOW Voltage		-1565		-1610				
V_{OLZ}	Cut-Off LOW Voltage		-1950		-1950	mV	$V_{IN} = V_{IH(Min)}$ or $V_{IL (Max)}$	OEN = HIGH	
V_{IH}	Input HIGH Voltage	-1170	-870	-1165	-870	mV	Guaranteed HIGH Signal for All Inputs		
V_{IL}	Input LOW Voltage	-1830	-1480	-1830	-1475	mV	Guaranteed LOW Signal for All Inputs		
I_{IL}	Input LOW Current	0.50		0.50		μA	$V_{IN} = V_{IL(Min)}$		
I_{IH}	Input HIGH Current		340		240	μA	$V_{IN} = V_{IH(Max)}$		
I_{EE}	Power Supply Current					mA	Inputs OPEN		
		-138	-60	-138	-70		$V_{EE} = -4.2V$ to $-4.8V$ $V_{EE} = -4.2V$ to $-5.7V$		
<p>Note 7: The specified limits represent the "worst case" value for the parameter. Since these values normally occur at the temperature extremes, additional noise immunity and guardbanding can be achieved by decreasing the allowable system operating ranges. Conditions for testing shown in the tables are chosen to guarantee operation under "worst case" conditions.</p>									
PLCC AC Electrical Characteristics									
$V_{EE} = 4.2V$ to $-5.7V$, $V_{CC} = V_{CCA} = GND$									
Symbol	Parameter	$T_C = -40^{\circ}C$		$T_C = +25^{\circ}C$		$T_C = +85^{\circ}C$		Units	Conditions
		Min	Max	Min	Max	Min	Max		
t_{PLH}	Propagation Delay							ns	Figures 1, 2 (Note 8)
t_{PHL}	Dn to Output	0.60	1.80	0.70	1.80	0.70	2.00		
t_{PZH}	Propagation Delay	1.40	4.40	1.60	4.00	1.60	4.00	ns	Figures 1, 2 (Note 8)
t_{PHZ}	OEN to Output	1.00	2.50	1.00	2.50	1.00	2.50		
t_{TLH}	Transition Time	0.40	2.50	0.45	1.90	0.45	1.90	ns	Figures 1Figure 2
t_{THL}	20% to 80%, 80% to 20%								
<p>Note 8: The propagation delay specified is for single output switching. Delays may vary up to 300 ps with multiple outputs switching.</p>									

100352

Test Circuitry

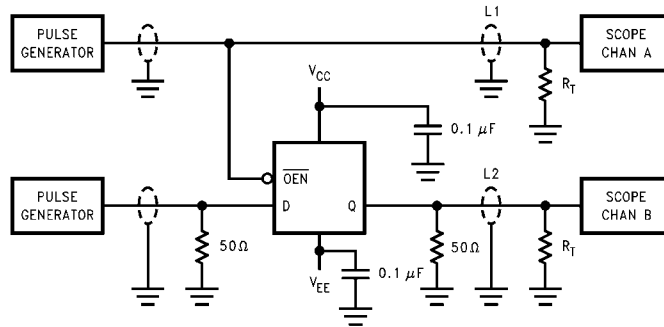

Notes:

- $V_{CC}, V_{CCA} = +2V, V_{EE} = -2.5V$
- L1 and L2 = equal length 50Ω impedance lines
- $R_T = 50\Omega$ terminator internal to scope
- Decoupling 0.1 μF from GND to V_{CC} and V_{EE}
- All unused outputs are loaded with 25Ω to GND
- C_L = Fixture and stray capacitance ≤ 3 pF

FIGURE 1. AC Test Circuit

Switching Waveforms

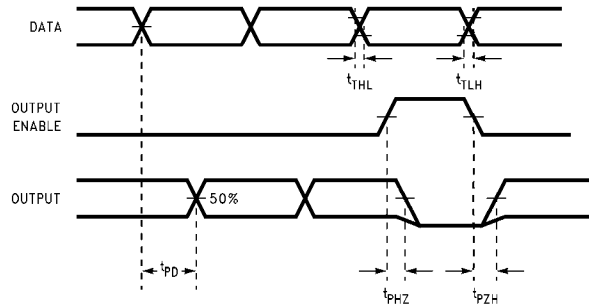

Note:

The output AC measurement point for cut-off propagation delay testing is the 50% voltage point between active V_{OL} and V_{OH} .

FIGURE 2. Propagation Delay, Cut-Off and Transition Times

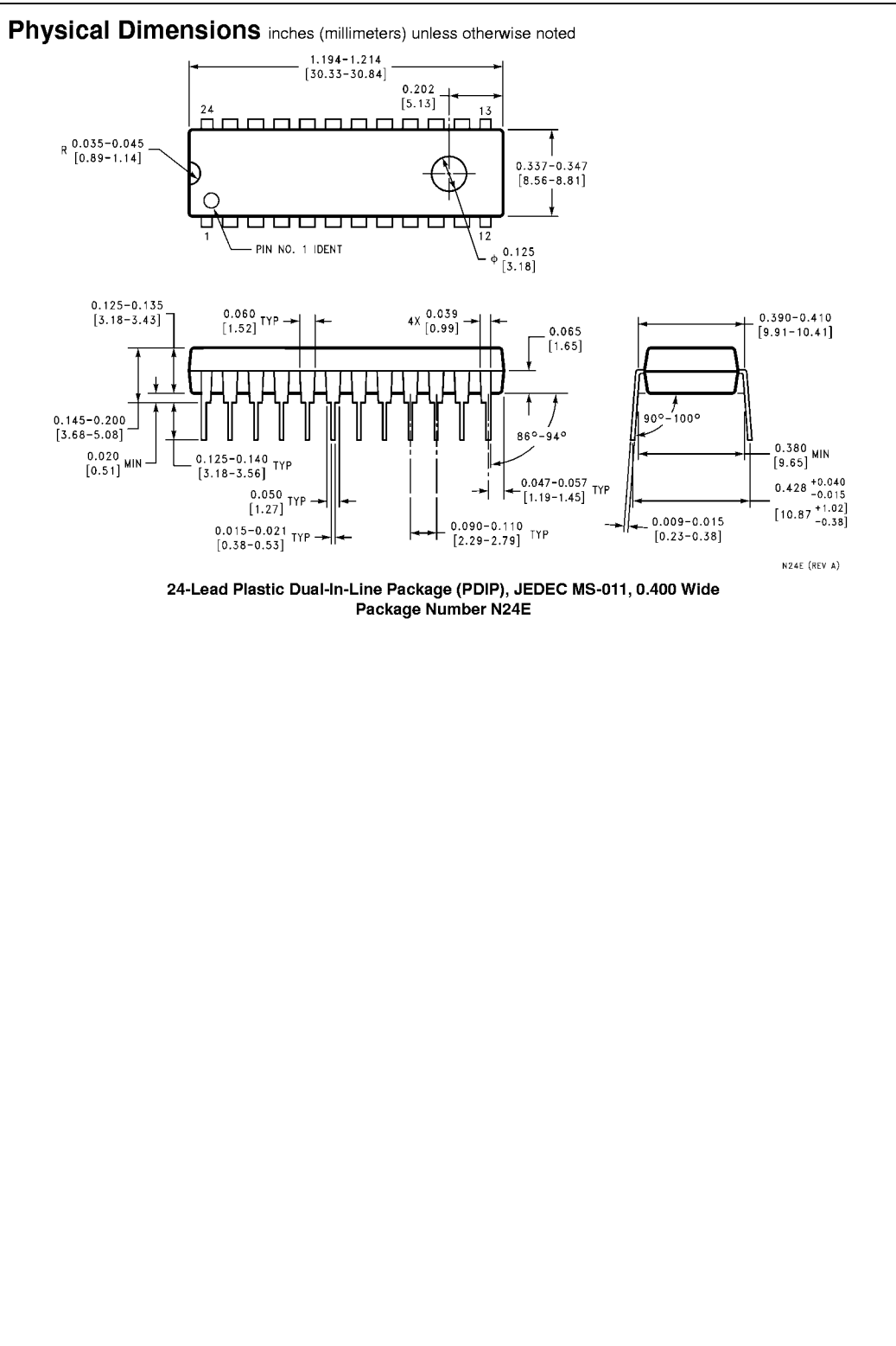

Physical Dimensions inches (millimeters) unless otherwise noted (Continued)

0.450 $\begin{matrix} +0.006 \\ -0.000 \end{matrix}$
[11.43]

PIN #1 IDENT

0.029 \pm 0.003 TYP
[0.74 \pm 0.08]

45° X 0.045 [1.14]

0.017 \pm 0.004 TYP
[0.43 \pm 0.10]

0.410 \pm 0.020 TYP
[10.41 \pm 0.51]

SEATING PLANE

0.020 MIN TYP
[0.51]

0.105 \pm 0.015 TYP
[2.67 \pm 0.38]

0.004 [0.10]

0.050 TYP
[1.27]

0.300 TYP
[7.62]

45° X 0.045 [1.14]

0.165-0.180 TYP
[4.19-4.57]

0.490 \pm 0.005 TYP
[12.45 \pm 0.13]

V28A (REV. K)

28-Lead Plastic Lead Chip Carrier (PLCC), JEDEC MO-047, 0.450 Square Package Number V28A

Fairchild does not assume any responsibility for use of any circuitry described, no circuit patent licenses are implied and Fairchild reserves the right at any time without notice to change said circuitry and specifications.

LIFE SUPPORT POLICY

FAIRCHILD'S PRODUCTS ARE NOT AUTHORIZED FOR USE AS CRITICAL COMPONENTS IN LIFE SUPPORT DEVICES OR SYSTEMS WITHOUT THE EXPRESS WRITTEN APPROVAL OF THE PRESIDENT OF FAIRCHILD SEMICONDUCTOR CORPORATION. As used herein:

1. Life support devices or systems are devices or systems which, (a) are intended for surgical implant into the body, or (b) support or sustain life, and (c) whose failure to perform when properly used in accordance with instructions for use provided in the labeling, can be reasonably expected to result in a significant injury to the user.
2. A critical component in any component of a life support device or system whose failure to perform can be reasonably expected to cause the failure of the life support device or system, or to affect its safety or effectiveness.

www.fairchildsemi.com