

# XBS013R1DR-G

查询XBS013R1DR-G供应商

ETR1617-005

Schottky Barrier Diode, 100mA, 30V Type

## FEATURES

Ultra Small Package  
Low IR

## APPLICATIONS

Low Current Rectification

## ABSOLUTE MAXIMUM RATINGS

Ta=25

PARAMETER	SYMBOL	RATINGS	UNITS
Repetitive Peak Voltage	V <sub>RM</sub>	30	V
Reverse Voltage (DC)	V <sub>R</sub>	30	V
Forward Current (Average)	I <sub>F(AV)</sub>	100	mA
Peak Forward Surge Current <sup>*1)</sup>	I <sub>FSM</sub>	0.5	A
Junction Temperature	T <sub>j</sub>	150	
Storage Temperature Range	T <sub>stg</sub>	-40 ~ +150	

\*1) 60Hz Half sine wave, 1 cycle, Non-Repetitive.

## PACKAGING INFORMATION

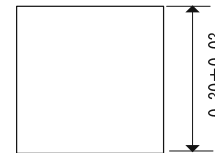
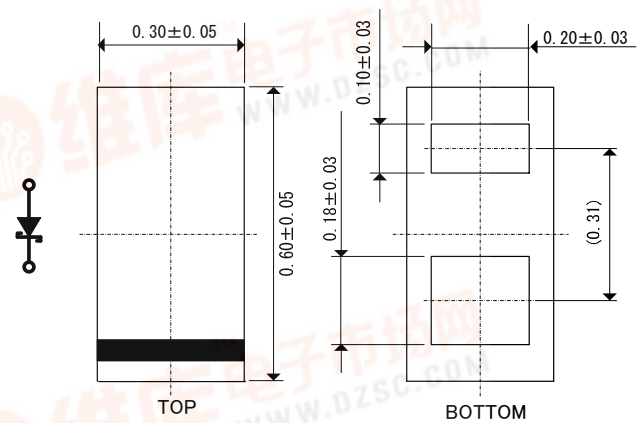

Unit: mm

## MARKING RULE

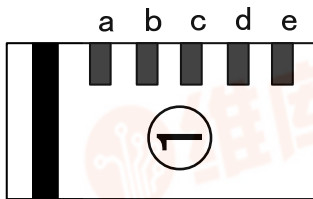

: 2 (Product Number)  
a,b,c,d,e : Lot Number

## PRODUCT NAME

PRODUCT NAME	PACKAGE
XBS013R1DR-G	USP-2B01

\* The "-G" suffix indicates that the products are Halogen and Antimony free as well as being fully RoHS compliant.

\* The device orientation is fixed in its embossed tape pocket.

## ELECTRICAL CHARACTERISTICS

Ta=25

PARAMETER	SYMBOL	TEST CONDITIONS	LIMITS			UNITS
			MIN.	TYP.	MAX.	
Forward Voltage	V <sub>F1</sub>	I <sub>F</sub> =10mA	-	-	0.46	V
Reverse Current	I <sub>R</sub>	V <sub>R</sub> =10V	-	-	0.3	μA

### NOTES ON USE

- A package of this IC is a surface mounted package 0603 size with backside electrode structure. Compare to other packages, fixation strength for the electrodes is weak due to its structure. Please keep away from mechanical stress to the product when mounting or after mounting.
- If the IC is mounted close to a board break line or fixed in screws, the IC or its electrodes may be caused damage as results of board deformation and mechanical stress.



## TYPICAL PERFORMANCE CHARACTERISTICS

(1) Forward Current vs. Forward Voltage

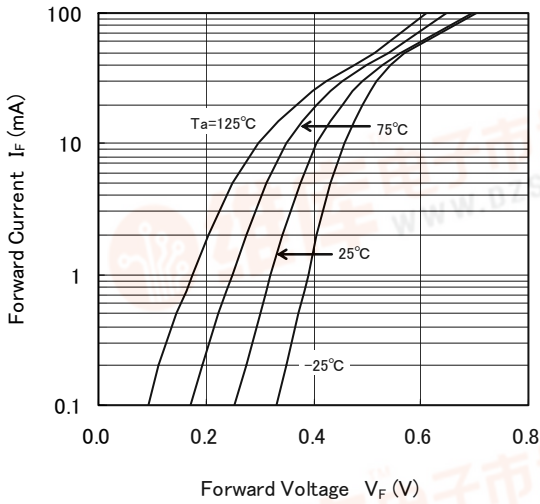

(2) Reverse Current vs. Reverse Voltage

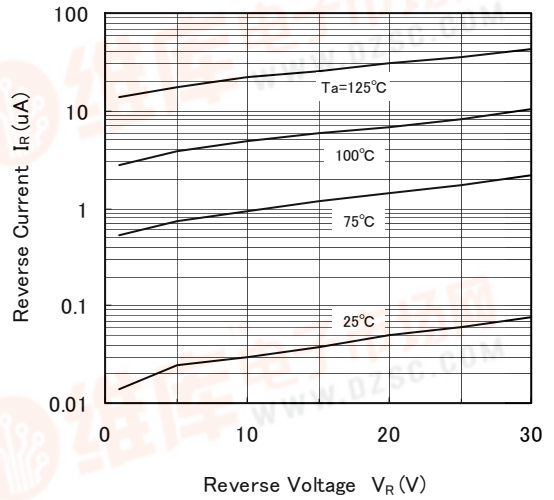

(3) Forward Voltage vs. Operating Temperature

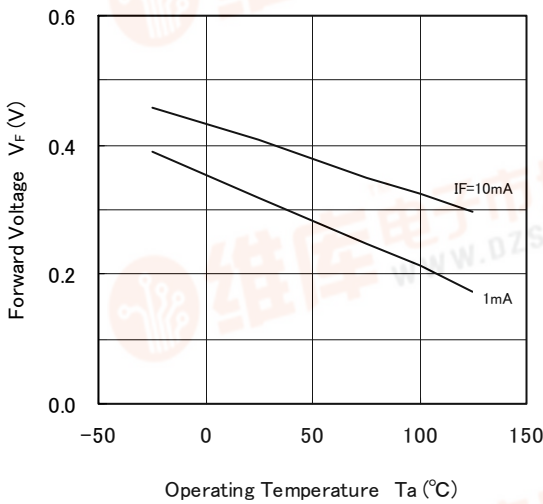

(4) Reverse Current vs. Operating Temperature

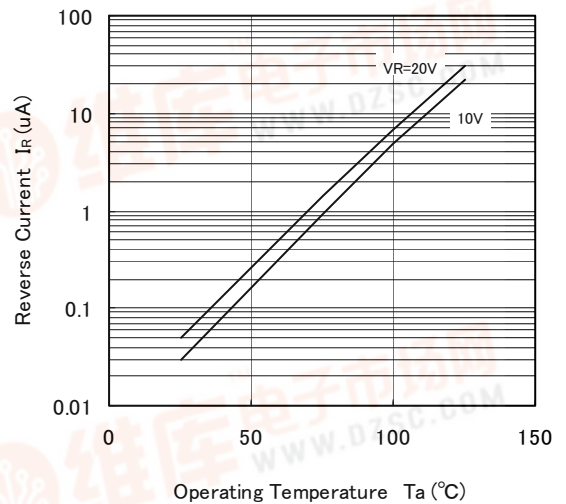

(5) Inter-Terminal Capacity vs. Reverse Voltage

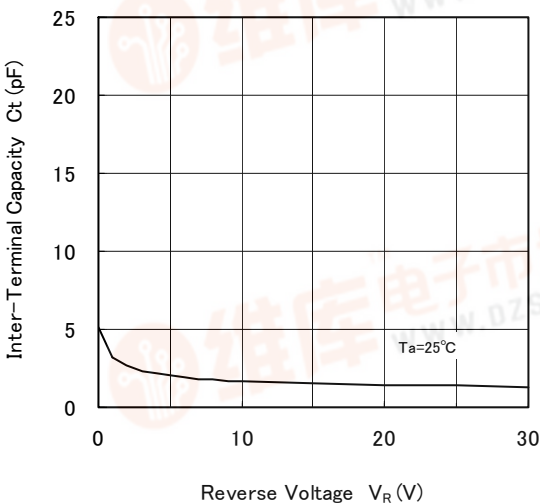

(6) Average Forward Current vs. Operating Temperature

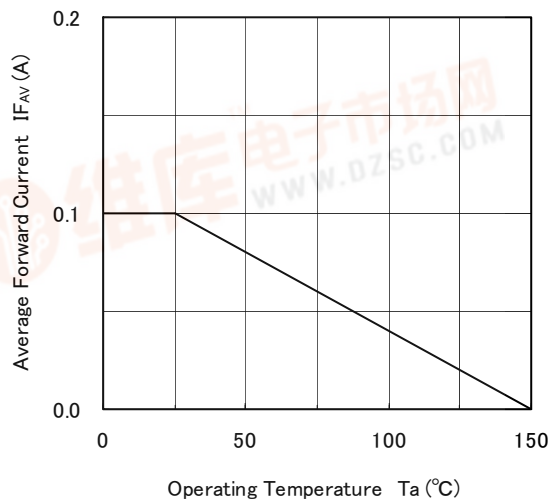

1. The products and product specifications contained herein are subject to change without notice to improve performance characteristics. Consult us, or our representatives before use, to confirm that the information in this datasheet is up to date.
2. We assume no responsibility for any infringement of patents, patent rights, or other rights arising from the use of any information and circuitry in this datasheet.
3. Please ensure suitable shipping controls (including fail-safe designs and aging protection) are in force for equipment employing products listed in this datasheet.
4. The products in this datasheet are not developed, designed, or approved for use with such equipment whose failure or malfunction can be reasonably expected to directly endanger the life of, or cause significant injury to, the user.  
(e.g. Atomic energy; aerospace; transport; combustion and associated safety equipment thereof.)
5. Please use the products listed in this datasheet within the specified ranges.  
Should you wish to use the products under conditions exceeding the specifications, please consult us or our representatives.
6. We assume no responsibility for damage or loss due to abnormal use.
7. All rights reserved. No part of this datasheet may be copied or reproduced without the prior permission of TOREX SEMICONDUCTOR LTD.

**TOREX SEMICONDUCTOR LTD.**