

[查询"B41691A5337Q007"供应商](#)



## Aluminum electrolytic capacitors

Axial-lead and soldering star capacitors

Series/Type: B41691, B41791

Date: November 2008

© EPCOS AG 2008. Reproduction, publication and dissemination of this publication, enclosures hereto and the information contained therein without EPCOS' prior express consent is prohibited.





Axial-lead and soldering star capacitors

B41691, B41791

Long useful life – up to 150 °C

#### Applications

- For automotive applications up to 140 °C

#### Features

- Long useful life, 2000 h at up to 150 °C
- Low ESR also at 63 V DC
- High ripple current capability
- High vibration resistance
- Shelf life up to 15 years at storage temperatures up to 40 °C.  
To ensure solderability, the capacitors should be built into the application within one year of delivery. After a total of two years' storage, the operating voltage must be applied for one hour to ensure the specified leakage current.

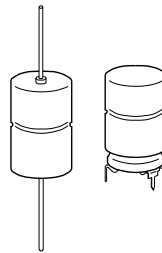

#### Construction

- Charge/discharge-proof, polar
- Aluminum case with insulating sleeve
- Negative pole connected to case

#### Terminals

- Axial leads, welded to ensure perfect electrical contact
- Also available with soldering stars

#### Taping and packing

- Axial-lead capacitors will be delivered in pallet package.  
Capacitors with  $d \times l \leq 16 \times 30$  mm are also available taped on reel.
- Soldering star capacitors are packed in cardboard.



B41691, B41791

Long useful life – up to 150 °C

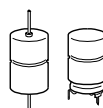

Specifications and characteristics in brief

Rated voltage $V_R$	25 ... 63 V DC						
Surge voltage $V_S$	$1.15 \cdot V_R$						
Rated capacitance $C_R$	100 ... 4000 $\mu\text{F}$						
Capacitance tolerance	$-10/+30\% \triangle Q$						
Leakage current $I_{\text{leak}}$ (5 min, 20 °C)	$I_{\text{leak}} \leq 0.006 \mu\text{A} \cdot \left( \frac{C_R}{\mu\text{F}} \cdot \frac{V_R}{V} \right) + 4 \mu\text{A}$						
Self-inductance ESL <sup>1)</sup>	Diameter d (mm)	12	14	16	18	20/21	
	Terminals	Length l (mm)					Approx. ESL (nH)
	axial	25	–	22	26	–	–
		29	–	–	–	–	38
		30	21	24	29	34	–
		39	–	–	33	38	45
	49	–	–	–	–	50	
soldering star	25	–	6	7	–	–	
	30	6	7	8	10	–	
	39	–	–	9	11	–	
Useful life	150 °C; $V_R$ ; $0.5 \cdot I_{AC,R}$	> 2000 h					Requirements: $\Delta C/C \leq \pm 30\%$ of initial value ESR $\leq 3$ times initial specified limit $I_{\text{leak}} \leq$ initial specified limit
	125 °C; $V_R$ ; $I_{AC,R}$	> 10000 h					
	125 °C; $V_R$ ; $I_{AC,max}$	> 4000 h					
	105 °C; $V_R$ ; $I_{AC,max}$	> 8000 h					
	85 °C; $V_R$ ; $I_{AC,max}$	> 15000 h					
40 °C; $V_R$ ; $2.1 \cdot I_{AC,R}$	> 500000 h						
Voltage endurance test	125 °C; $V_R$	5000 h	Post test requirements:				
			$\Delta C/C \leq \pm 10\%$ of initial value	ESR $\leq 1.3\%$ initial specified limit	$I_{\text{leak}} \leq$ initial specified limit		
Vibration resistance test	To IEC 60068-2-6, test Fc: Displacement amplitude 1.5 mm, at 10 Hz ... 2 kHz, acceleration max. 20 g, duration 3 × 2 h. Capacitor mounted by its wire leads at a distance of (6 ± 1) mm from the case and additionally clamped by the case.						
IEC climatic category	To IEC 60068-1: 55/125/56 (–55 °C/+125 °C/56 days damp heat test)						
Detail specification	Similar to CECC 30301-802						
Sectional specification	IEC 60384-4						

1) If optimum circuit design is used, the values are lower by 30%.

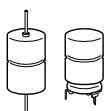

**B41691, B41791**

**Long useful life – up to 150 °C**

**Axial-lead capacitors**

**Dimensional drawing**

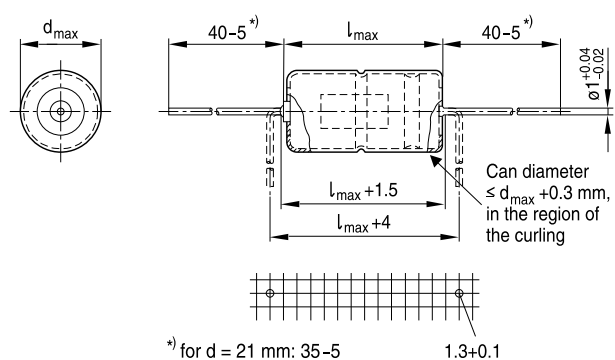

KAL0524-S-E

**Dimensions, weights and packing units**

d × l mm	d <sub>max</sub> × l <sub>max</sub> mm	Approx. weight g	Packing units (pcs.)	
			Pallet	Reel
12 × 30	12.5 × 30.5	5.1	288	450
14 × 25	14.5 × 25.5	5.7	200	350
14 × 30	14.5 × 30.5	6.8	200	350
16 × 30	16.5 × 30.5	8.9	180	250
16 × 39	16.5 × 40	11.7	180	—
18 × 30	18.5 × 30.5	11.1	160	—
18 × 39	18.5 × 40	14.7	160	—
20 × 29	20.5 × 29.5	13.5	140	—
21 × 39	21.5 × 40	20.0	140	—
21 × 49	21.5 × 50	25.0	110	—



B41691, B41791

Long useful life – up to 150 °C

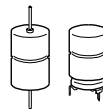

**Soldering star capacitors**

**Dimensional drawing**

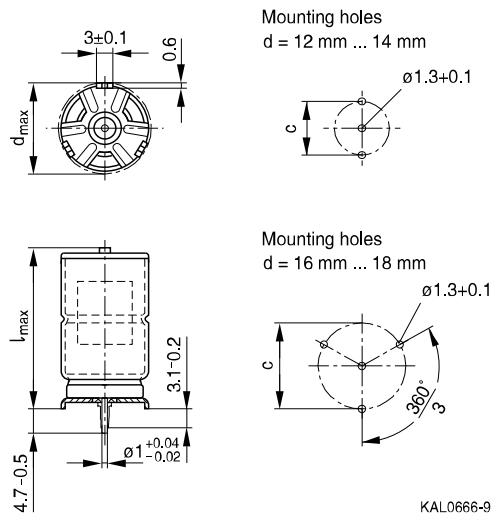

**Dimensions, weights and packing units**

d × l mm	d <sub>max</sub> × l <sub>max</sub> mm	c ±0.1 mm	Approx. weight g	Packing units pcs.
12 × 30	13.5 × 32	12.5	5.4	480
14 × 25	15.5 × 27	14.5	6.1	480
14 × 30	15.5 × 32	14.5	7.2	480
16 × 30	17.5 × 32	16.5	9.4	300
16 × 39	17.5 × 41.5	16.5	12.2	200
18 × 30	19.5 × 32	18.5	11.8	300
18 × 39	19.5 × 41.5	18.5	15.4	200

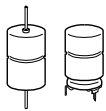

**B41691, B41791**

**Long useful life – up to 150 °C**

**Overview of available types**

V <sub>R</sub> (V DC)	25	40	63
	Case dimensions d × l (mm)		
C <sub>R</sub> (μF)			
100			12 × 30
150			14 × 25
220			14 × 30
330	12 × 30	12 × 30	
470	14 × 25	14 × 30	16 × 39 18 × 30
560			20 × 29
680		16 × 30	18 × 39
1000	16 × 30	16 × 39 18 × 30	21 × 39
1200		20 × 29	21 × 49
1500	16 × 39 18 × 30	18 × 39	
1800	20 × 29		
2000	18 × 39		
2200		21 × 39	
2700		21 × 49	
3000	21 × 39		
4000	21 × 49		



B41691, B41791

Long useful life – up to 150 °C

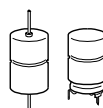

**Case dimensions and ordering codes**

$V_R$	$C_R$	Case dimensions	Ordering code	Ordering code	Ordering code
	100 Hz	$d \times l$	Axial pallet	Axial reel	Soldering star
	20 °C	mm			
V DC	$\mu F$				
25	330	12 × 30	B41691A5337Q007	B41691A5337Q009	B41791A5337Q000
	470	14 × 25	B41691A5477Q007	B41691A5477Q009	B41791A5477Q000
	1000	16 × 30	B41691A5108Q007	B41691A5108Q009	B41791A5108Q000
	1500	16 × 39	B41691A5158Q007		B41791A5158Q000
	1500 ▽	18 × 30	B41691B5158Q007		B41791B5158Q000
	1800	20 × 29	B41691A5188Q007		
	2000	18 × 39	B41691A5208Q007		B41791A5208Q000
	3000	21 × 39	B41691A5308Q007		
	4000	21 × 49	B41691A5408Q007		
40	330	12 × 30	B41691A7337Q007	B41691A7337Q009	B41791A7337Q000
	470	14 × 30	B41691A7477Q007	B41691A7477Q009	B41791A7477Q000
	680	16 × 30	B41691A7687Q007	B41691A7687Q009	B41791A7687Q000
	1000	16 × 39	B41691A7108Q007		B41791A7108Q000
	1000 ▽	18 × 30	B41691B7108Q007		B41791B7108Q000
	1200	20 × 29	B41691A7128Q007		
	1500	18 × 39	B41691A7158Q007		B41791A7158Q000
	2200	21 × 39	B41691A7228Q007		
	2700	21 × 49	B41691A7278Q007		
63	100	12 × 30	B41691A8107Q007	B41691A8107Q009	B41791A8107Q000
	150	14 × 25	B41691A8157Q007	B41691A8157Q009	B41791A8157Q000
	220	14 × 30	B41691A8227Q007	B41691A8227Q009	B41791A8227Q000
	470	16 × 39	B41691A8477Q007		B41791A8477Q000
	470 ▽	18 × 30	B41691B8477Q007		B41791B8477Q000
	560	20 × 29	B41691A8567Q007		
	680	18 × 39	B41691A8687Q007		B41791A8687Q000
	1000	21 × 39	B41691A8108Q007		
	1200	21 × 49	B41691A8128Q007		

▽ Variant with different case dimensions

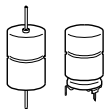

B41691, B41791

Long useful life – up to 150 °C

Technical data

$C_R$ 100 Hz 20 °C μF	$ESR_{typ}$ 100 Hz 20 °C mΩ	$ESR_{max}$ 100 Hz 20 °C mΩ	$ESR_{max}$ 100 Hz -40 °C mΩ	$ESR_{max}$ 10 kHz 20 °C mΩ	$Z_{max}$ 100 kHz 20 °C mΩ	$I_{AC,max}$ 10 kHz 85 °C A	$I_{AC,max}$ 10 kHz 105 °C A	$I_{AC,max}$ 10 kHz 125 °C A	$I_{AC,R}$ 10 kHz 125 °C A	$I_{AC,max}$ 10 kHz 150 °C A
<b><math>V_R = 25</math> V DC</b>										
330	175	290	1600	150	150	4.8	4.3	3.4	2.1	1.05
470	125	210	1200	110	102	5.1	4.6	3.7	2.2	1.1
1000	65	110	550	60	55	7.3	6.5	5.2	3.2	1.6
1500	44	73	370	42	39	10.1	9.0	7.2	4.4	2.2
1500 ▽	42	69	370	38	35	10.5	9.4	7.5	4.6	2.3
1800	35	58	300	32	30	11.3	10.1	8.1	4.9	2.4
2000	31	50	270	28	26	14.2	12.7	10.2	6.2	3.1
3000	22	37	180	22	21	16.1	14.3	11.5	7.0	3.5
4000	17	29	135	17	16	20.2	18	14.5	8.8	4.4
<b><math>V_R = 40</math> V DC</b>										
330	150	240	1250	115	105	5.3	4.8	3.8	2.3	1.15
470	110	170	900	85	77	6.4	5.7	4.6	2.8	1.4
680	80	120	600	65	60	7.3	6.5	5.2	3.1	1.5
1000	55	80	410	45	41	10.0	8.9	7.2	4.3	2.1
1000 ▽	52	77	410	40	37	10.3	9.2	7.4	4.5	2.2
1200	37	55	320	35	33	11.2	10.0	8.0	4.9	2.4
1500	35	53	270	27	25	14.2	12.7	10.2	6.2	3.1
2200	26	39	185	21	20	16.1	14.3	11.5	7.0	3.5
2700	21	30	150	18	17	20.1	17.9	14.4	8.7	4.3
<b><math>V_R = 63</math> V DC</b>										
100	350	550	1900	160	150	4.7	4.2	3.3	2.0	1.0
150	240	380	1300	115	110	5.1	4.5	3.6	2.2	1.1
220	165	260	900	80	76	6.5	5.8	4.6	2.8	1.4
470	80	120	410	42	40	10.1	9.0	7.2	4.4	2.2
470 ▽	77	114	410	38	36	10.5	9.3	7.5	4.5	2.3
560	65	75	320	34	33	11.3	10.1	8.1	4.9	2.4
680	54	78	280	27	25	14.3	12.8	10.3	6.2	3.1
1000	38	47	200	21	20	16.1	14.3	11.5	7.0	3.5
1200	32	38	160	17	16	20.1	18.0	14.4	8.8	4.4

▽ Variant with different case dimensions



B41691, B41791

Long useful life – up to 150 °C

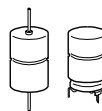

**Useful life**

depending on ambient temperature  $T_A$  under ripple current operating conditions at  $V_R^{1)}$

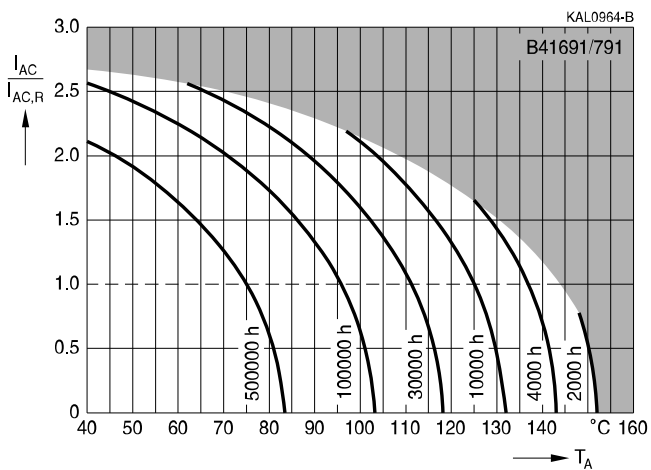

**Useful life**

depending on case temperature  $T_C$  under ripple current operating conditions at  $V_R^{1)}$

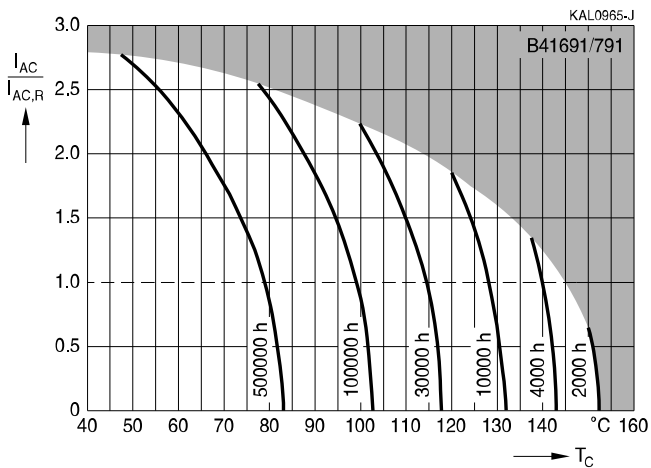

1) Refer to chapter "General technical information, 5.3 Calculation of useful life" for an explanation on how to interpret the useful life graphs.

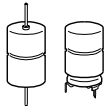

B41691, B41791

Long useful life – up to 150 °C

**Frequency factor of permissible ripple current  $I_{AC}$  versus frequency  $f$**

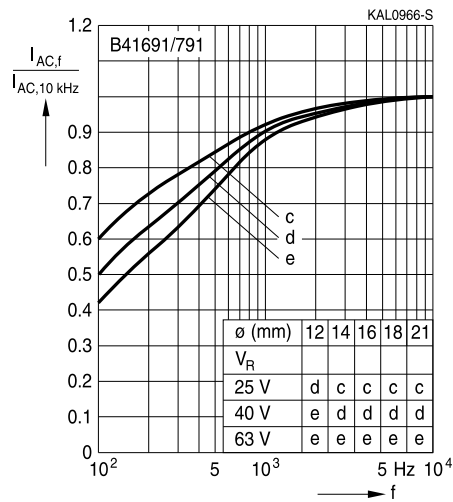

**Frequency characteristics of ESR**  
Typical behavior

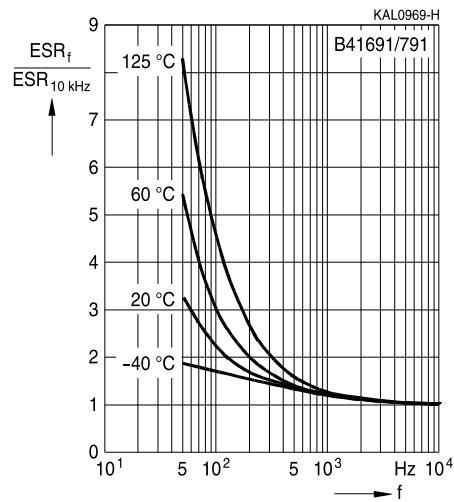

**Equivalent series resistance ESR versus frequency  $f$**

Typical behavior for 470  $\mu$ F/63 V

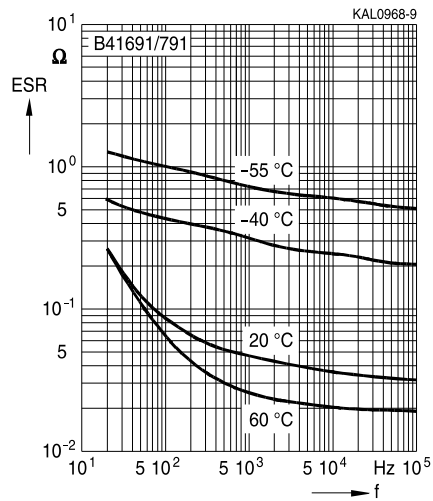

**Impedance Z versus frequency  $f$**

Typical behavior for 470  $\mu$ F/63 V

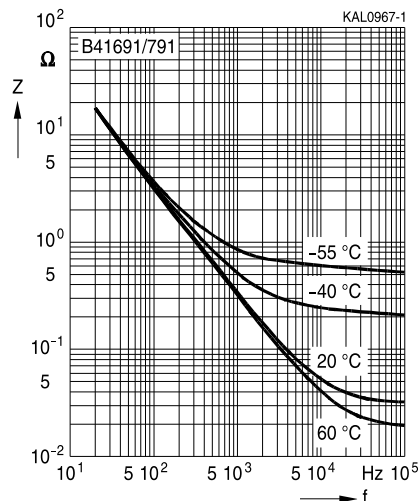



B41691, B41791

Long useful life – up to 150 °C

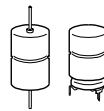

## Cautions and warnings

### Personal safety

The electrolytes used by EPCOS have not only been optimized with a view to the intended application, but also with regard to health and environmental compatibility. They do not contain any solvents that are detrimental to health, e.g. dimethyl formamide (DMF) or dimethyl acetamide (DMAC).

Furthermore, part of the high-voltage electrolytes used by EPCOS are self-extinguishing. They contain flame-retarding substances which will quickly extinguish any flame that may have been ignited.

As far as possible, EPCOS does not use any dangerous chemicals or compounds to produce operating electrolytes. However, in exceptional cases, such materials must be used in order to achieve specific physical and electrical properties because no safe substitute materials are currently known. However, the amount of dangerous materials used in our products has been limited to an absolute minimum. Nevertheless, the following rules should be observed when handling Al electrolytic capacitors:

- Any escaping electrolyte should not come into contact with eyes or skin.
- If electrolyte does come into contact with the skin, wash the affected parts immediately with running water. If the eyes are affected, rinse them for 10 minutes with plenty of water. If symptoms persist, seek medical treatment.
- Avoid breathing in electrolyte vapor or mists. Workplaces and other affected areas should be well ventilated. Clothing that has been contaminated by electrolyte must be changed and rinsed in water.

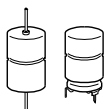

**B41691, B41791**

**Long useful life – up to 150 °C**

**Product safety**

The table below summarize the safety instructions that must be observed without fail. A detailed description can be found in the relevant sections of chapter "General technical information".

Topic	Safety information	Reference Chapter "General technical information"
Polarity	Make sure that polar capacitors are connected with the right polarity.	1 "Basic construction of aluminum electrolytic capacitors"
Reverse voltage	Voltages polarity classes should be prevented by connecting a diode.	3.1.6 "Reverse voltage"
Upper category temperature	Do not exceed the upper category temperatur.	7.2 "Maximum permissible operating temperature"
Maintenance	Make periodic inspections of the capacitors. Before the inspection, make sure that the power supply is turned off and carefully discharge the electricity of the capacitors. Do not apply any mechanical stress to the capacitor terminals.	10 "Maintenance"
Mounting position of screw terminal capacitors	Do not mount the capacitor with the terminals (safety vent) upside down.	11.1 "Mounting positions of capacitors with screw terminals"
Mounting of single-ended capacitors	The internal structure of single-ended capacitors might be damaged if excessive force is applied to the lead wires. Avoid any compressive, tensile or flexural stress. Do not move the capacitor after soldering to PC board. Do not pick up the PC board by the soldered capacitor. Do not insert the capacitor on the PC board with a hole space different to the lead space specified.	11.4 "Mounting considerations for single-ended capacitors"
Robustness of terminals	The following maximum tightening torques must not be exceeded when connecting screw terminals: M5: 2 Nm M6: 2.5 Nm	11.3 "Mounting torques"
Soldering	Do not exceed the specified time or temperature limits during soldering.	11.5 "Soldering"



B41691, B41791

Long useful life – up to 150 °C

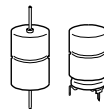

Topic	Safety information	Reference Chapter "General technical information"
Soldering, cleaning agents	Do not allow halogenated hydrocarbons to come into contact with aluminum electrolytic capacitors.	11.6 "Cleaning agents"
Passive flammability	Avoid external energy, such as fire or electricity.	8.1 "Passive flammability"
Active flammability	Avoid overload of the capacitors.	8.2 "Active flammability"
		Reference Chapter "Capacitors with screw terminals"
Breakdown strength of insulating sleeves	Do not damage the insulating sleeve, especially when ring clips are used for mounting.	"Screw terminals - accessories"

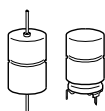

**B41691, B41791**

**Long useful life – up to 150 °C**

Symbols and terms

Symbol	English	German
C	Capacitance	Kapazität
C <sub>R</sub>	Rated capacitance	Nennkapazität
C <sub>S</sub>	Series capacitance	Serienkapazität
C <sub>S,T</sub>	Series capacitance at temperature T	Serienkapazität bei Temperatur T
C <sub>f</sub>	Capacitance at frequency f	Kapazität bei Frequenz f
d	Case diameter, nominal dimension	Gehäusedurchmesser, Nennmaß
d <sub>max</sub>	Maximum case diameter	Maximaler Gehäusedurchmesser
ESL	Self-inductance	Eigeninduktivität
ESR	Equivalent series resistance	Ersatzserienwiderstand
ESR <sub>f</sub>	Equivalent series resistance at frequency f	Ersatzserienwiderstand bei Frequenz f
ESR <sub>T</sub>	Equivalent series resistance at temperature T	Ersatzserienwiderstand bei Temperatur T
f	Frequency	Frequenz
I	Current	Strom
I <sub>AC</sub>	Alternating current (ripple current)	Wechselstrom
I <sub>AC,rms</sub>	Root-mean-square value of alternating current	Wechselstrom, Effektivwert
I <sub>AC,f</sub>	Ripple current at frequency f	Wechselstrom bei Frequenz f
I <sub>AC,max</sub>	Maximum permissible ripple current	Maximal zulässiger Wechselstrom
I <sub>AC,R</sub>	Rated ripple current	Nennwechselstrom
I <sub>AC,R (B)</sub>	Rated ripple current for base cooling	Nennwechselstromstrom für Bodenkühlung
I <sub>leak</sub>	Leakage current	Ableitstrom
I <sub>leak,op</sub>	Operating leakage current	Ableitstrom bei Betrieb
l	Case length, nominal dimension	Gehäuselänge, Nennmaß
l <sub>max</sub>	Maximum case length (without terminals and mounting stud)	Maximale Gehäuselänge (ohne Anschlüsse und Gewindebolzen)
R	Resistance	Widerstand
R <sub>ins</sub>	Insulation resistance	Isolationswiderstand
R <sub>symm</sub>	Balancing resistance	Symmetrierwiderstand
T	Temperature	Temperatur
ΔT	Temperature difference	Temperaturdifferenz
T <sub>A</sub>	Ambient temperature	Umgebungstemperatur
T <sub>C</sub>	Case temperature	Gehäusetemperatur
T <sub>B</sub>	Capacitor base temperature	Temperatur des Becherbodens
t	Time	Zeit
Δt	Period	Zeitraum
t <sub>b</sub>	Service life (operating hours)	Brauchbarkeitsdauer (Betriebszeit)



B41691, B41791

Long useful life – up to 150 °C

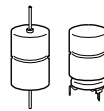

Symbol	English	German
V	Voltage	Spannung
V <sub>F</sub>	Forming voltage	Formierspannung
V <sub>op</sub>	Operating voltage	Betriebsspannung
V <sub>R</sub>	Rated voltage, DC voltage	Nennspannung, Gleichspannung
V <sub>S</sub>	Surge voltage	Spitzenspannung
X <sub>C</sub>	Capacitive reactance	Kapazitiver Blindwiderstand
X <sub>L</sub>	Inductive reactance	Induktiver Blindwiderstand
Z	Impedance	Scheinwiderstand
Z <sub>T</sub>	Impedance at temperature T	Scheinwiderstand bei Temperatur T
tan δ	Dissipation factor	Verlustfaktor
λ	Failure rate	Ausfallrate
ε <sub>0</sub>	Absolute permittivity	Elektrische Feldkonstante
ε <sub>r</sub>	Relative permittivity	Dielektrizitätszahl
ω	Angular velocity; 2 · π · f	Kreisfrequenz; 2 · π · f

**Notes**

All dimensions are given in mm.



#### Important notes

The following applies to all products named in this publication:

1. Some parts of this publication contain **statements about the suitability of our products for certain areas of application**. These statements are based on our knowledge of typical requirements that are often placed on our products in the areas of application concerned. We nevertheless expressly point out **that such statements cannot be regarded as binding statements about the suitability of our products for a particular customer application**. As a rule, EPCOS is either unfamiliar with individual customer applications or less familiar with them than the customers themselves. For these reasons, it is always ultimately incumbent on the customer to check and decide whether an EPCOS product with the properties described in the product specification is suitable for use in a particular customer application.
2. We also point out that **in individual cases, a malfunction of electronic components or failure before the end of their usual service life cannot be completely ruled out in the current state of the art, even if they are operated as specified**. In customer applications requiring a very high level of operational safety and especially in customer applications in which the malfunction or failure of an electronic component could endanger human life or health (e.g. in accident prevention or lifesaving systems), it must therefore be ensured by means of suitable design of the customer application or other action taken by the customer (e.g. installation of protective circuitry or redundancy) that no injury or damage is sustained by third parties in the event of malfunction or failure of an electronic component.
3. **The warnings, cautions and product-specific notes must be observed.**
4. In order to satisfy certain technical requirements, **some of the products described in this publication may contain substances subject to restrictions in certain jurisdictions (e.g. because they are classed as hazardous)**. Useful information on this will be found in our Material Data Sheets on the Internet ([www.epcos.com/material](http://www.epcos.com/material)). Should you have any more detailed questions, please contact our sales offices.
5. We constantly strive to improve our products. Consequently, **the products described in this publication may change from time to time**. The same is true of the corresponding product specifications. Please check therefore to what extent product descriptions and specifications contained in this publication are still applicable before or when you place an order. We also **reserve the right to discontinue production and delivery of products**. Consequently, we cannot guarantee that all products named in this publication will always be available. The aforementioned does not apply in the case of individual agreements deviating from the foregoing for customer-specific products.
6. Unless otherwise agreed in individual contracts, **all orders are subject to the current version of the "General Terms of Delivery for Products and Services in the Electrical Industry" published by the German Electrical and Electronics Industry Association (ZVEI)**.
7. The trade names EPCOS, BAOKE, Alu-X, CeraDiode, CSSP, CTVS, DSSP, MiniBlue, MKK, MLSC, MotorCap, PCC, PhaseCap, PhaseMod, SIFERRIT, SIFI, SIKOREL, SilverCap, SIMDAD, SIMID, SineFormer, SIOV, SIP5D, SIP5K, ThermoFuse, WindCap are **trademarks registered or pending** in Europe and in other countries. Further information will be found on the Internet at [www.epcos.com/trademarks](http://www.epcos.com/trademarks).

**This datasheet has been downloaded from:**

**[www.EEworld.com.cn](http://www.EEworld.com.cn)**

**Free Download**

**Daily Updated Database**

**100% Free Datasheet Search Site**

**100% Free IC Replacement Search Site**

**Convenient Electronic Dictionary**

**Fast Search System**

**[www.EEworld.com.cn](http://www.EEworld.com.cn)**