



**1.09mm (.043") by
1.17mm (.046") Pitch
LGA Socket 771**

FEATURES AND SPECIFICATIONS

[查询"47213-1015"供应商](#)

Molex offers the 771-pin LGA CPU Socket for the Intel Dempsey Platform Processor

Socket 771 is the first Computer Processing Unit (CPU) socket to be used on the server/workstation industry featuring the Land Grid Array (LGA) contact design. This socket is commonly known as Socket J, Socket 771 and LGA 771. This socket mates with the 771 LGA CPU package (gold pads) to form the processing unit of the application. Previous design uses the Pin Grid Array (PGA) socket or Micro-PGA socket (such as socket 604) mated with PGA CPU package. The 771-pin LGA CPU and Socket will replace the Socket 604 in Intel®Xeon® processor line.

Molex's high density LGA sockets features our low profile design, the shepard hook actuation lever and a flat or raised pick and place cover for the assembly process. All Molex's LGA sockets comes with lead or lead-free BGA solder balls.

**47213
Vertical
Surface Mount**

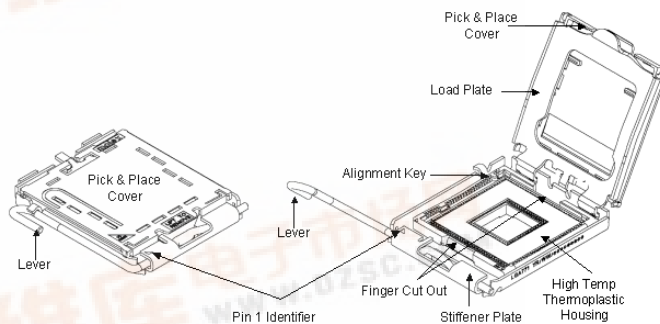

Features	Benefits
<ul style="list-style-type: none"> High-temperature thermoplastic housing 	<ul style="list-style-type: none"> Withstands lead-free processing
<ul style="list-style-type: none"> Pick-&-place cover and Jedec hard packaging tray 	<ul style="list-style-type: none"> Facilitates automation socket placement
<ul style="list-style-type: none"> LGA contact/BGA solder 	<ul style="list-style-type: none"> Prevents CPU misalignment
<ul style="list-style-type: none"> Lead free BGA solder balls 	<ul style="list-style-type: none"> Compliant with environmental needs
<ul style="list-style-type: none"> Shepard hook actuation lever 	<ul style="list-style-type: none"> For easy actuation
<ul style="list-style-type: none"> Flat or raised pick & place cover 	<ul style="list-style-type: none"> Raised cover facilitates easy removal
<ul style="list-style-type: none"> Visible triangle pin 1 identification on housing, pick & place cover, stiffener plate. 	<ul style="list-style-type: none"> Ensure correct CPU loading
<ul style="list-style-type: none"> West alignment key. 	<ul style="list-style-type: none"> Prevent Socket 775 CPU from mating to socket 771.

- 2 finger cutouts on north and south side
- For easy CPU removal

SPECIFICATIONS

Reference Information

Packaging: JEDEC Thick Handling Hard Tray
UL File No.: E29179
Mates With: Intel®Xeon® Processor family(771-pin Package)
Designed In: Millimeters

Electrical

Voltage: 30V
Current: 0.8A
Contact Resistance: 15.2 milliohms max. average,
 28.0 milliohms max. chain
Dielectric Withstanding Voltage: 360V AC
Insulation Resistance: 500 Megohms min.

Mechanical

Insertion Force to Socket: Zero Insertion Force
Durability: 20 cycles

Physical

Housing: LCP, UL 94V-0
Contact: Copper Alloy
Plating:
 Contact Area — 0.38 um (15u") Gold
 Solder Tail Area —
 Underplating — Nickel
Operating Temperature: -40 to +90°C



MARKETS AND APPLICATIONS

[查询"47213-1015"供应商](#)



**1.09mm (.043") by
1.17mm (.046") Pitch
LGA Socket 771**

- **Workstation/Low End Server**

**47213
Vertical
Surface Mount**



ORDERING INFORMATION

Lead-Free Order No.	Tin-Lead Order No.	Description
47213-0015	47213-0010	1.09mm (.043") by 1.17mm (.046") Pitch LGA Socket, 771 Circuits, 15u" Gold Plating, Shepherd Hook Lever, Flat Pick & Place Cover
47213-1015	47213-1010	1.09mm (.043") by 1.17mm (.046") Pitch LGA Socket, 771 Circuits, 15u" Gold Plating, Shepherd Hook Lever, Raised Pick & Place Cover
47213-0005	47213-0000	1.09mm (.043") by 1.17mm (.046") Pitch LGA Socket, 771 Circuits, 30u" Gold Plating, Shepherd Hook Lever, Raised Pick & Place Cover

Intel®Xeon® is a registered trademark of Intel.



Bringing People & Technology Together, WorldwideSM

Americas Headquarters
2222 Wellington Ct.
Lisle, Illinois 60532 USA
1-800-78MOLEX
amerinfo@molex.com

Far East North Headquarters
Yamato, Kanagawa, Japan
81-462-65-2324
feninfo@molex.com

Far East South Headquarters
Jurong, Singapore
65-6-268-6868
fesinfo@molex.com

European Headquarters
Munich, Germany
49-89-413092-0
eurinfo@molex.com

Corporate Headquarters
2222 Wellington Ct.
Lisle, Illinois 60532 USA
630-969-4550

Visit our Web site at <http://www.molex.com>