

[查询"39170-1050"供应商](#)

39170

Interface Modules provide a cost effective and simple transition from cable assemblies to discrete wiring

Interface modules are DIN-Rail mounted, PCB-based interconnect devices that provide an expedient and simplistic means to transition between system Input/Output (I/O) connectors and field equipment. Modules incorporate terminal blocks and other high-density electronic connectors.

Molex's Interface Modules have pre-drilled component holes, allowing for the addition of other electronic components, if necessary. Typical additions and modifications to the standard modules may include resistors, capacitors, diodes or light emitting diodes (LEDs) for increased functionality.

Custom interface modules are also available and allow the user to develop a connector interface system to meet virtually any application and product requirement. Molex works seamlessly with our customers to develop application specific modules to meet unique design requirements.

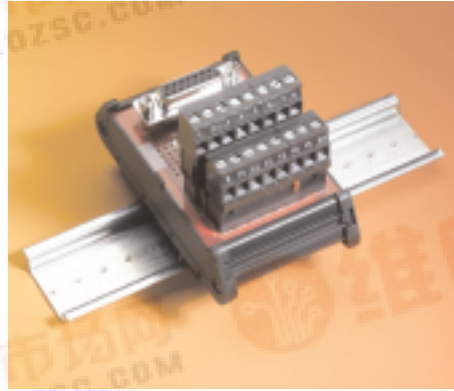

D-Sub module

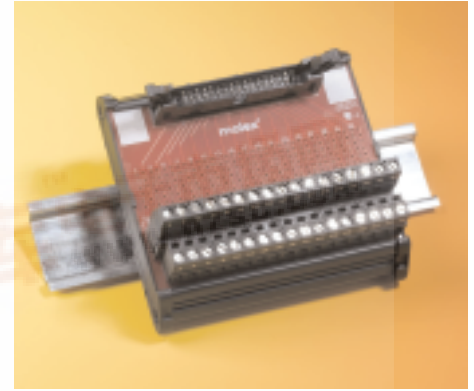

Ribbon-Cable module

Features and Benefits

- High-reliability rising cage clamp connection technology (on terminal blocks) provides reliable connection without strand damage
- High-packing density of compact modules enables space savings where real estate is limited
- Blocks are clearly marked to reduce wiring errors and installation time
- Fixed or pluggable terminal blocks available for discrete wire connections providing design flexibility
- Pre-drilled component holes allow for the easy addition of other components
- Pluggable terminal blocks are provided with coding pins (keys) to prevent mis-mating

SPECIFICATIONS

Reference Information

Packaging: Box
Designed In: Inches

Electrical

Terminal Blocks

Voltage: 300V
Current: 15.0A max.
Dielectric Withstanding Voltage: 4000V DC
Insulation Resistance: 5000 Megohms min.

Ribbon Cable Connector

Voltage: 120V
Current: 1.0A
Dielectric Withstanding Voltage: 1000V RMS
Insulation Resistance: 1000 Megohms min.

D-Sub Connector

Voltage: 125V
Current: 2.50A
Dielectric Withstanding Voltage: 500V RMS
Insulation Resistance: 1000 Megohms min.

Physical

Terminal Blocks

Housing: PA Polyamide (Nylon 6/6)
Contact: Phosphor Bronze (CuSn)
Plating: Contact Area — Tin (Sn)
Operating Temperature: +110°C max.
Flammability: UL 94V-0
Tightening Torque-Recommended: 0.56Nm (5 in. lbs)

APPLICATIONS

- Machine Builders
 - Semiconductor equipment
 - Mill machines
 - Compressor systems
- Process Control Equipment/Systems
 - Instrumentation
 - Distributed Control Systems (DCS)
 - Power generation equipment
- Industrial Control Equipment
 - PLCs
 - Micro-controllers
 - Motion controllers
- Material Handling Equipment
 - Conveyor systems
 - Elevators/people movers
 - Automated warehouse controls
- Transportation
 - Signal control
 - Railway switching
 - Jetway systems
- Construction Equipment
 - Scissor lifts
 - Beam lifts

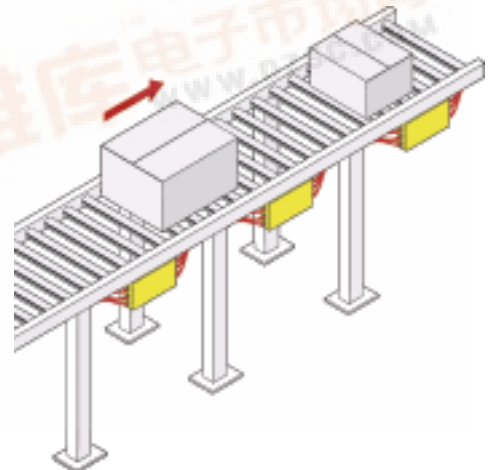

[查询"39170-1050"供应商](#)

39170

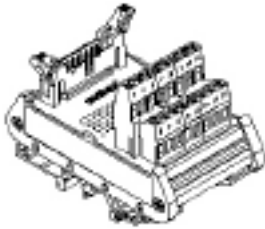

Ribbon-Cable Connector to Fixed 5.08mm (.200") Terminal Block

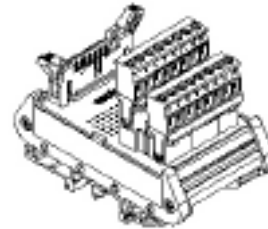

Ribbon-Cable Connector to Pluggable 5.08mm (.200") Terminal Block

Circuits	Order No.		Dimensions
	Ribbon-Cable Connector to Fixed Mount 5.08mm (.200") Terminal Block	Ribbon-Cable Connector to Pluggable 5.08mm (.200") Terminal Block	Length
14	39170-1014	39170-1114	50.80mm (2.000")
16	39170-1016	39170-1116	53.30mm (2.100")
20	39170-1020	39170-1120	61.00mm (2.400")
26	39170-1026	39170-1126	76.20mm (3.000")
34	39170-1034	39170-1134	95.00mm (3.740")
40	39170-1040	39170-1140	111.50mm (4.390")
50	39170-1050	39170-1150	135.60mm (5.340")

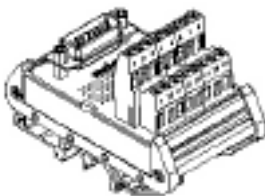

Male D-Sub Connector to Fixed 5.08mm (.200") Terminal Block

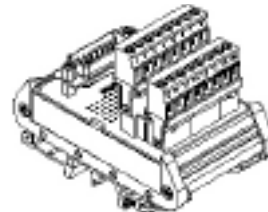

Male D-Sub Connector to Pluggable 5.08mm (.200") Terminal Block

Circuits	Order No.		Dimensions
	Male-D Sub Connector to Fixed Mount 5.08mm (.200") Terminal Block	Male-D Sub Connector to Pluggable 5.08mm (.200") Terminal Block	Length
9	39170-2009	39170-2109	39.40mm (1.550")
15	39170-2015	39170-2115	54.40mm (2.140")
25	39170-2025	39170-2125	79.80mm (3.140")
37	39170-2037	39170-2137	106.40mm (4.190")
50	39170-2050	39170-2150	142.00mm (5.590")

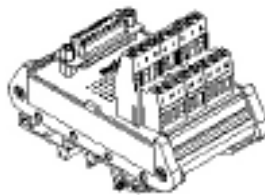

Female D-Sub Connector to Fixed 5.08mm (.200") Terminal Block

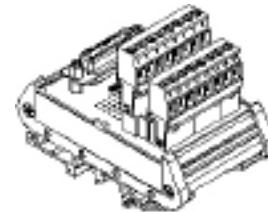

Female D-Sub Connector to Pluggable 5.08mm (.200") Terminal Block

Circuits	Order No.		Dimensions
	Female-D Sub Connector to Fixed Mount 5.08mm (.200") Terminal Block	Female-D Sub Connector to Pluggable 5.08mm (.200") Terminal Block	Length
9	39170-3009	39170-3109	39.40mm (1.550")
15	39170-3015	39170-3115	54.40mm (2.140")
25	39170-3025	39170-3125	79.80mm (3.140")
37	39170-3037	39170-3137	106.40mm (4.190")
50	39170-3050	39170-3150	142.00mm (5.590")

Americas Headquarters
Lisle, Illinois 60532 U.S.A.
1-800-78MOLEX
amerinfo@molex.com

Far East North Headquarters
Yamato, Kanagawa, Japan
81-462-65-2324
feninfo@molex.com

Far East South Headquarters
Jurong, Singapore
65-6-268-6868
fesinfo@molex.com

European Headquarters
Munich, Germany
49-89-413092-0
eurinfo@molex.com

Corporate Headquarters
2222 Wellington Ct.
Lisle, IL 60532 U.S.A.
630-969-4550
Fax:630-969-1352

Visit our Web site at <http://www.molex.com/product/tblocks.html>