

[查询"B41796B7158Q000"供应商](#)



## Aluminum electrolytic capacitors

Axial-lead and soldering star capacitors

Series/Type: B41696, B41796

Date: November 2008

© EPCOS AG 2008. Reproduction, publication and dissemination of this publication, enclosures hereto and the information contained therein without EPCOS' prior express consent is prohibited.





Axial-lead and soldering star capacitors

B41696, B41796

Low ESR, compact – 125 °C

#### Applications

- For compact design in automotive applications

#### Features

- High ripple current capability
- High vibration resistance
- Very low ESR at temperature down to –55 °C
- Compact and small design
- High reliability
- Shelf life up to 15 years at storage temperatures up to 40 °C.  
To ensure solderability, the capacitors should be built into the application within one year of delivery. After a total of two years' storage, the operating voltage must be applied for one hour to ensure the specified leakage current.

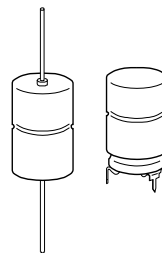

#### Construction

- Charge/discharge-proof, polar
- Aluminum case with insulating sleeve
- Negative pole connected to case

#### Terminals

- Axial-leads, welded to ensure perfect electrical contact
- Also available with soldering stars

#### Taping and packing

- Axial-lead capacitors will be delivered in pallet package.  
Capacitors with  $d \times l \leq 16 \times 30$  mm are also available taped on reel.
- Soldering star capacitors are packed in cardboard.



B41696, B41796

Low ESR, compact – 125 °C

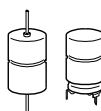

Specifications and characteristics in brief

Rated voltage $V_R$	25 and 40 V DC						
Surge voltage $V_S$	$1.15 \cdot V_R$						
Rated capacitance $C_R$	470 ... 6800 $\mu$ F						
Capacitance tolerance	-10/+30% $\triangle$ Q						
Leakage current $I_{leak}$ (5 min, 20 °C)	$I_{leak} \leq 0.006 \mu A \cdot \left( \frac{C_R}{\mu F} \cdot \frac{V_R}{V} \right) + 4 \mu A$						
Self-inductance ESL <sup>1)</sup>	Diameter d (mm)		12	14	16	18	20/21
	Terminals	Length l (mm)	Approx. ESL (nH)				
	axial	25	–	22	26	–	–
		29	–	–	–	–	38
		30	21	24	29	34	–
		39	–	–	33	38	45
	49	–	–	–	–	50	
soldering star	25	–	6	7	–	–	
	30	6	7	8	10	–	
	39	–	–	9	11	–	
Useful life	125 °C; $V_R$ ; $I_{AC,R}$		Requirements:				
	85 °C; $V_R$ ; $I_{AC,max}$		$\Delta C/C \leq \pm 30\%$ of initial value				
	40 °C; $V_R$ ; $2.9 \cdot I_{AC,R}$		ESR $\leq 3$ times initial specified limit				
Voltage endurance test	125 °C; $V_R$		Post test requirements:				
	2000 h		$\Delta C/C \leq \pm 10\%$ of initial value				
			ESR $\leq 1.3\%$ initial specified limit				
Vibration resistance test			$I_{leak} \leq$ initial specified limit				
	To IEC 60068-2-6, test Fc:						
	Displacement amplitude 1.5 mm, at 10 Hz ... 2 kHz, acceleration max. 20 g, duration 3 $\times$ 2 h. Capacitor mounted by its wire leads at a distance of (6 $\pm$ 1) mm from the case and additionally clamped by the case.						
IEC climatic category	To IEC 60068-1: 55/125/56 (-55 °C/+125 °C/56 days damp heat test)						
Detail specification	Similar to CECC 30301-802						
Sectional specification	IEC 60384-4						

1) If optimum circuit design is used, the values are lower by 30%.

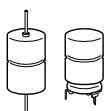

**B41696, B41796**

**Low ESR, compact – 125 °C**

**Axial-lead capacitors**

**Dimensional drawing**

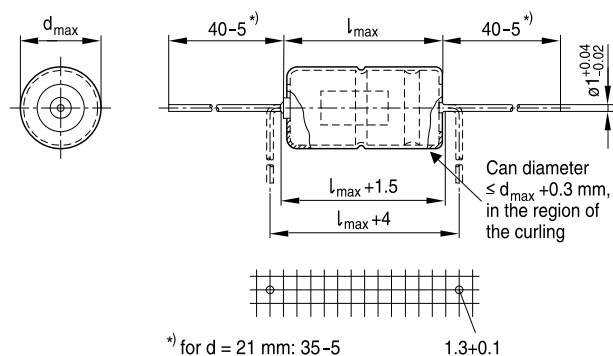

KAL0524-S-E

**Dimensions, weights and packing units**

d × l mm	d <sub>max</sub> × l <sub>max</sub> mm	Approx. weight g	Packing units (pcs.)	
			Pallet	Reel
12 × 30	12.5 × 30.5	5.1	288	450
14 × 25	14.5 × 25.5	5.7	200	350
14 × 30	14.5 × 30.5	6.8	200	350
16 × 30	16.5 × 30.5	8.9	180	250
16 × 39	16.5 × 40	11.7	180	—
18 × 30	18.5 × 30.5	11.1	160	—
18 × 39	18.5 × 40	14.7	160	—
20 × 29	20.5 × 29.5	13.5	140	—
21 × 39	21.5 × 40	20.0	140	—
21 × 49	21.5 × 50	25.0	110	—



B41696, B41796

Low ESR, compact – 125 °C

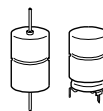

**Soldering star capacitors**

**Dimensional drawing**

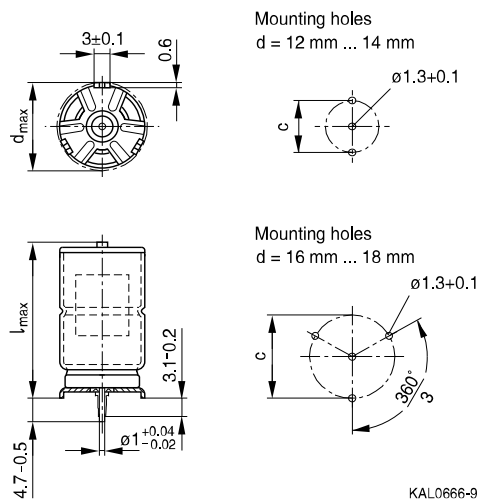

**Dimensions, weights and packing units**

d × l mm	d <sub>max</sub> × l <sub>max</sub> mm	c ±0.1 mm	Approx. weight g	Packing units pcs.
12 × 30	13.5 × 32	12.5	5.4	480
14 × 25	15.5 × 27	14.5	6.1	480
14 × 30	15.5 × 32	14.5	7.2	480
16 × 30	17.5 × 32	16.5	9.4	300
16 × 39	17.5 × 41.5	16.5	12.2	200
18 × 30	19.5 × 32	18.5	11.8	300
18 × 39	19.5 × 41.5	18.5	15.4	200

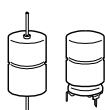

**B41696, B41796**

**Low ESR, compact – 125 °C**

**Overview of available types**

$V_R$ (V DC)	25	40
	Case dimensions d × l (mm)	
$C_R$ (μF)		
470		12 × 30
680	12 × 30	14 × 30
1000	14 × 25	16 × 30
1500	16 × 30	16 × 39 18 × 30
2200	18 × 30	18 × 39 20 × 29
3300	18 × 39 20 × 29	21 × 39
4400		21 × 49
5000	21 × 39	
6800	21 × 49	



B41696, B41796

Low ESR, compact – 125 °C

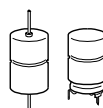

**Case dimensions and ordering codes**

$V_R$	$C_R$	Case dimensions $d \times l$ mm	Ordering code Axial pallet	Ordering code Axial reel	Ordering code Soldering star
V DC	100 Hz 20 °C $\mu F$				
25	680	12 × 30	B41696A5687Q007	B41696A5687Q009	B41796A5687Q000
	1000	14 × 25	B41696A5108Q007	B41696A5108Q009	B41796A5108Q000
	1500	16 × 30	B41696A5158Q007	B41696A5158Q009	B41796A5158Q000
	2200	18 × 30	B41696B5228Q007		B41796B5228Q000
	3300	18 × 39	B41696B5338Q007		B41796B5338Q000
	3300 ▽	20 × 29	B41696C5338Q007		
	5000	21 × 39	B41696A5508Q007		
	6800	21 × 49	B41696A5688Q007		
40	470	12 × 30	B41696A7477Q007	B41696A7477Q009	B41796A7477Q000
	680	14 × 30	B41696A7687Q007	B41696A7687Q009	B41796A7687Q000
	1000	16 × 30	B41696A7108Q007	B41696A7108Q009	B41796A7108Q000
	1500	16 × 39	B41696A7158Q007		B41796A7158Q000
	1500 ▽	18 × 30	B41696B7158Q007		B41796B7158Q000
	2200	18 × 39	B41696B7228Q007		B41796B7228Q000
	2200 ▽	20 × 29	B41696C7228Q007		
	3300	21 × 39	B41696A7338Q007		
	4400	21 × 49	B41696A7448Q007		

▽ Variant with different case dimensions

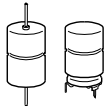

B41696, B41796

Low ESR, compact – 125 °C

Technical data

$C_R$ 100 Hz 20 °C μF	$ESR_{typ}$ 100 Hz 20 °C mΩ	$ESR_{max}$ 100 Hz 20 °C mΩ	$ESR_{max}$ 100 Hz -40 °C mΩ	$ESR_{max}$ 10 kHz 20 °C mΩ	$Z_{max}$ 100 kHz 20 °C mΩ	$I_{AC,max}$ 10 kHz 40 °C A	$I_{AC,max}$ 10 kHz 85 °C A	$I_{AC,max}$ 10 kHz 105 °C A	$I_{AC,R}$ 10 kHz 125 °C A	$I_{AC,max}$ 10 kHz 125 °C A
$V_R = 25 \text{ V DC}$										
680	95	160	1000	85	80	5.6	4.4	3.4	1.7	1.7
1000	70	115	650	65	62	5.8	4.6	3.5	1.75	1.75
1500	50	80	450	45	43	7.4	5.7	4.5	2.25	2.25
2200	32	55	300	28	27	11.0	8.7	6.7	3.4	3.4
3300	23	36	200	19	18	15.2	12.0	9.3	4.6	4.6
3300 ▽	24	38	200	22	21	12.3	9.7	7.5	3.7	3.7
5000	15	25	150	15	15	17.2	13.6	10.5	5.3	5.3
6800	12	19	110	11	11	22.0	17.4	13.5	6.7	6.7
$V_R = 40 \text{ V DC}$										
470	105	170	1000	70	68	6.0	4.7	3.6	1.8	1.8
680	80	135	600	53	51	7.1	5.6	4.3	2.2	2.2
1000	52	85	450	42	40	8.0	6.3	4.8	2.45	2.45
1500	36	58	300	29	28	11.0	8.7	6.7	3.35	3.35
1500 ▽	33	54	300	25	24	11.5	9.1	7.0	3.5	3.5
2200	23	38	200	17	16	15.7	12.4	9.6	4.8	4.8
2200 ▽	24	40	200	20	20	12.4	9.8	7.6	3.8	3.8
3300	17	27	140	14	14	17.3	13.7	10.5	5.3	5.3
4400	13	21	110	11	11	21.5	17.0	13.2	6.6	6.6

▽ Variant with different case dimensions



B41696, B41796

Low ESR, compact – 125 °C

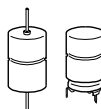

**Useful life**

depending on ambient temperature  $T_A$  under ripple current operating conditions at  $V_R^{1)}$

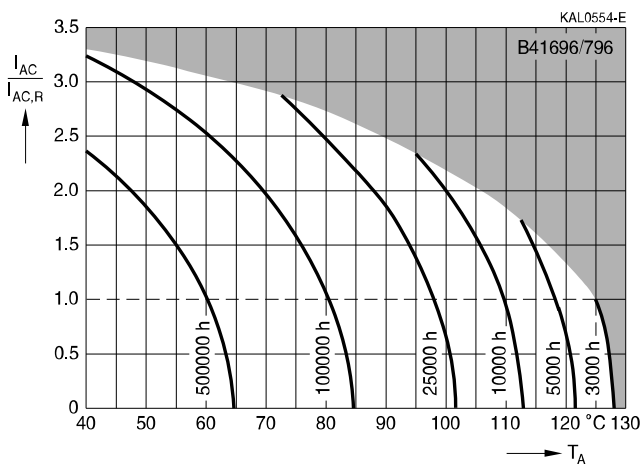

**Useful life**

depending on case temperature  $T_C$  under ripple current operating conditions at  $V_R^{1)}$

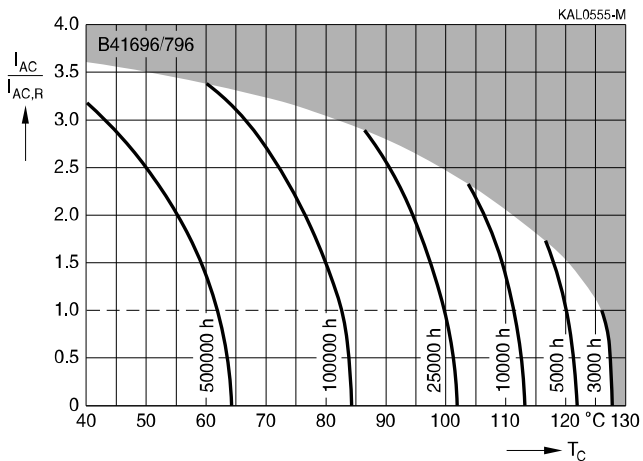

1) Refer to chapter "General technical information, 5.3 Calculation of useful life" for an explanation on how to interpret the useful life graphs.

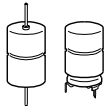

B41696, B41796

Low ESR, compact – 125 °C

**Frequency factor of permissible ripple current  $I_{AC}$  versus frequency  $f$**

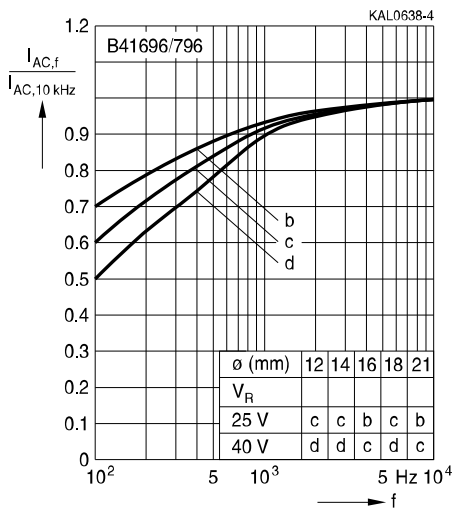

**Frequency characteristics of ESR**

Typical behavior

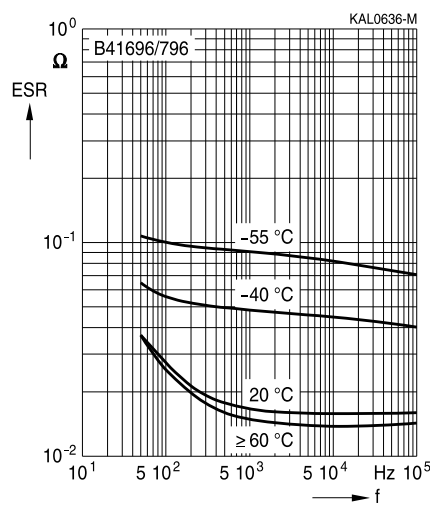

**Equivalent series resistance ESR versus frequency  $f$**

Typical behavior for 2200  $\mu$ F/40 V

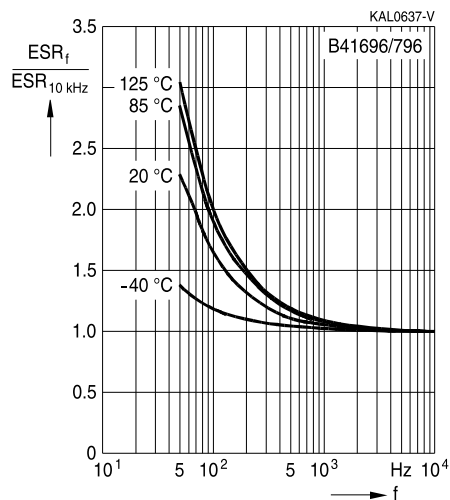

**Impedance  $Z$  versus frequency  $f$**

Typical behavior for 2200  $\mu$ F/40 V

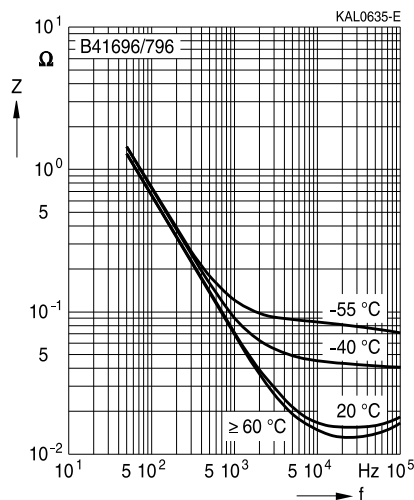



B41696, B41796

Low ESR, compact – 125 °C

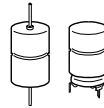

## Cautions and warnings

### Personal safety

The electrolytes used by EPCOS have not only been optimized with a view to the intended application, but also with regard to health and environmental compatibility. They do not contain any solvents that are detrimental to health, e.g. dimethyl formamide (DMF) or dimethyl acetamide (DMAC).

Furthermore, part of the high-voltage electrolytes used by EPCOS are self-extinguishing. They contain flame-retarding substances which will quickly extinguish any flame that may have been ignited.

As far as possible, EPCOS does not use any dangerous chemicals or compounds to produce operating electrolytes. However, in exceptional cases, such materials must be used in order to achieve specific physical and electrical properties because no safe substitute materials are currently known. However, the amount of dangerous materials used in our products has been limited to an absolute minimum. Nevertheless, the following rules should be observed when handling Al electrolytic capacitors:

- Any escaping electrolyte should not come into contact with eyes or skin.
- If electrolyte does come into contact with the skin, wash the affected parts immediately with running water. If the eyes are affected, rinse them for 10 minutes with plenty of water. If symptoms persist, seek medical treatment.
- Avoid breathing in electrolyte vapor or mists. Workplaces and other affected areas should be well ventilated. Clothing that has been contaminated by electrolyte must be changed and rinsed in water.

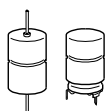

**B41696, B41796**

**Low ESR, compact – 125 °C**

**Product safety**

The table below summarize the safety instructions that must be observed without fail. A detailed description can be found in the relevant sections of chapter "General technical information".

Topic	Safety information	Reference Chapter "General technical information"
Polarity	Make sure that polar capacitors are connected with the right polarity.	1 "Basic construction of aluminum electrolytic capacitors"
Reverse voltage	Voltages polarity classes should be prevented by connecting a diode.	3.1.6 "Reverse voltage"
Upper category temperature	Do not exceed the upper category temperatur.	7.2 "Maximum permissible operating temperature"
Maintenance	Make periodic inspections of the capacitors. Before the inspection, make sure that the power supply is turned off and carefully discharge the electricity of the capacitors. Do not apply any mechanical stress to the capacitor terminals.	10 "Maintenance"
Mounting position of screw terminal capacitors	Do not mount the capacitor with the terminals (safety vent) upside down.	11.1 "Mounting positions of capacitors with screw terminals"
Mounting of single-ended capacitors	The internal structure of single-ended capacitors might be damaged if excessive force is applied to the lead wires. Avoid any compressive, tensile or flexural stress. Do not move the capacitor after soldering to PC board. Do not pick up the PC board by the soldered capacitor. Do not insert the capacitor on the PC board with a hole space different to the lead space specified.	11.4 "Mounting considerations for single-ended capacitors"
Robustness of terminals	The following maximum tightening torques must not be exceeded when connecting screw terminals: M5: 2 Nm M6: 2.5 Nm	11.3 "Mounting torques"
Soldering	Do not exceed the specified time or temperature limits during soldering.	11.5 "Soldering"



B41696, B41796

Low ESR, compact – 125 °C

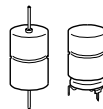

Topic	Safety information	Reference Chapter "General technical information"
Soldering, cleaning agents	Do not allow halogenated hydrocarbons to come into contact with aluminum electrolytic capacitors.	11.6 "Cleaning agents"
Passive flammability	Avoid external energy, such as fire or electricity.	8.1 "Passive flammability"
Active flammability	Avoid overload of the capacitors.	8.2 "Active flammability"
		Reference Chapter "Capacitors with screw terminals"
Breakdown strength of insulating sleeves	Do not damage the insulating sleeve, especially when ring clips are used for mounting.	"Screw terminals - accessories"

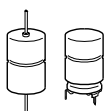

**B41696, B41796**

**Low ESR, compact – 125 °C**

Symbols and terms

Symbol	English	German
C	Capacitance	Kapazität
C <sub>R</sub>	Rated capacitance	Nennkapazität
C <sub>S</sub>	Series capacitance	Serienkapazität
C <sub>S,T</sub>	Series capacitance at temperature T	Serienkapazität bei Temperatur T
C <sub>f</sub>	Capacitance at frequency f	Kapazität bei Frequenz f
d	Case diameter, nominal dimension	Gehäusedurchmesser, Nennmaß
d <sub>max</sub>	Maximum case diameter	Maximaler Gehäusedurchmesser
ESL	Self-inductance	Eigeninduktivität
ESR	Equivalent series resistance	Ersatzserienwiderstand
ESR <sub>f</sub>	Equivalent series resistance at frequency f	Ersatzserienwiderstand bei Frequenz f
ESR <sub>T</sub>	Equivalent series resistance at temperature T	Ersatzserienwiderstand bei Temperatur T
f	Frequency	Frequenz
I	Current	Strom
I <sub>AC</sub>	Alternating current (ripple current)	Wechselstrom
I <sub>AC,rms</sub>	Root-mean-square value of alternating current	Wechselstrom, Effektivwert
I <sub>AC,f</sub>	Ripple current at frequency f	Wechselstrom bei Frequenz f
I <sub>AC,max</sub>	Maximum permissible ripple current	Maximal zulässiger Wechselstrom
I <sub>AC,R</sub>	Rated ripple current	Nennwechselstrom
I <sub>AC,R (B)</sub>	Rated ripple current for base cooling	Nennwechselstromstrom für Bodenkühlung
I <sub>leak</sub>	Leakage current	Ableitstrom
I <sub>leak,op</sub>	Operating leakage current	Ableitstrom bei Betrieb
l	Case length, nominal dimension	Gehäuselänge, Nennmaß
l <sub>max</sub>	Maximum case length (without terminals and mounting stud)	Maximale Gehäuselänge (ohne Anschlüsse und Gewindebolzen)
R	Resistance	Widerstand
R <sub>ins</sub>	Insulation resistance	Isolationswiderstand
R <sub>symm</sub>	Balancing resistance	Symmetrierwiderstand
T	Temperature	Temperatur
ΔT	Temperature difference	Temperaturdifferenz
T <sub>A</sub>	Ambient temperature	Umgebungstemperatur
T <sub>C</sub>	Case temperature	Gehäusetemperatur
T <sub>B</sub>	Capacitor base temperature	Temperatur des Becherbodens
t	Time	Zeit
Δt	Period	Zeitraum
t <sub>b</sub>	Service life (operating hours)	Brauchbarkeitsdauer (Betriebszeit)



B41696, B41796

Low ESR, compact – 125 °C

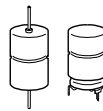

Symbol	English	German
V	Voltage	Spannung
V <sub>F</sub>	Forming voltage	Formierspannung
V <sub>op</sub>	Operating voltage	Betriebsspannung
V <sub>R</sub>	Rated voltage, DC voltage	Nennspannung, Gleichspannung
V <sub>S</sub>	Surge voltage	Spitzenspannung
X <sub>C</sub>	Capacitive reactance	Kapazitiver Blindwiderstand
X <sub>L</sub>	Inductive reactance	Induktiver Blindwiderstand
Z	Impedance	Scheinwiderstand
Z <sub>T</sub>	Impedance at temperature T	Scheinwiderstand bei Temperatur T
tan δ	Dissipation factor	Verlustfaktor
λ	Failure rate	Ausfallrate
ε <sub>0</sub>	Absolute permittivity	Elektrische Feldkonstante
ε <sub>r</sub>	Relative permittivity	Dielektrizitätszahl
ω	Angular velocity; 2 · π · f	Kreisfrequenz; 2 · π · f

**Notes**

All dimensions are given in mm.



#### Important notes

The following applies to all products named in this publication:

1. Some parts of this publication contain **statements about the suitability of our products for certain areas of application**. These statements are based on our knowledge of typical requirements that are often placed on our products in the areas of application concerned. We nevertheless expressly point out **that such statements cannot be regarded as binding statements about the suitability of our products for a particular customer application**. As a rule, EPCOS is either unfamiliar with individual customer applications or less familiar with them than the customers themselves. For these reasons, it is always ultimately incumbent on the customer to check and decide whether an EPCOS product with the properties described in the product specification is suitable for use in a particular customer application.
2. We also point out that **in individual cases, a malfunction of electronic components or failure before the end of their usual service life cannot be completely ruled out in the current state of the art, even if they are operated as specified**. In customer applications requiring a very high level of operational safety and especially in customer applications in which the malfunction or failure of an electronic component could endanger human life or health (e.g. in accident prevention or lifesaving systems), it must therefore be ensured by means of suitable design of the customer application or other action taken by the customer (e.g. installation of protective circuitry or redundancy) that no injury or damage is sustained by third parties in the event of malfunction or failure of an electronic component.
3. **The warnings, cautions and product-specific notes must be observed.**
4. In order to satisfy certain technical requirements, **some of the products described in this publication may contain substances subject to restrictions in certain jurisdictions (e.g. because they are classed as hazardous)**. Useful information on this will be found in our Material Data Sheets on the Internet ([www.epcos.com/material](http://www.epcos.com/material)). Should you have any more detailed questions, please contact our sales offices.
5. We constantly strive to improve our products. Consequently, **the products described in this publication may change from time to time**. The same is true of the corresponding product specifications. Please check therefore to what extent product descriptions and specifications contained in this publication are still applicable before or when you place an order. We also **reserve the right to discontinue production and delivery of products**. Consequently, we cannot guarantee that all products named in this publication will always be available. The aforementioned does not apply in the case of individual agreements deviating from the foregoing for customer-specific products.
6. Unless otherwise agreed in individual contracts, **all orders are subject to the current version of the "General Terms of Delivery for Products and Services in the Electrical Industry" published by the German Electrical and Electronics Industry Association (ZVEI)**.
7. The trade names EPCOS, BAOKE, Alu-X, CeraDiode, CSSP, CTVS, DSSP, MiniBlue, MKK, MLSC, MotorCap, PCC, PhaseCap, PhaseMod, SIFERRIT, SIFI, SIKOREL, SilverCap, SIMDAD, SIMID, SineFormer, SIOV, SIP5D, SIP5K, ThermoFuse, WindCap are **trademarks registered or pending** in Europe and in other countries. Further information will be found on the Internet at [www.epcos.com/trademarks](http://www.epcos.com/trademarks).

**This datasheet has been downloaded from:**

**[www.EEworld.com.cn](http://www.EEworld.com.cn)**

**Free Download**

**Daily Updated Database**

**100% Free Datasheet Search Site**

**100% Free IC Replacement Search Site**

**Convenient Electronic Dictionary**

**Fast Search System**

**[www.EEworld.com.cn](http://www.EEworld.com.cn)**