



查询"120-100-1-1-28CE"供应商

120-100

Series 74 Helical Convoluted Tubing (MIL-T-81914)
Natural or Black PFA, FEP, PTFE, Tefzel® (ETFE) or PEEK
Type A - Tubing Only - No Braid

**TYPE
A
TUBING
ONLY
NO BRAID**

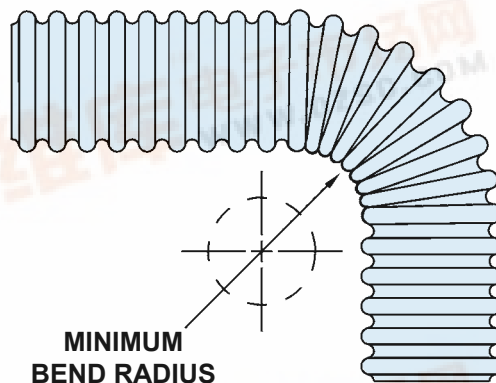
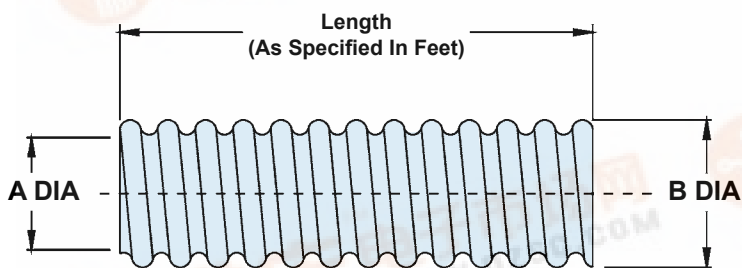
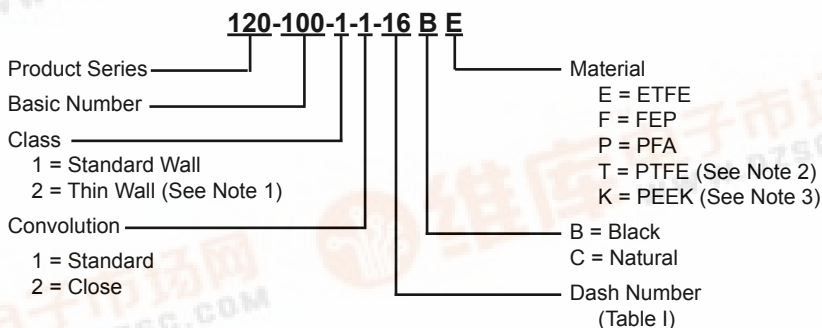

APPLICATION NOTES

1. Consult factory for thin-wall, close convolution combination.
2. Consult factory for PTFE maximum lengths.
3. Consult factory for PEEK min/max dimensions.
4. Metric dimensions (mm) are in parentheses.

TABLE I: TUBING SIZE

Dash No.	Fractional Size Ref	A Inside Dia Min	B Dia Max	Minimum Bend Radius
06	3/16	.181 (4.6)	.320 (8.1)	.500 (12.7)
09	9/32	.273 (6.9)	.414 (10.5)	.750 (19.1)
10	5/16	.306 (7.8)	.450 (11.4)	.750 (19.1)
12	3/8	.359 (9.1)	.510 (13.0)	.880 (22.4)
14	7/16	.427 (10.8)	.571 (14.5)	1.000 (25.4)
16	1/2	.480 (12.2)	.650 (16.5)	1.250 (31.8)
20	5/8	.603 (15.3)	.770 (19.6)	1.500 (38.1)
24	3/4	.725 (18.4)	.930 (23.6)	1.750 (44.5)
28	7/8	.860 (21.8)	1.073 (27.3)	1.880 (47.8)
32	1	.970 (24.6)	1.226 (31.1)	2.250 (57.2)
40	1-1/4	1.205 (30.6)	1.539 (39.1)	2.750 (69.9)
48	1-1/2	1.437 (36.5)	1.832 (46.5)	3.250 (82.6)
56	1-3/4	1.688 (42.9)	2.156 (54.8)	3.630 (92.2)
64	2	1.937 (49.2)	2.332 (59.2)	4.250 (108.0)

