

storm

700/900 SERIES
UNIVERSAL ENCODER

The universal keyboard encoder is a compact flexible encoder intended for use with the STORM 700 & 900 series keypads and keyboards from Keymat Technology Ltd and other commonly used switching technologies.

At the heart of the "STORM Universal Encoder" is an 8 bit single chip processor. Code tables and direct connections to the STORM series are provided to ensure compatibility with PC XT/AT/PS2 or ASCII RS232/423 formats.

Outputs are TTL level data and clock generating PC compatible upstroke and downstroke codes in PC mode; and TTL or RS 232/423 data in ASCII mode.

- PC XT or AT/PS2 Output format.
- ASCII Output RS232/RS423.
- Compatible with STORM sealed keypads and other commonly used switching technologies.
- Reads up to 90 key positions.
- User configurable via 8 way DIL switch.
- Single 5 Volt supply for RS423.

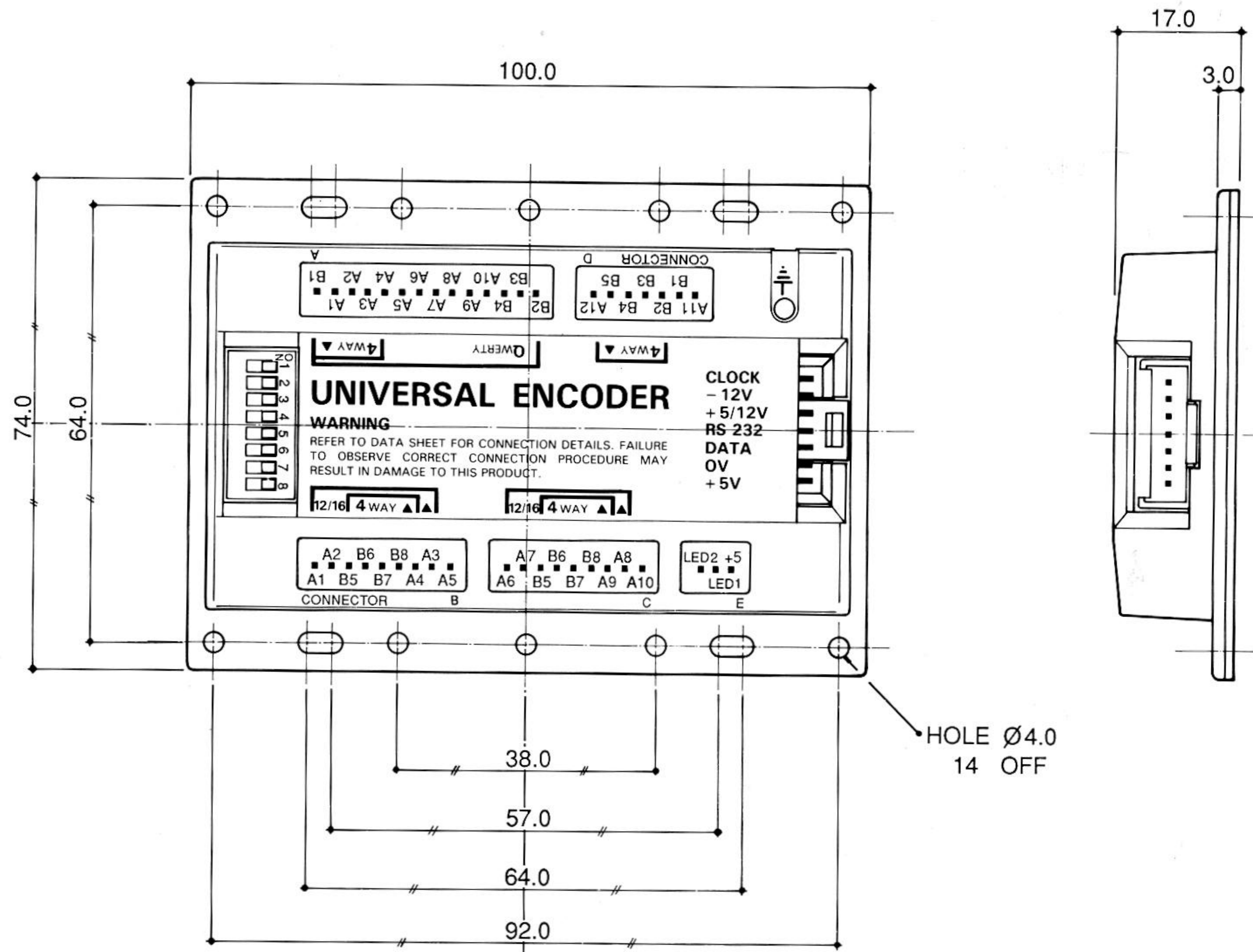

All Dimensions in mm



14 Bentinck Court Bentinck Road
West Drayton UB7 7RQ England
Telephone: 0895 431421
Telefax: 0895 431132

WHILST EVERY EFFORT IS MADE TO ENSURE DETAILS ARE CORRECT AT TIME OF PRINT, KEYMAT TECHNOLOGY LTD. CANNOT BE HELD RESPONSIBLE FOR ANY ERRORS CONTAINED WITHIN

Specifications

- | | | | |
|-----------------------|---|---------------------|---|
| Key inputs | - Maximum 90 in an 8 x 12 matrix, max 1000ohms and 20ms bounce. | Power Supply | - +5V at 130mA for PC or ASCII RS423 modes. Additional +/- 12V required for RS 232 output. |
| Serial outputs | - PC: - TTL data and clock, (ASCII) TTL and RS232/423 data. | Connectors | - Compatible with STORM 700 & 900 series keypads and keyboards.
- (0.1" pitch square pins). A mating inline discrete wire 0.1" IDC socket is supplied for power input and output connection. |
| Data format | - PC XT or AT/PS2, ASCII 7 or 8 data bit, odd, even or no parity. | | |
| Baud rate | - PC: - approx 21K Baud:
ASCII: - 1200, 2400, 4800 or 9600 Baud. | | |
| Mode Selection | - Via 8 way DIL switch. | | |

DIL Switch Settings

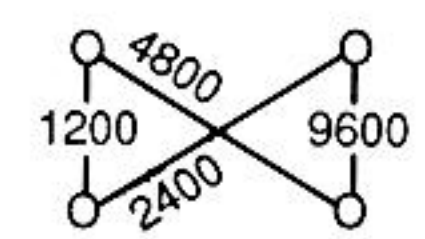
SWITCH	ON				OFF			
	FUNCTION		SWITCH		FUNCTION		SWITCH	
		ON	OFF		ON	OFF		
1.	ASC II MODE				PC MODE			
2.	PARITY ENABLE	ON	OFF	PC MODE	XT	AT/PS2		
3.	PARITY MODE	ODD	EVEN	NUM LOCK DEFAULT	ON	OFF		
4.	DATA BITS	7	8	-----	DON'T CARE			
5.	CAPS LOCK DEFAULT	ON	OFF	CAPS LOCK DEFAULT	ON	OFF		
6.	CONTROL/CAPS LOCK OPTION	CTRL	CAPS LOCK	CONTROL/CAPS LOCK OPTION	CTRL	CAPS LOCK		
7.	BAUD RATE			-----	DON'T CARE			
8.	BAUD RATE			MUST BE ON				

Input/Output Socket

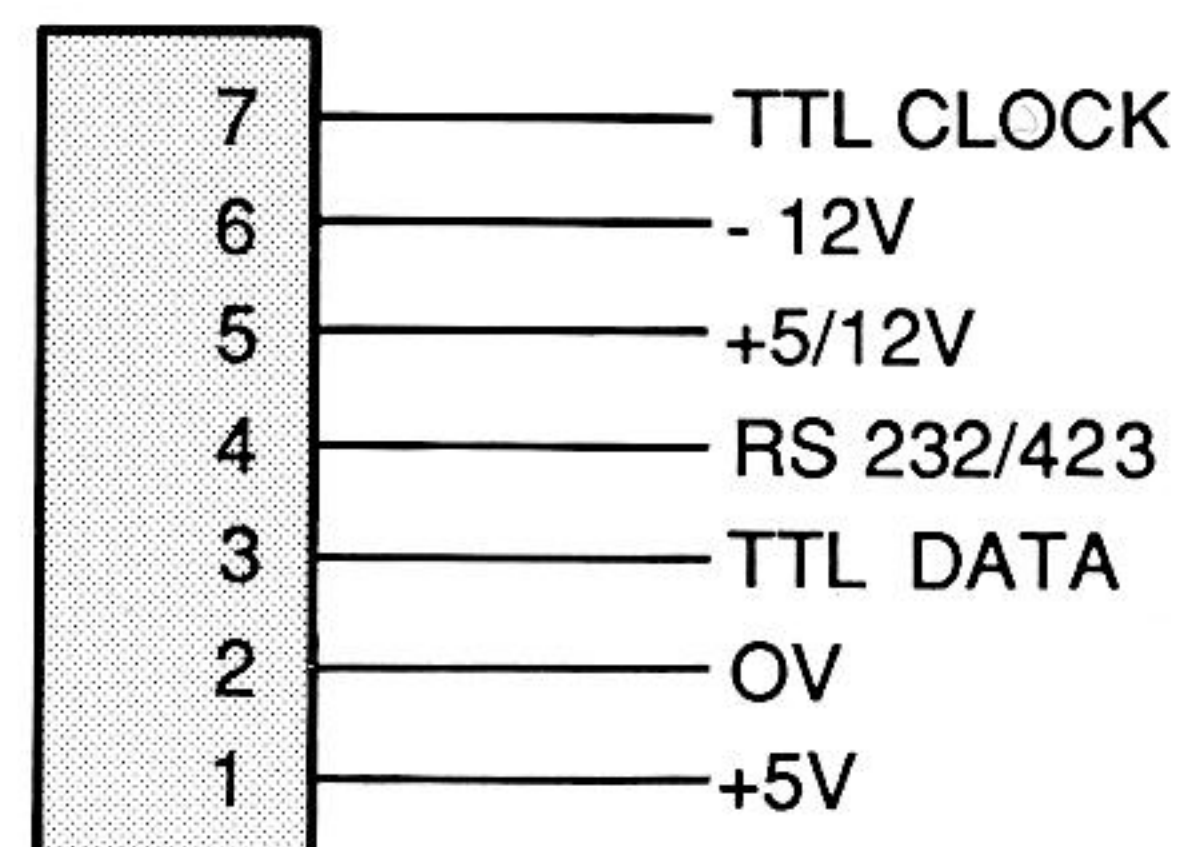

Technical Details

- Switch settings are read into processor at power up only and will have no effect if changed whilst unit is powered.
- CapsLock option SW5 and NumLock SW3 (PC only) switch default settings configure the power up state, which can be changed by subsequent operation of the appropriate key. NOTE: If the PC sets NumLock on as its default, the function of SW3 may be reversed.
- In ASCII mode RS423 (+/-5V) will be generated at Pin 4 from an internal DC/DC convertor if the +5V supply to Pin 1 is also linked to Pin 5. If the full RS232 +/-12V output is required connect +12V to Pin 5 (instead of +5V), and -12V to Pin 6, Pin 1 remains +5V.
- In PC mode only a +5V supply is required on Pin 1.
- In ASCII mode TTL data (inverted) is also available at Pin 3.
- LED drivers at connector E have 400ohm current limits from open collector TTL gates, LED1 shows CapsLock, LED2 shows Num Lock in PC mode only.
- In ASCII mode character codes greater than 7FHex have no specific function and are shown in the code tables as 'NSF'.
- When using 7 bit data mode, codes greater than 7FHex will be sent as stated code less 80Hex.
- The switch option SW6 determines function of A1/B3 as CapsLock or Control.
- Operation of keys within 2 seconds of power on may result in mode settings being read incorrectly.

PC mode

DIL Switch

Typical setting suitable for PC/XT

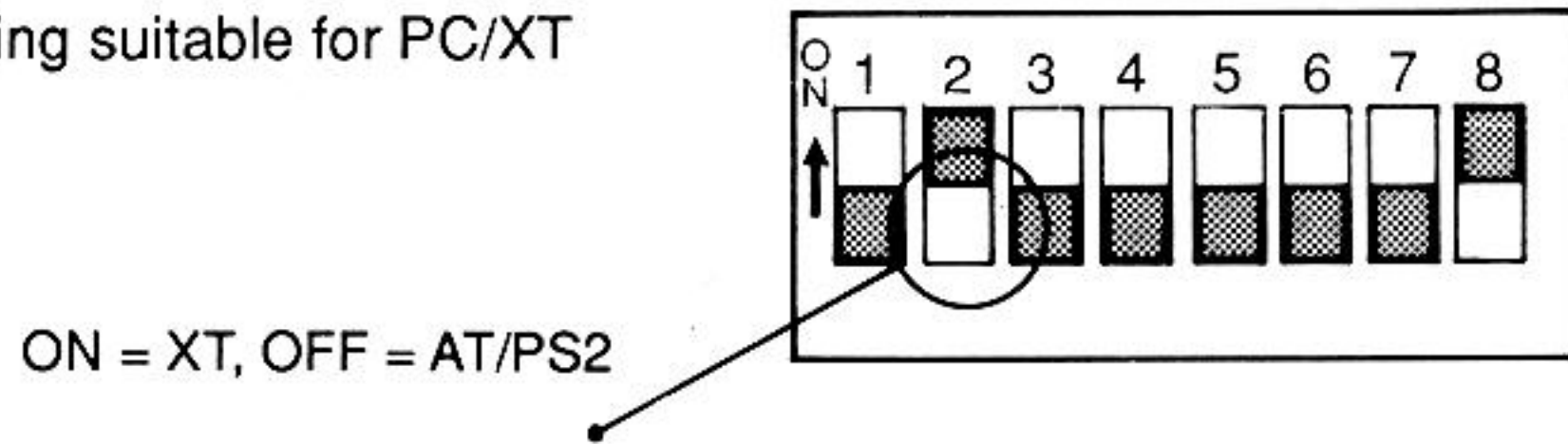

Input/Output Socket

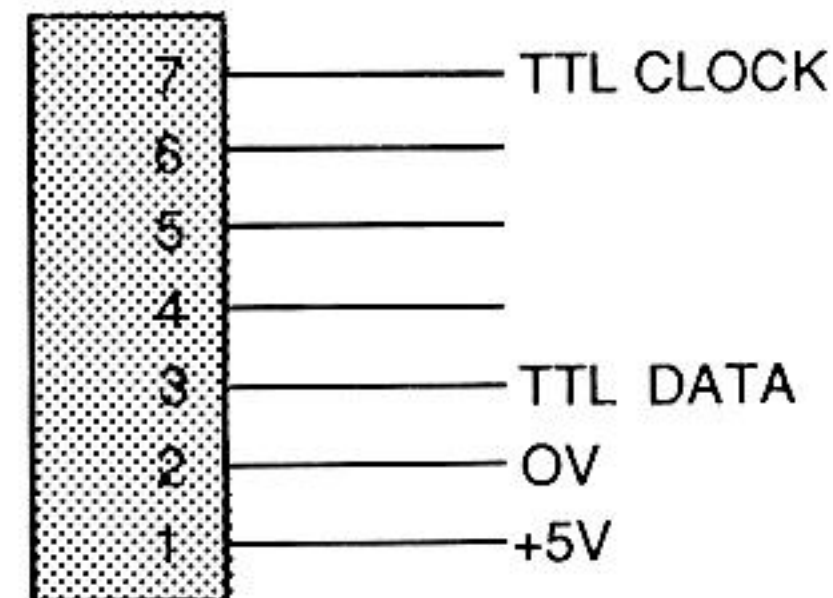

Legend Layouts

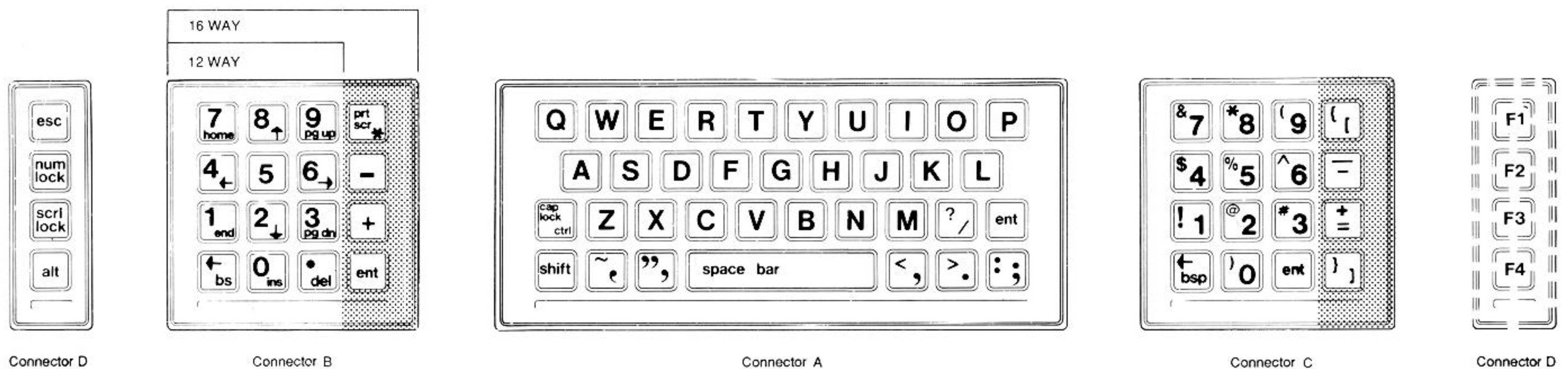

When using the Storm 700 or 900 series sealed keypads, the required legend tiles to achieve the layout as shown are available from Keymat Technology Ltd, England, or their appointed distributors.

If F1, F2, F3, F4 are required, the 4 way keypad should be connected to encoder connector D, connections designated A11 (common), B1, B2 and B4.

Keycode Table PC XT and AT/PS2 mode

All codes are Hex; A1/B1 etc refers to A/B matrix designations. Refer to pin ident on the device for correct matrix connections. Code Table layout corresponds with legend layouts as shown above.

eg. Key at A1/B1
10 = XT downcode, upcode = downcode + 80 Hex
15 = AT/PS2 downcode, upcode = FO Hex and downcode
Qq = normal key function (defined by boot disc)

Connector B	B8	B7	B6	B5
A5	01 76 ESC	45 77 NUML	46 7E SCRL	54 84 SYRQ
A3	47 6C 7	48 75 8	49 7D 9	37 7C Pr*
A4	4B 6B 4	4C 73 5	4D 74 6	4A 7B -
A1	4F 69 1	50 72 2	51 7A 3	4E 79 +
A2	0E 66 BSP	52 70 0	53 71 DEL	1C 5A ENT

Connector A	A1	A2	A3	A4	A5	A6	A7	A8	A9	A10
B1	10 15 Qq	11 1D Ww	12 24 Ee	13 2D Rr	14 2C Tt	15 35 Yy	16 3C Uu	17 43 Ii	18 44 Oo	19 4D Pp
B2	1E 1C Aa	1F 1B Ss	20 23 Dd	21 2B Ff	22 34 Gg	23 33 Hh	24 3B Jj	25 42 Kk	26 4B Ll	2B 5D I \
B3	1D/3A 14/5B	2C 1A	2D 22	2E 21	2F 2A	30 32	31 31	35 3A	33 4A	1C 5A
B4	2A 12 SFT	29 0E ~,	28 52 ...	39 29 SPC	0F 0D TAB	38 11 ALT	1D 14 CTL	33 41 <, >	34 49 >, <	27 4C ::

Connector C	B8	B7	B6	B5
A10	2A 12 SFT	3A 5B CPL	0F 0D TAB	1D 14 CTRL
A8	08 3D &7	09 3E *8	0A 46 (9	1A 54 {[
A9	05 25 \$4	06 2E %5	07 36 ^6	0C 4E _
A6	02 16 !1	03 1E @2	04 26 #3	0D 55 +=
A7	0E 66 BSP	0B 45)0	1C 5A ENT	1B 5B }]

Connector D	A11	A12
B1	3E 0C F4	37 7C PrSc
B2	3D 04 F3	01 76 ESC
B3	3C 06 F2	45 77 NUM LOCK
B4	3B 05 F1	46 7E SCRL LOCK
B5	3F 03 F5	38 11 ALT

Note: Code Tables may be subject to change - please refer to Keymat Technology Ltd

ASCII mode

DIL Switch

Typical ASCII mode;
no parity, 8 data bits, 1200 Baud.

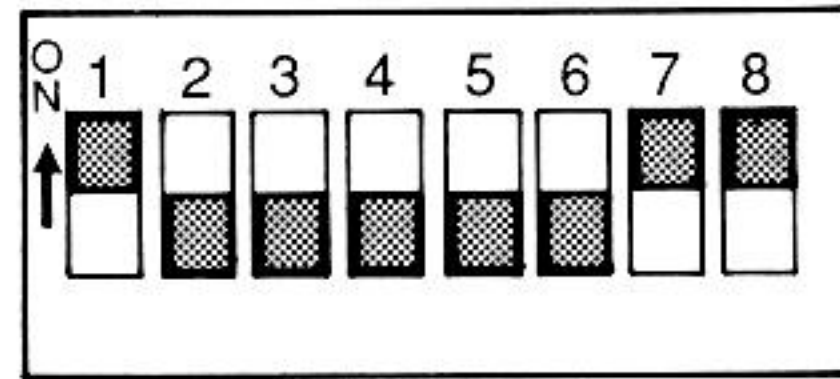

Input/Output Socket

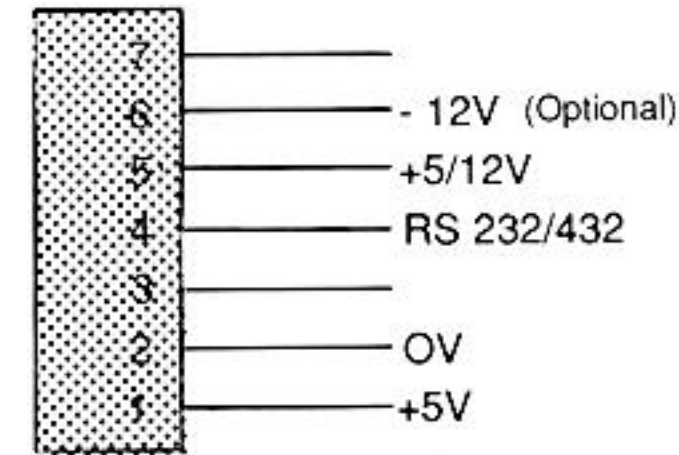

Legend Layouts

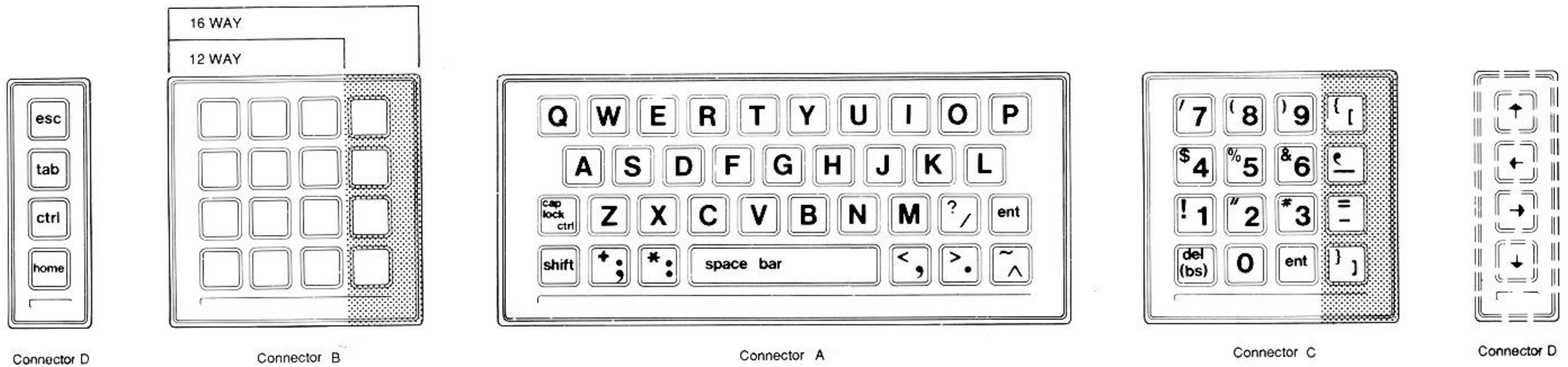

When using the Storm 700 or 900 series sealed keypads, the required legend tiles to achieve the layout as shown are available from Keymat Technology Ltd, England, or their appointed distributors.

If cursor control keys are required, the 4 way keypad should be connected to encoder connector D, connections designated A11 (common), B1, B2, and B4.

Keycode Table ASCII mode

All codes are Hex; A1/B1 etc refers to A/B matrix designations. Refer to pin ident on the device for correct matrix connections. Code Table layout corresponds with legend layouts as shown above.

eg. Key at A1/B1
51 = upper case code
71 = lower case code
11 = + CTRL code
Qq = normal ASCII function, NSF = no specific function.

Connector B		B8	B7	B6	B5
A5	D0	D1	D2	D3	D3
	B0	B1	B2	B3	B3
	F0	F1	F2	F3	F3
	NSF	NSF	NSF	NSF	NSF
A3	C0	C1	C2	C3	C3
	A0	A1	A2	A3	A3
	E0	E1	E2	E3	E3
	NSF	NSF	NSF	NSF	NSF
A4	C4	C5	C6	C7	C7
	A4	A5	A6	A7	A7
	E4	E5	E6	E7	E7
	NSF	NSF	NSF	NSF	NSF
A1	C8	C9	CA	CB	CB
	A8	A9	AA	AB	AB
	E8	E9	EA	EB	EB
	NSF	NSF	NSF	NSF	NSF
A2	CC	CD	CE	CF	CF
	AC	AD	AE	AF	AF
	EC	ED	EE	DF	DF
	NSF	NSF	NSF	NSF	NSF

Connector A		A1	A2	A3	A4	A5	A6	A7	A8	A9	A10
B1	51	57	45	52	54	59	55	49	4F	50	50
	71	77	65	72	74	79	75	69	6F	70	70
	11	17	05	12	14	19	15	09	0F	10	10
	Qq	Ww	Ee	Rr	Tt	Yy	Uu	li	Oo	Pp	Pp
B2	41	53	44	46	47	48	4A	4B	4C	7C	7C
	61	73	64	66	67	68	6A	6B	6C	5C	5C
	01	13	04	06	07	08	0A	0B	0C	1C	1C
	Aa	Ss	Dd	Ff	Gg	Hh	Jj	Kk	Ll	I\	I\
B3	CTRL	5A	58	43	56	42	4E	4D	3F	OD	OD
	or	7A	78	63	76	62	6E	6D	2F	OD	OD
	CAPL	1A	18	03	16	02	0E	0D	2F	OD	OD
		Zz	Xx	Cc	Vv	Bb	Nn	Mm	?/	RET	RET
B4	SFT	2B	2A	20	09	40	CTRL	3C	3E	7E	7E
		3B	3A	20	09	40	CTRL	2C	2E	5E	5E
		3B	3A	20	09	00	CTRL	2C	2E	1E	1E
		+.:	*.;	SPC	TAB	@	CTRL	<, >	>.	~^	~^

Connector C		B8	B7	B6	B5
A10	D4	D5	D6	D7	D7
	B4	B5	B6	B7	B7
	F4	F5	F6	F7	F7
	NSF	NSF	NSF	NSF	NSF
A8	27	28	29	7B	7B
	37	38	39	5B	5B
	37	38	39	1B	1B
	7	(8)9	{	{
A9	24	25	26	60	60
	34	35	36	5F	5F
	34	35	36	1F	1F
	\$4	%5	&6	€	€
A6	21	22	23	3D	3D
	31	32	33	2D	2D
	31	32	33	2D	2D
	!1	"2	#3	=	=
A7	7F	30	0D	7D	7D
	7F	30	0D	5D	5D
	7F	30	0D	1D	1D
	DEL	0	ENT	}}	}}

Connector D		A11	A12
B1	0A	D9	D9
	0A	B9	B9
	0A	F9	F9
	LF	NSF	NSF
B2	09	1B	1B
	09	1B	1B
	09	1B	1B
	HT	ESC	ESC
B3	08	09	09
	08	09	09
	08	09	09
	B5	TAB	TAB
B4	0B	CTRL	CTRL
	0B	CTRL	CTRL
	0B	CTRL	CTRL
	VT	CTRL	CTRL
B5	D8	1E	1E
	B8	1E	1E
	F8	1E	1E
	NSF	HOME	HOME

Note: Code Tables may be subject to change – please refer to Keymat Technology Ltd