

DATA SHEET

BF1100; BF1100R Dual-gate MOS-FETs

Product specification
File under Discrete Semiconductors, SC07

1995 Apr 25

Philips Semiconductors



PHILIPS

Dual-gate MOS-FETs

BF1100; BF1100R

FEATURES

- Specially designed for use at 9 to 12 V supply voltage
- Short channel transistor with high forward transfer admittance to input capacitance ratio
- Low noise gain controlled amplifier up to 1 GHz
- Superior cross-modulation performance during AGC.

APPLICATIONS

- VHF and UHF applications such as television tuners and professional communications equipment.

DESCRIPTION

Enhancement type field-effect transistor in a plastic microminiature SOT143 or SOT143R package. The transistor consists of an amplifier MOS-FET with source

and substrate interconnected and an internal bias circuit to ensure good cross-modulation performance during AGC.

CAUTION

The device is supplied in an antistatic package. The gate-source input must be protected against static discharge during transport or handling.

PINNING

| PIN | SYMBOL | DESCRIPTION |
|-----|----------------|-------------|
| 1 | s, b | source |
| 2 | d | drain |
| 3 | g ₂ | gate 2 |
| 4 | g ₁ | gate 1 |

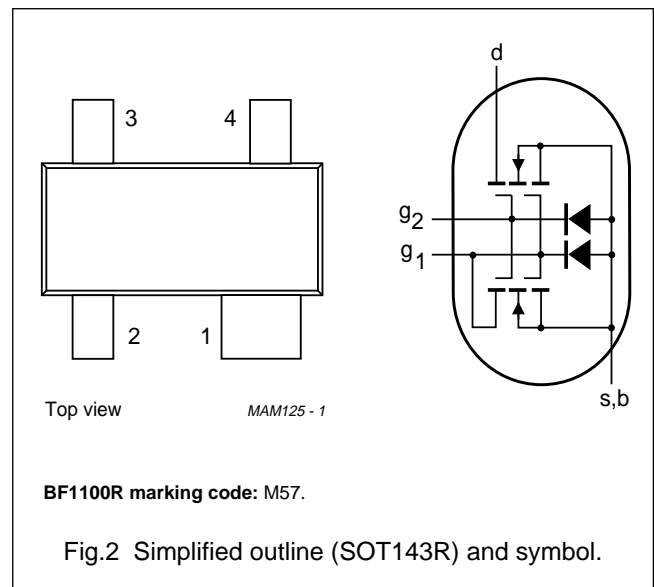
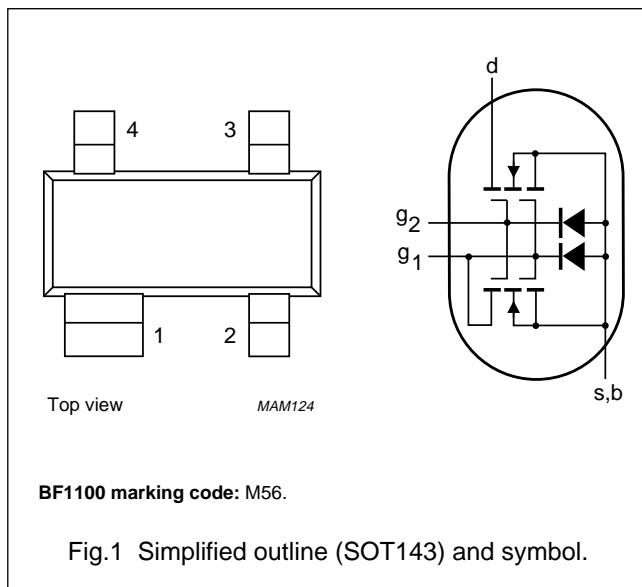

QUICK REFERENCE DATA

| SYMBOL | PARAMETER | CONDITIONS | MIN. | TYP. | MAX. | UNIT |
|--------------------|--------------------------------|-------------|------|------|------|------|
| V _{DS} | drain-source voltage | | – | – | 14 | V |
| I _D | drain current | | – | – | 30 | mA |
| P _{tot} | total power dissipation | | – | – | 200 | mW |
| T _j | operating junction temperature | | – | – | 150 | °C |
| y _{fs} | forward transfer admittance | | 24 | 28 | 33 | mS |
| C _{ig1-s} | input capacitance at gate 1 | | – | 2.2 | 2.6 | pF |
| C _{rs} | reverse transfer capacitance | f = 1 MHz | – | 25 | 35 | fF |
| F | noise figure | f = 800 MHz | – | 2 | – | dB |

Dual-gate MOS-FETs

BF1100; BF1100R

LIMITING VALUES

In accordance with the Absolute Maximum Rating System (IEC 134).

| SYMBOL | PARAMETER | CONDITIONS | MIN. | MAX. | UNIT |
|-----------|--|---|------|------------|------------------|
| V_{DS} | drain-source voltage | | – | 14 | V |
| I_D | drain current | | – | 30 | mA |
| I_{G1} | gate 1 current | | – | ± 10 | mA |
| I_{G2} | gate 2 current | | – | ± 10 | mA |
| P_{tot} | total power dissipation BF1100 BF1100R | see Fig.3 up to $T_{amb} = 50\text{ }^\circ\text{C}$; note 1 up to $T_{amb} = 40\text{ }^\circ\text{C}$; note 1 | – | 200 200 | mW mW |
| T_{stg} | storage temperature | | –65 | +150 | $^\circ\text{C}$ |
| T_j | operating junction temperature | | – | +150 | $^\circ\text{C}$ |

Note

1. Device mounted on a printed-circuit board.

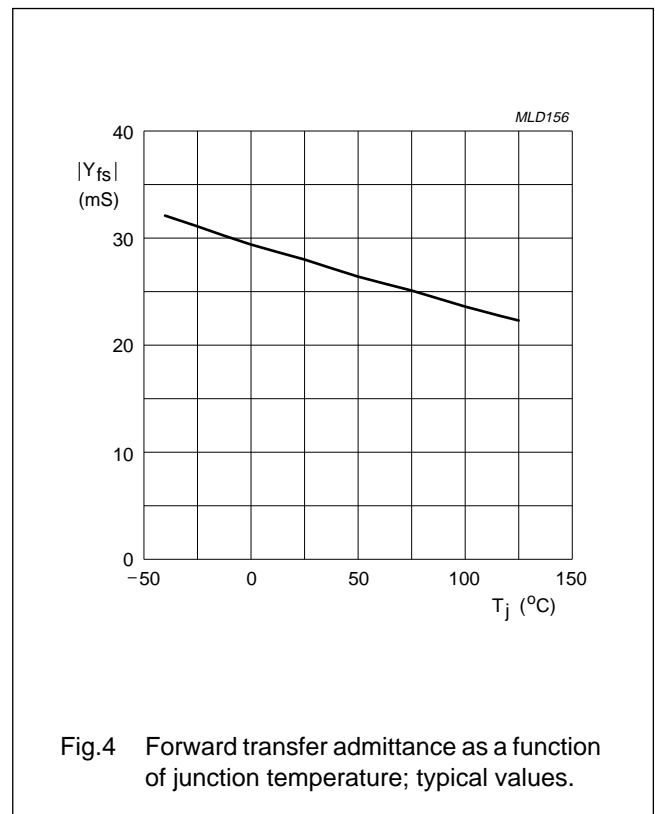
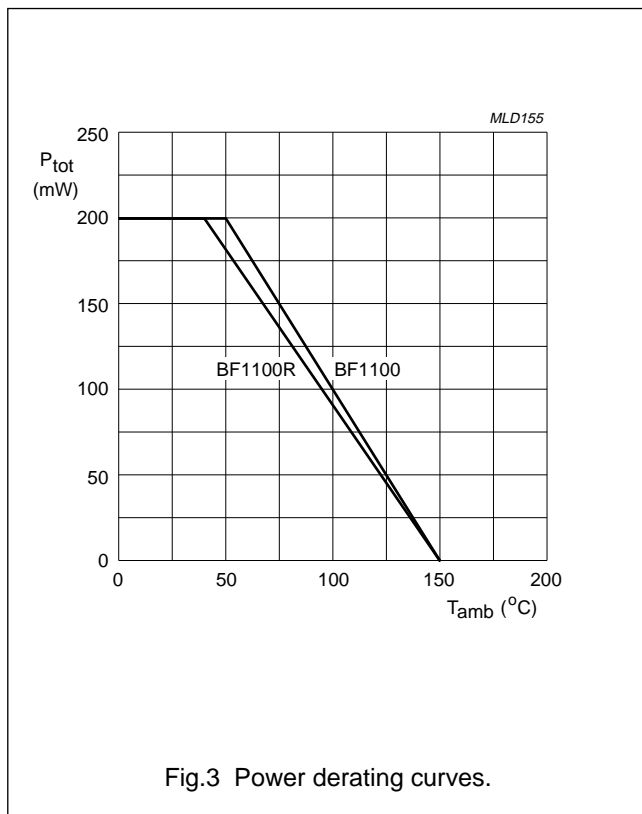

Dual-gate MOS-FETs

BF1100; BF1100R

THERMAL CHARACTERISTICS

| SYMBOL | PARAMETER | CONDITIONS | VALUE | UNIT | |
|---------------|---|------------|----------------------|------|-----|
| $R_{th\ j-a}$ | thermal resistance from junction to ambient | note 1 | | | |
| | BF1100 | | 500 | K/W | |
| | BF1100R | | 550 | K/W | |
| $R_{th\ j-s}$ | thermal resistance from junction to soldering point | note 2 | | | |
| | BF1100 | | $T_s = 92\text{ °C}$ | 290 | K/W |
| | BF1100R | | $T_s = 78\text{ °C}$ | 360 | K/W |

Notes

1. Device mounted on a printed-circuit board.
2. T_s is the temperature at the soldering point of the source lead.

STATIC CHARACTERISTICS

$T_j = 25\text{ °C}$; unless otherwise specified.

| SYMBOL | PARAMETER | CONDITIONS | MIN. | MAX. | UNIT |
|-----------------|---------------------------------|--|------|------|------|
| $V_{(BR)G1-SS}$ | gate 1-source breakdown voltage | $V_{G2-S} = V_{DS} = 0$; $I_{G1-S} = 1\text{ mA}$ | 13.2 | 20 | V |
| $V_{(BR)G2-SS}$ | gate 2-source breakdown voltage | $V_{G1-S} = V_{DS} = 0$; $I_{G2-S} = 1\text{ mA}$ | 13.2 | 20 | V |
| $V_{(F)S-G1}$ | forward source-gate 1 voltage | $V_{G2-S} = V_{DS} = 0$; $I_{S-G1} = 10\text{ mA}$ | 0.5 | 1.5 | V |
| $V_{(F)S-G2}$ | forward source-gate 2 voltage | $V_{G1-S} = V_{DS} = 0$; $I_{S-G2} = 10\text{ mA}$ | 0.5 | 1.5 | V |
| $V_{G1-S(th)}$ | gate 1-source threshold voltage | $V_{G2-S} = 4\text{ V}$; $V_{DS} = 9\text{ V}$; $I_D = 20\text{ }\mu\text{A}$ | 0.3 | 1 | V |
| | | $V_{G2-S} = 4\text{ V}$; $V_{DS} = 12\text{ V}$; $I_D = 20\text{ }\mu\text{A}$ | 0.3 | 1 | V |
| $V_{G2-S(th)}$ | gate 2-source threshold voltage | $V_{G1-S} = 4\text{ V}$; $V_{DS} = 9\text{ V}$; $I_D = 20\text{ }\mu\text{A}$ | 0.3 | 1.2 | V |
| | | $V_{G1-S} = 4\text{ V}$; $V_{DS} = 12\text{ V}$; $I_D = 20\text{ }\mu\text{A}$ | 0.3 | 1.2 | V |
| I_{DSX} | drain-source current | $V_{G2-S} = 4\text{ V}$; $V_{DS} = 9\text{ V}$; $R_{G1} = 180\text{ k}\Omega$; note 1 | 8 | 13 | mA |
| | | $V_{G2-S} = 4\text{ V}$; $V_{DS} = 12\text{ V}$; $R_{G1} = 250\text{ k}\Omega$; note 2 | 8 | 13 | mA |
| I_{G1-SS} | gate 1 cut-off current | $V_{G2-S} = V_{DS} = 0$; $V_{G1-S} = 12\text{ V}$ | – | 50 | nA |
| I_{G2-SS} | gate 2 cut-off current | $V_{G1-S} = V_{DS} = 0$; $V_{G2-S} = 12\text{ V}$ | – | 50 | nA |

Notes

1. R_{G1} connects gate 1 to $V_{GG} = 9\text{ V}$; see Fig.27.
2. R_{G1} connects gate 1 to $V_{GG} = 12\text{ V}$; see Fig.27.

Dual-gate MOS-FETs

BF1100; BF1100R

DYNAMIC CHARACTERISTICS

Common source; $T_{amb} = 25\text{ }^\circ\text{C}$; $V_{G2-S} = 4\text{ V}$; $I_D = 10\text{ mA}$; unless otherwise specified.

| SYMBOL | PARAMETER | CONDITIONS | MIN. | TYP. | MAX. | UNIT |
|-------------|------------------------------|---|------|------|------|------|
| $ y_{fs} $ | forward transfer admittance | pulsed; $T_j = 25\text{ }^\circ\text{C}$ $V_{DS} = 9\text{ V}$ | 24 | 28 | 33 | mS |
| | | $V_{DS} = 12\text{ V}$ | 24 | 28 | 33 | mS |
| C_{ig1-s} | input capacitance at gate 1 | $f = 1\text{ MHz}$ $V_{DS} = 9\text{ V}$ | – | 2.2 | 2.6 | pF |
| | | $V_{DS} = 12\text{ V}$ | – | 2.2 | 2.6 | pF |
| C_{ig2-s} | input capacitance at gate 2 | $f = 1\text{ MHz}$ $V_{DS} = 9\text{ V}$ | – | 1.6 | – | pF |
| | | $V_{DS} = 12\text{ V}$ | – | 1.4 | – | pF |
| C_{os} | drain-source capacitance | $f = 1\text{ MHz}$ $V_{DS} = 9\text{ V}$ | – | 1.4 | 1.8 | pF |
| | | $V_{DS} = 12\text{ V}$ | – | 1.1 | 1.5 | pF |
| C_{rs} | reverse transfer capacitance | $f = 1\text{ MHz}$ $V_{DS} = 9\text{ V}$ | – | 25 | 35 | fF |
| | | $V_{DS} = 12\text{ V}$ | – | 25 | 35 | fF |
| F | noise figure | $f = 800\text{ MHz}$; $G_S = G_{Sopt}$; $B_S = B_{Sopt}$ $V_{DS} = 9\text{ V}$ | – | 2 | 2.8 | dB |
| | | $V_{DS} = 12\text{ V}$ | – | 2 | 2.8 | dB |

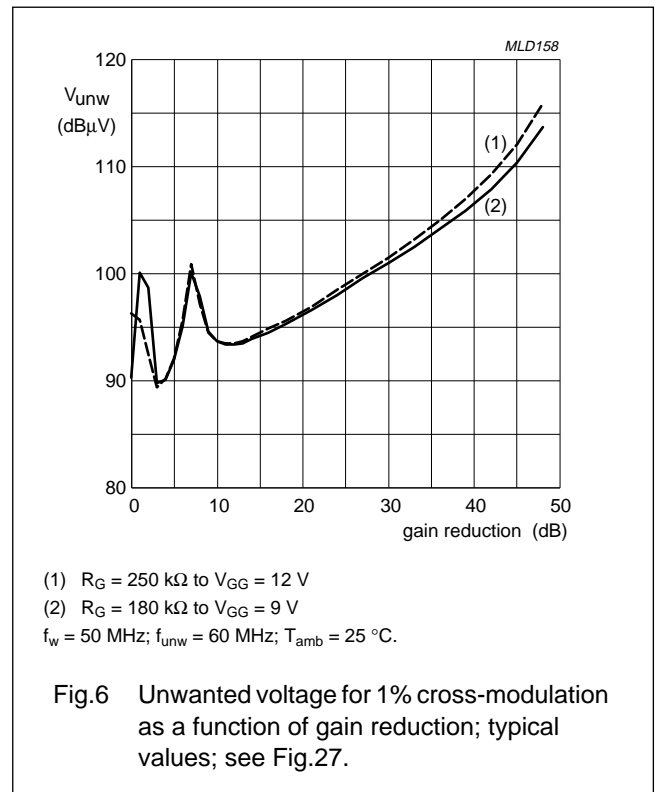
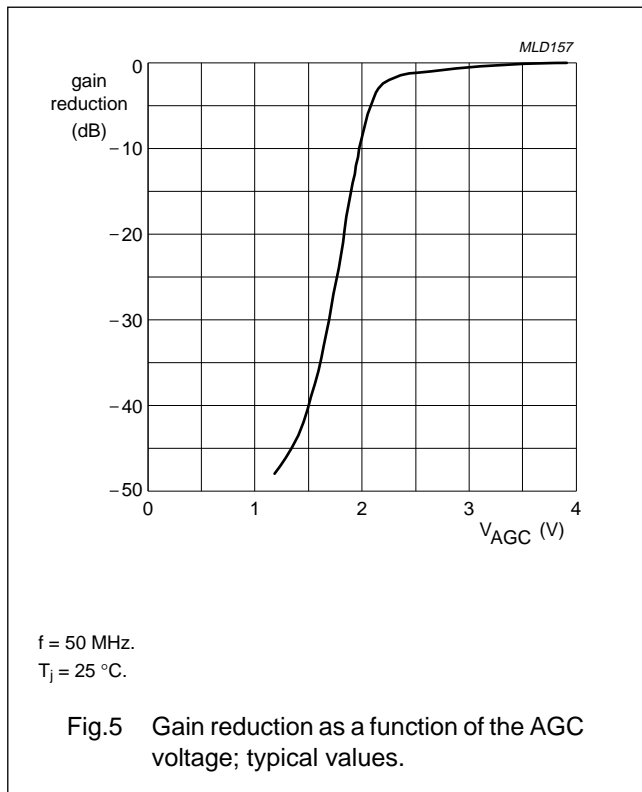

Dual-gate MOS-FETs

BF1100; BF1100R

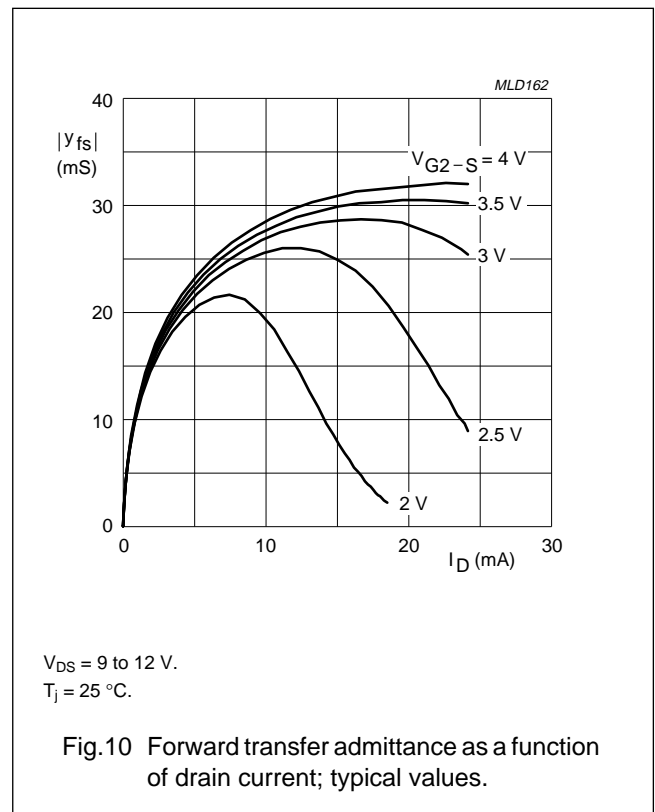
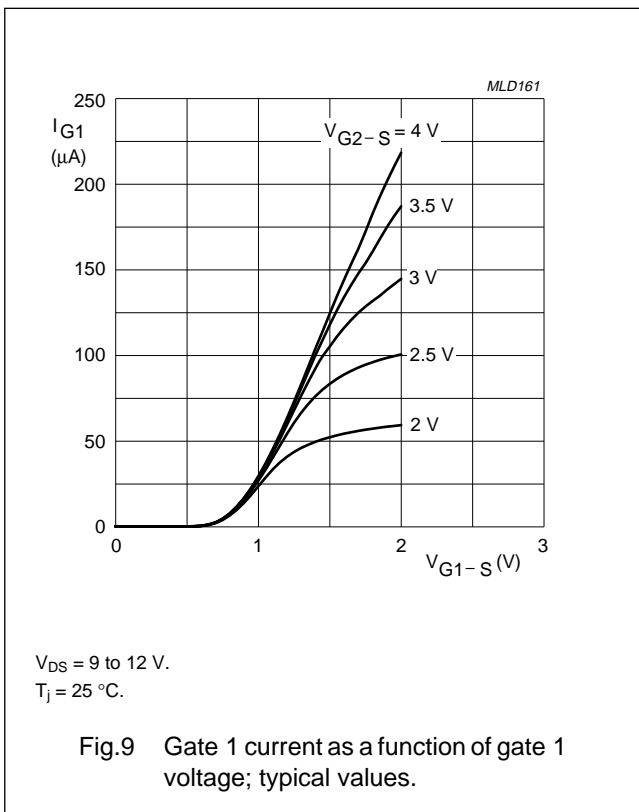
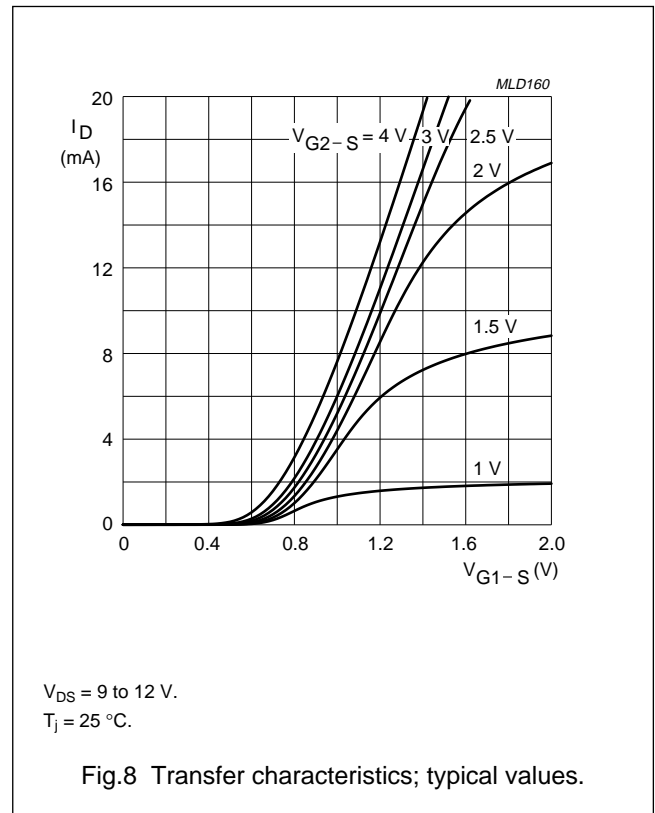
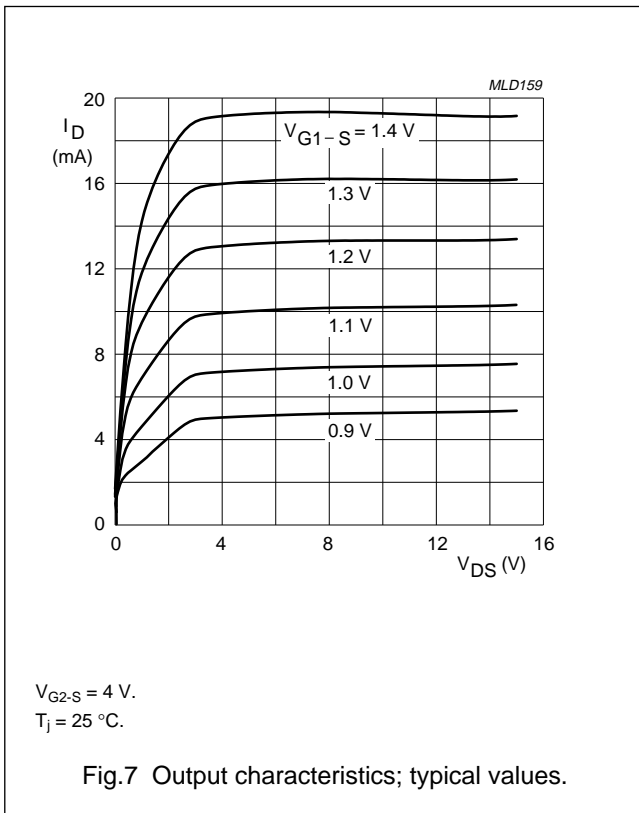

Dual-gate MOS-FETs

BF1100; BF1100R

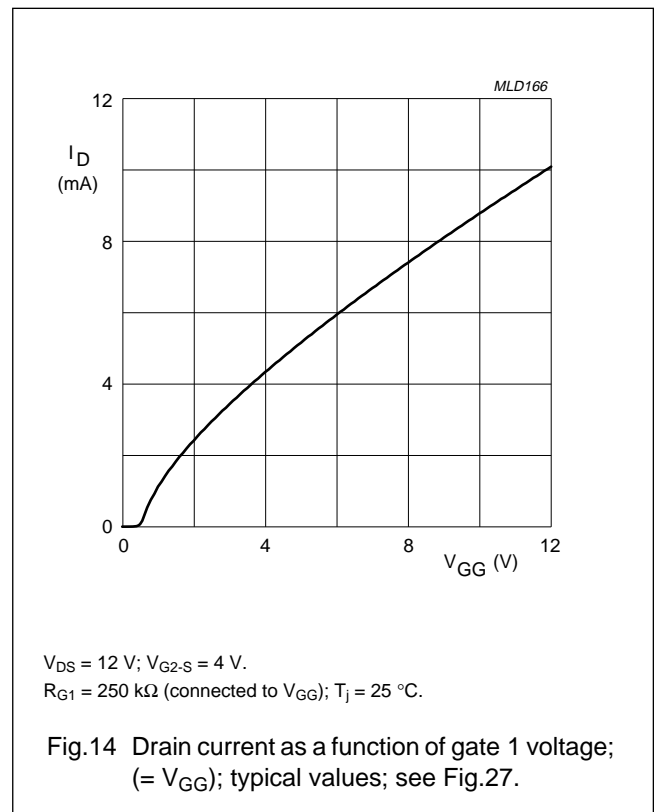
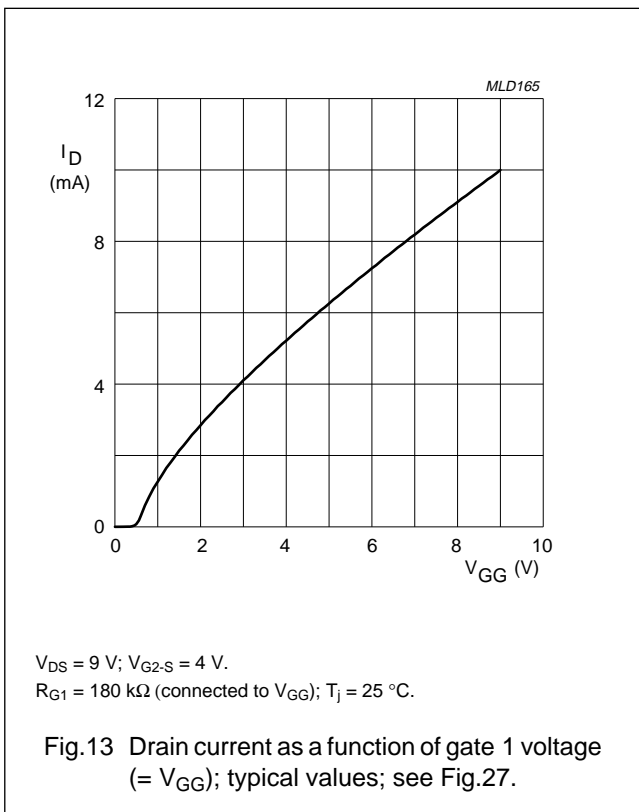
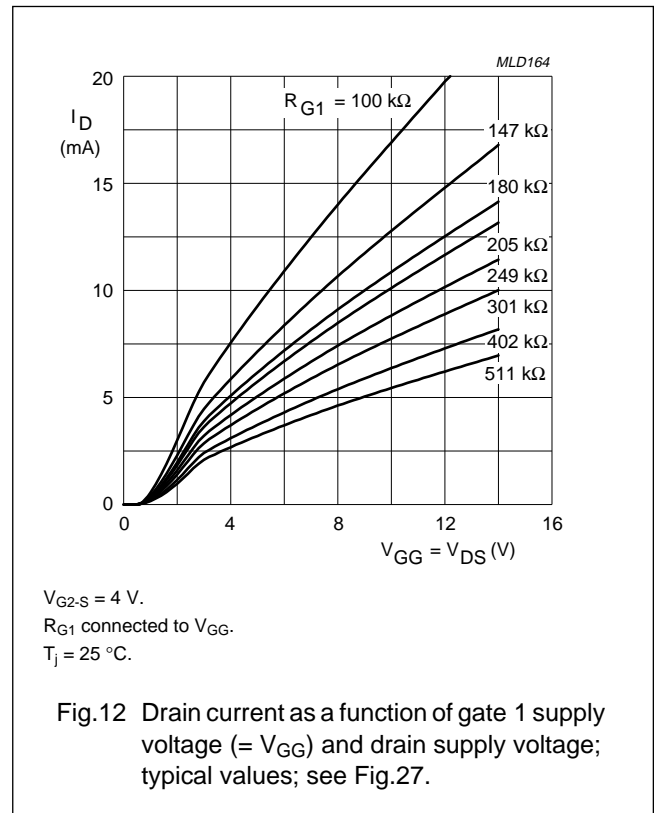
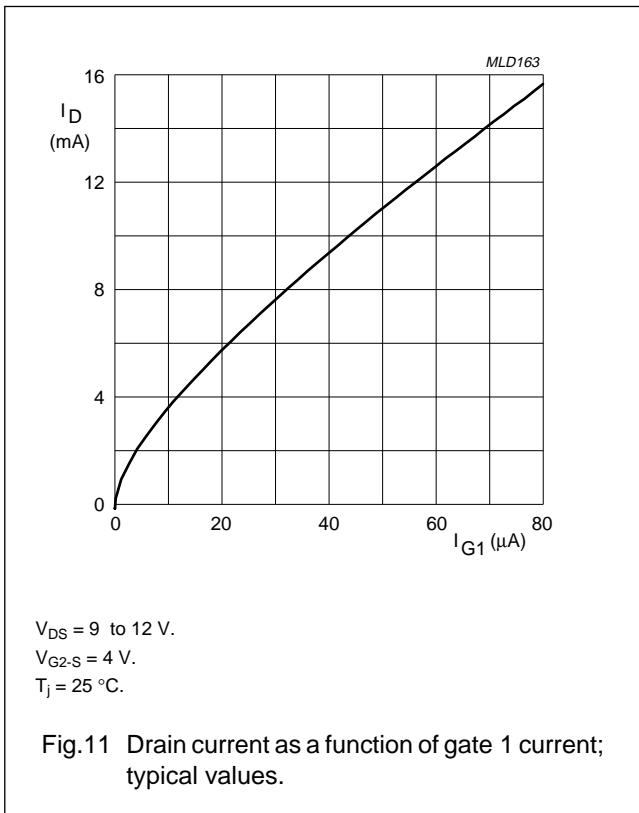

Dual-gate MOS-FETs

BF1100; BF1100R

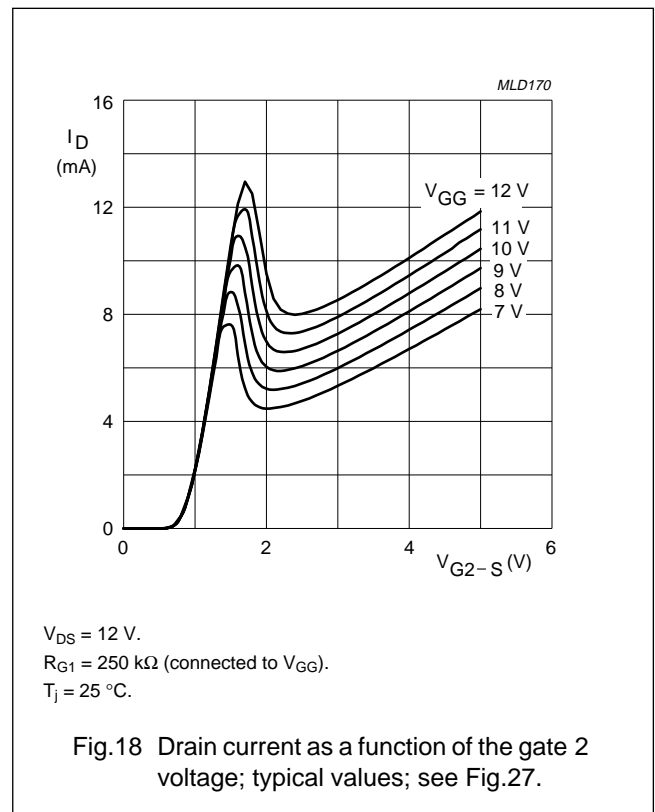
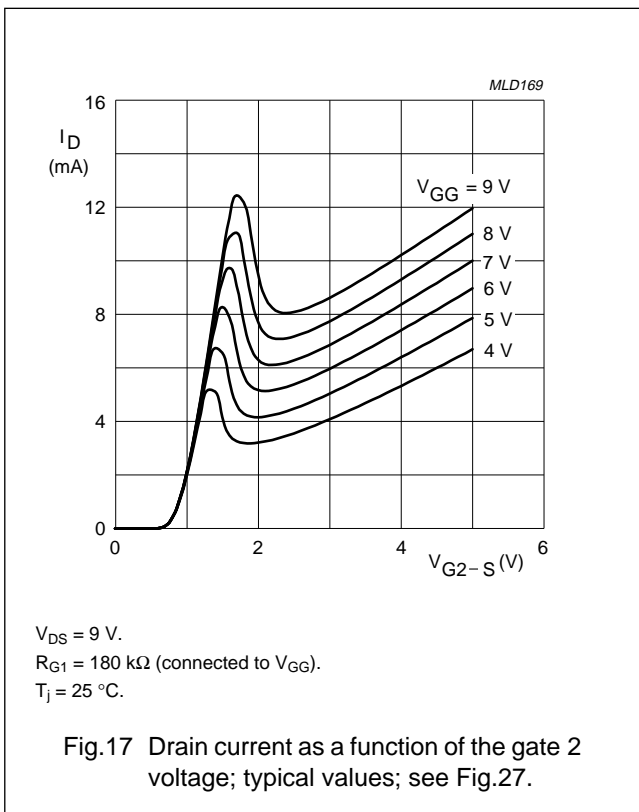
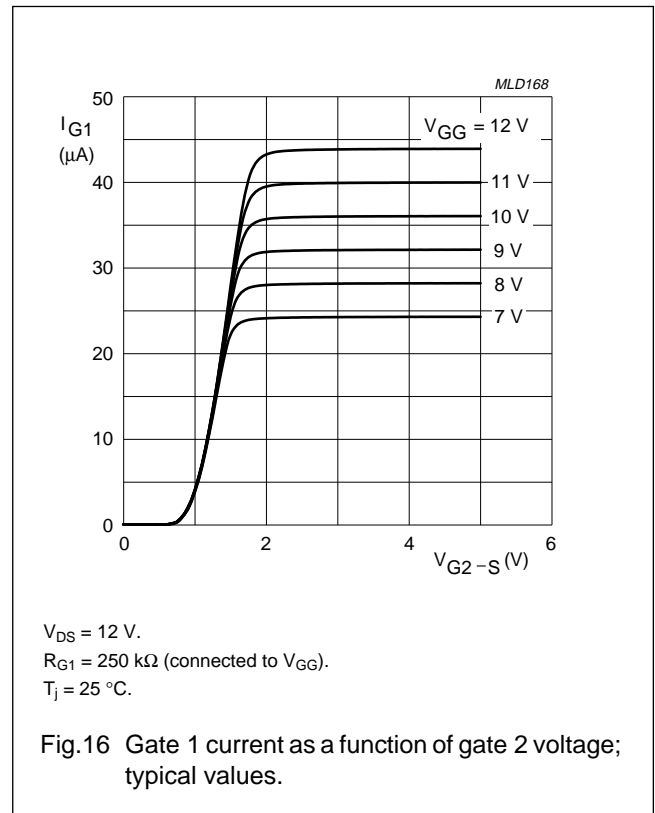
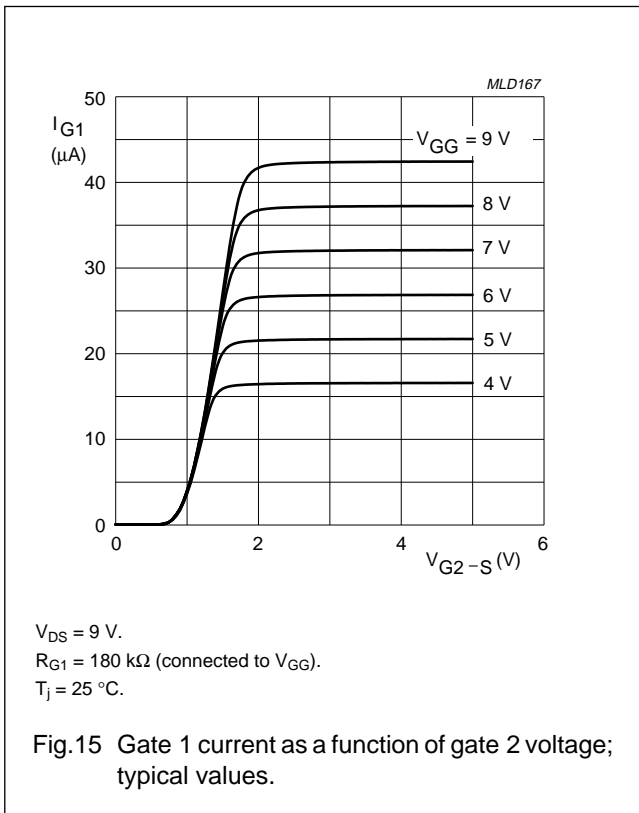

Dual-gate MOS-FETs

BF1100; BF1100R

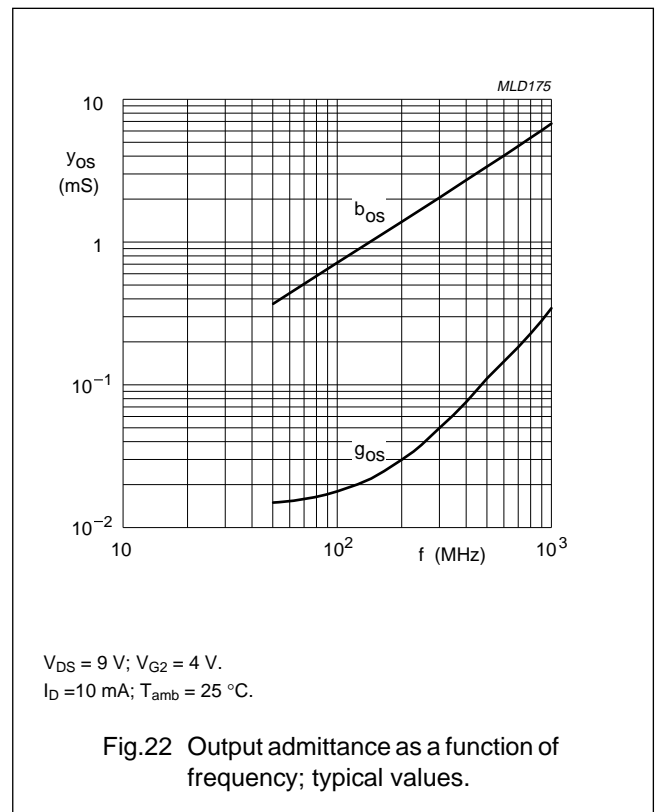
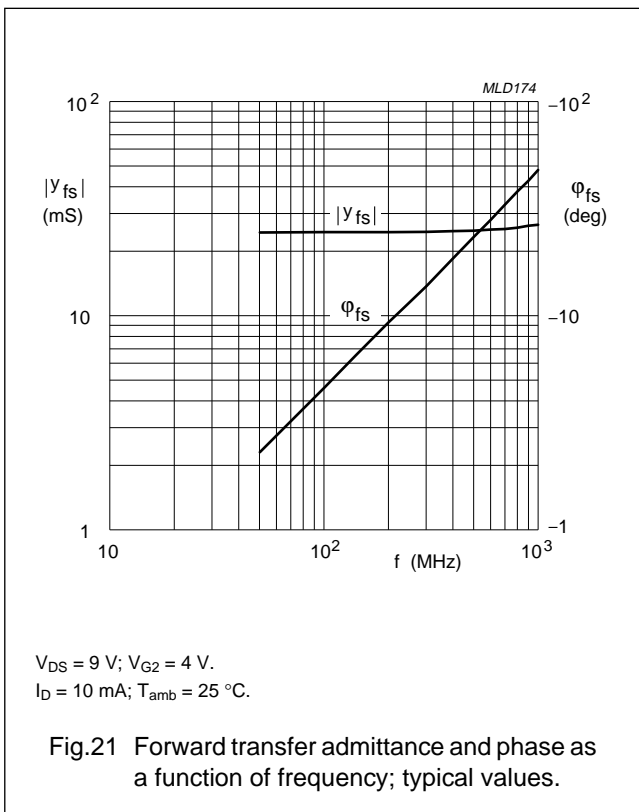
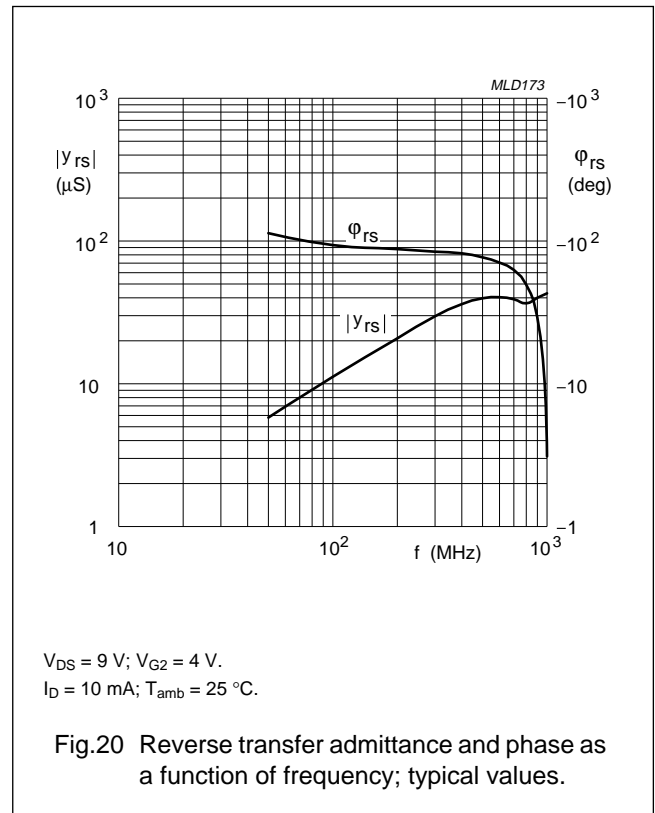
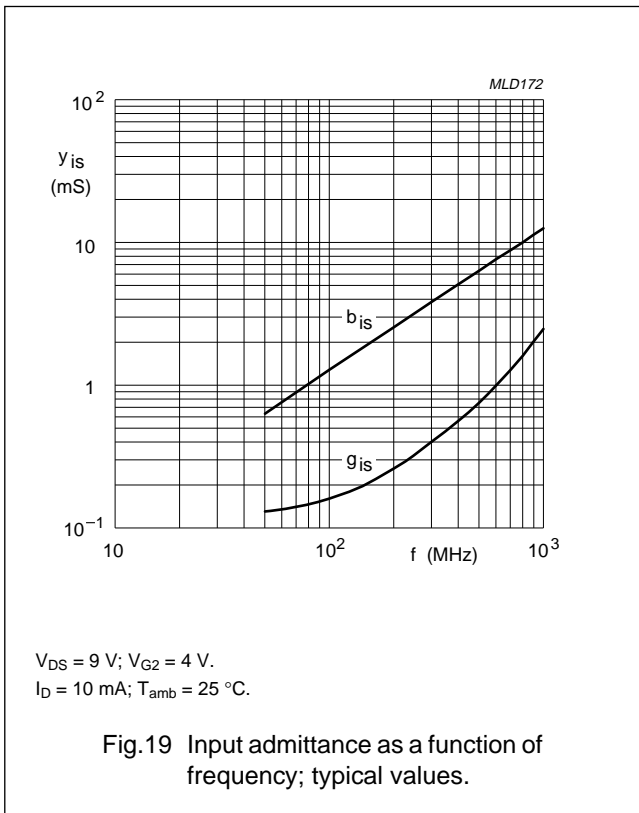

Dual-gate MOS-FETs

BF1100; BF1100R

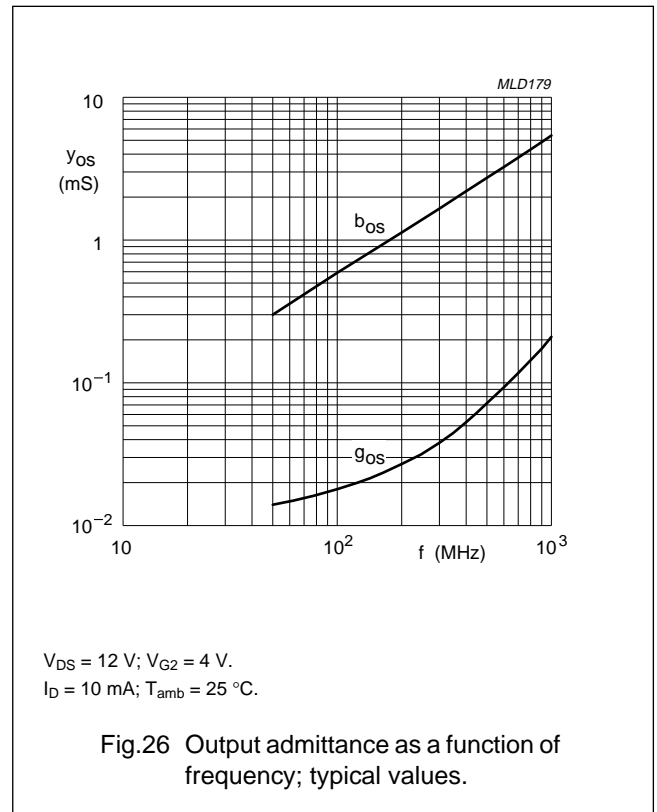
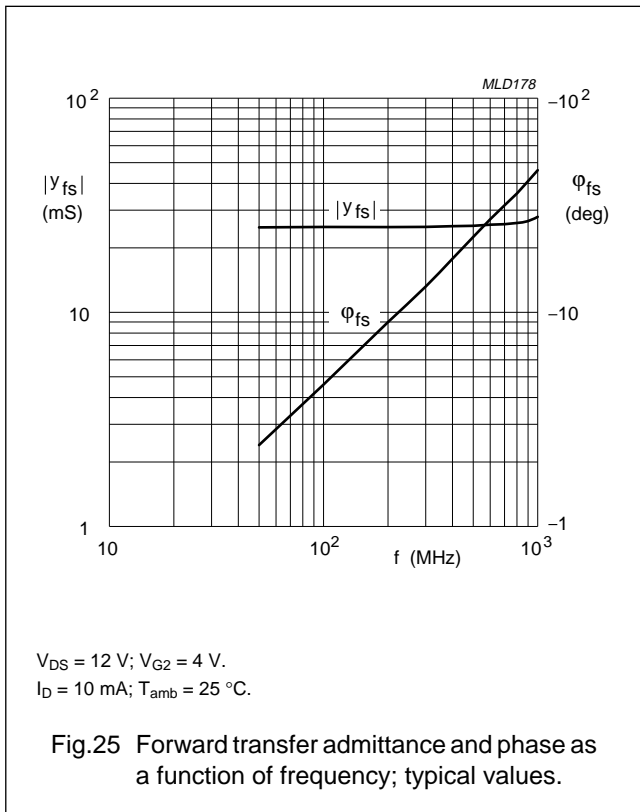
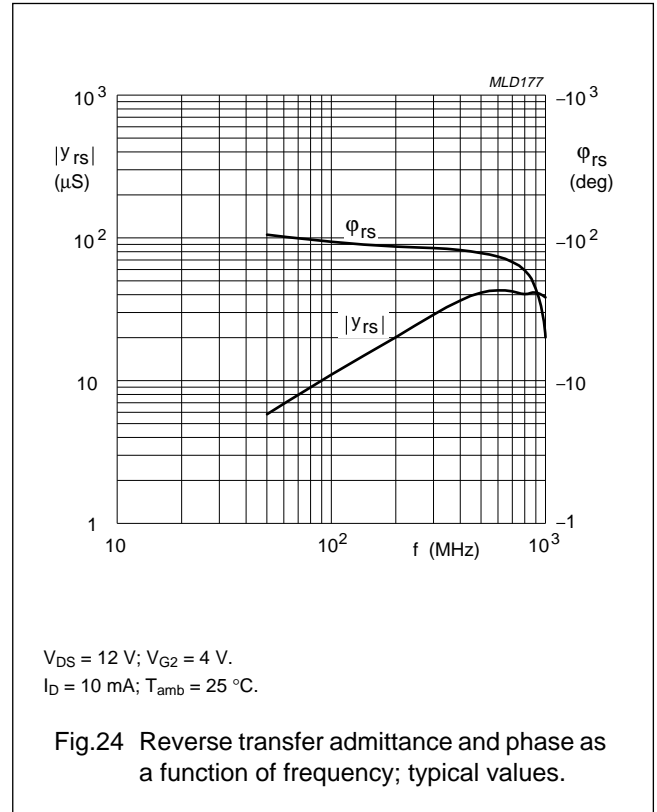
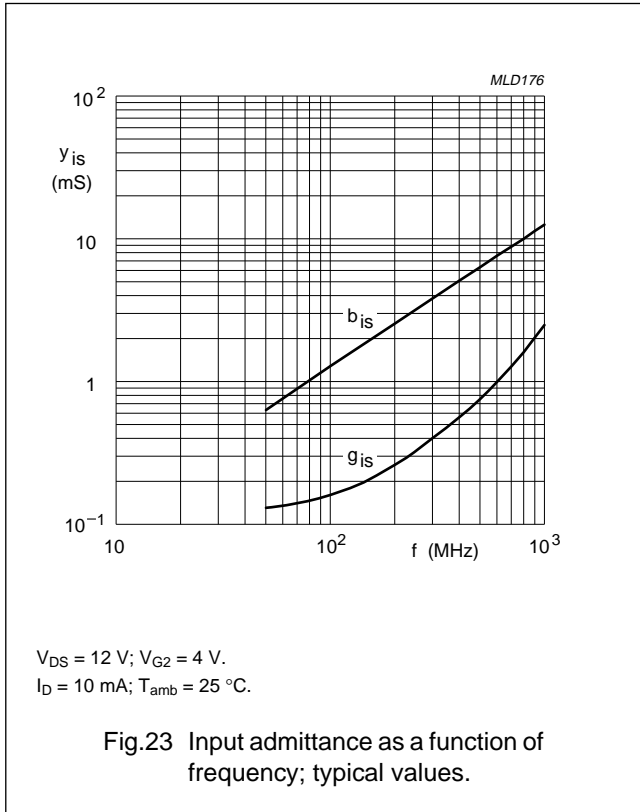

Dual-gate MOS-FETs

BF1100; BF1100R

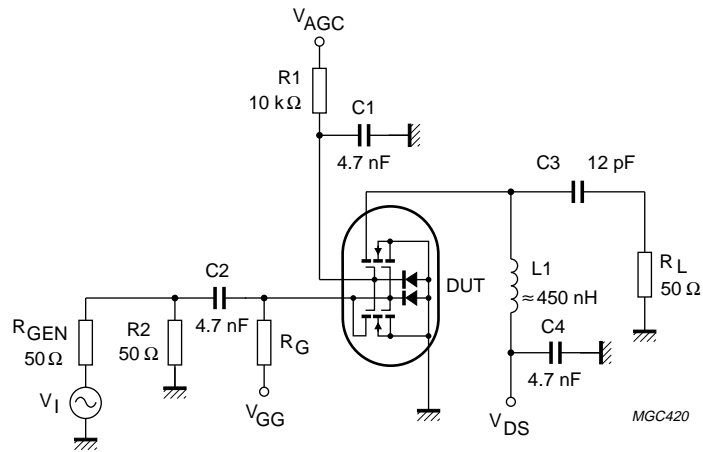

For $V_{GG} = V_{DS} = 9\text{ V}$, $R_G = 180\text{ k}\Omega$.
 For $V_{GG} = V_{DS} = 12\text{ V}$, $R_G = 250\text{ k}\Omega$.

Fig.27 Cross-modulation test set-up.

Dual-gate MOS-FETs

BF1100; BF1100R

Table 1 Scattering parameters: $V_{DS} = 9\text{ V}$; $V_{G2-S} = 4\text{ V}$; $I_D = 10\text{ mA}$

| f (MHz) | S ₁₁ | | S ₂₁ | | S ₁₂ | | S ₂₂ | |
|------------|----------------------|----------------|----------------------|----------------|----------------------|----------------|----------------------|----------------|
| | MAGNITUDE (ratio) | ANGLE (deg) | MAGNITUDE (ratio) | ANGLE (deg) | MAGNITUDE (ratio) | ANGLE (deg) | MAGNITUDE (ratio) | ANGLE (deg) |
| 50 | 0.986 | -3.6 | 2.528 | 174.4 | 0.001 | 63.7 | 1.000 | -2.0 |
| 100 | 0.983 | -7.4 | 2.531 | 169.8 | 0.001 | 80.7 | 1.000 | -4.2 |
| 200 | 0.974 | -14.7 | 2.490 | 159.5 | 0.002 | 81.0 | 0.996 | -8.1 |
| 300 | 0.960 | -21.8 | 2.446 | 149.8 | 0.002 | 80.3 | 0.994 | -11.9 |
| 400 | 0.953 | -28.7 | 2.412 | 139.8 | 0.003 | 76.3 | 0.992 | -15.7 |
| 500 | 0.933 | -35.4 | 2.341 | 130.1 | 0.003 | 76.5 | 0.987 | -19.4 |
| 600 | 0.915 | -42.0 | 2.283 | 120.4 | 0.004 | 79.0 | 0.984 | -23.0 |
| 700 | 0.895 | -47.9 | 2.205 | 111.6 | 0.003 | 81.5 | 0.981 | -26.7 |
| 800 | 0.880 | -53.5 | 2.146 | 102.9 | 0.003 | 90.8 | 0.978 | -30.3 |
| 900 | 0.864 | -59.6 | 2.087 | 93.4 | 0.003 | 106.6 | 0.974 | -33.9 |
| 1000 | 0.839 | -65.0 | 1.998 | 84.4 | 0.003 | 135.4 | 0.971 | -37.6 |

Table 2 Noise data: $V_{DS} = 9\text{ V}$; $V_{G2-S} = 4\text{ V}$; $I_D = 10\text{ mA}$

| f (MHz) | F _{min} (dB) | Γ _{opt} | | r _n |
|------------|--------------------------|------------------|-------|----------------|
| | | (ratio) | (deg) | |
| 800 | 2.00 | 0.67 | 43.9 | 0.89 |

Table 3 Scattering parameters: $V_{DS} = 12\text{ V}$; $V_{G2-S} = 4\text{ V}$; $I_D = 10\text{ mA}$

| f (MHz) | S ₁₁ | | S ₂₁ | | S ₁₂ | | S ₂₂ | |
|------------|----------------------|----------------|----------------------|----------------|----------------------|----------------|----------------------|----------------|
| | MAGNITUDE (ratio) | ANGLE (deg) | MAGNITUDE (ratio) | ANGLE (deg) | MAGNITUDE (ratio) | ANGLE (deg) | MAGNITUDE (ratio) | ANGLE (deg) |
| 50 | 0.986 | -3.7 | 2.478 | 174.7 | 0.001 | 72.2 | 1.000 | -1.6 |
| 100 | 0.984 | -7.4 | 2.480 | 170.3 | 0.001 | 80.9 | 1.000 | -3.5 |
| 200 | 0.974 | -14.6 | 2.440 | 160.6 | 0.002 | 82.7 | 0.997 | -6.6 |
| 300 | 0.960 | -21.8 | 2.400 | 151.4 | 0.002 | 79.9 | 0.996 | -9.7 |
| 400 | 0.953 | -28.7 | 2.371 | 141.9 | 0.003 | 77.7 | 0.994 | -12.8 |
| 500 | 0.933 | -35.3 | 2.306 | 132.7 | 0.003 | 77.1 | 0.991 | -15.8 |
| 600 | 0.915 | -41.9 | 2.255 | 123.6 | 0.004 | 77.1 | 0.989 | -18.7 |
| 700 | 0.894 | -47.8 | 2.183 | 115.3 | 0.004 | 79.3 | 0.986 | -21.7 |
| 800 | 0.879 | -53.5 | 2.131 | 107.2 | 0.003 | 83.9 | 0.984 | -24.6 |
| 900 | 0.863 | -59.5 | 2.080 | 98.2 | 0.003 | 95.1 | 0.982 | -27.5 |
| 1000 | 0.838 | -65.0 | 1.999 | 89.7 | 0.003 | 115.8 | 0.980 | -30.4 |

Table 4 Noise data: $V_{DS} = 12\text{ V}$; $V_{G2-S} = 4\text{ V}$; $I_D = 10\text{ mA}$

| f (MHz) | F _{min} (dB) | Γ _{opt} | | r _n |
|------------|--------------------------|------------------|-------|----------------|
| | | (ratio) | (deg) | |
| 800 | 2.00 | 0.66 | 43.3 | 0.97 |

Dual-gate MOS-FETs

BF1100; BF1100R

PACKAGE OUTLINES

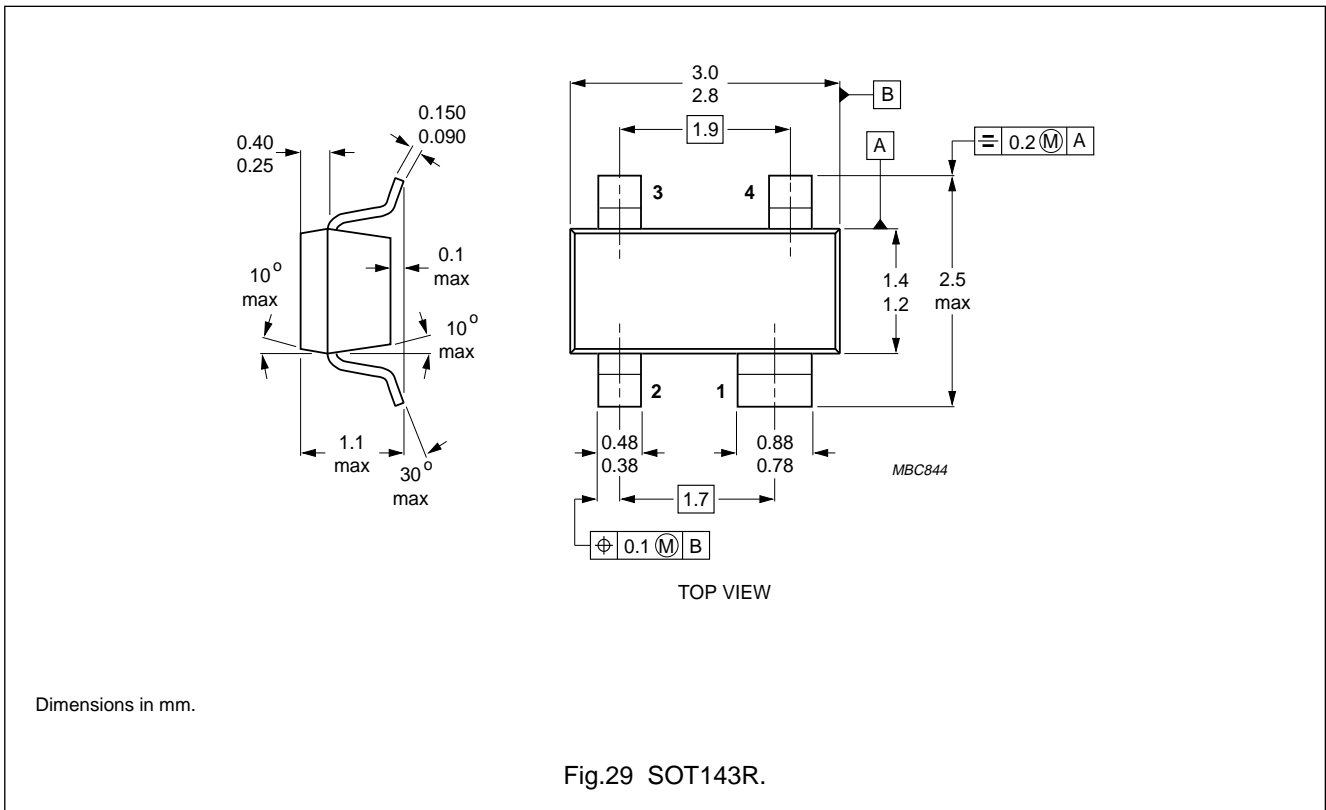
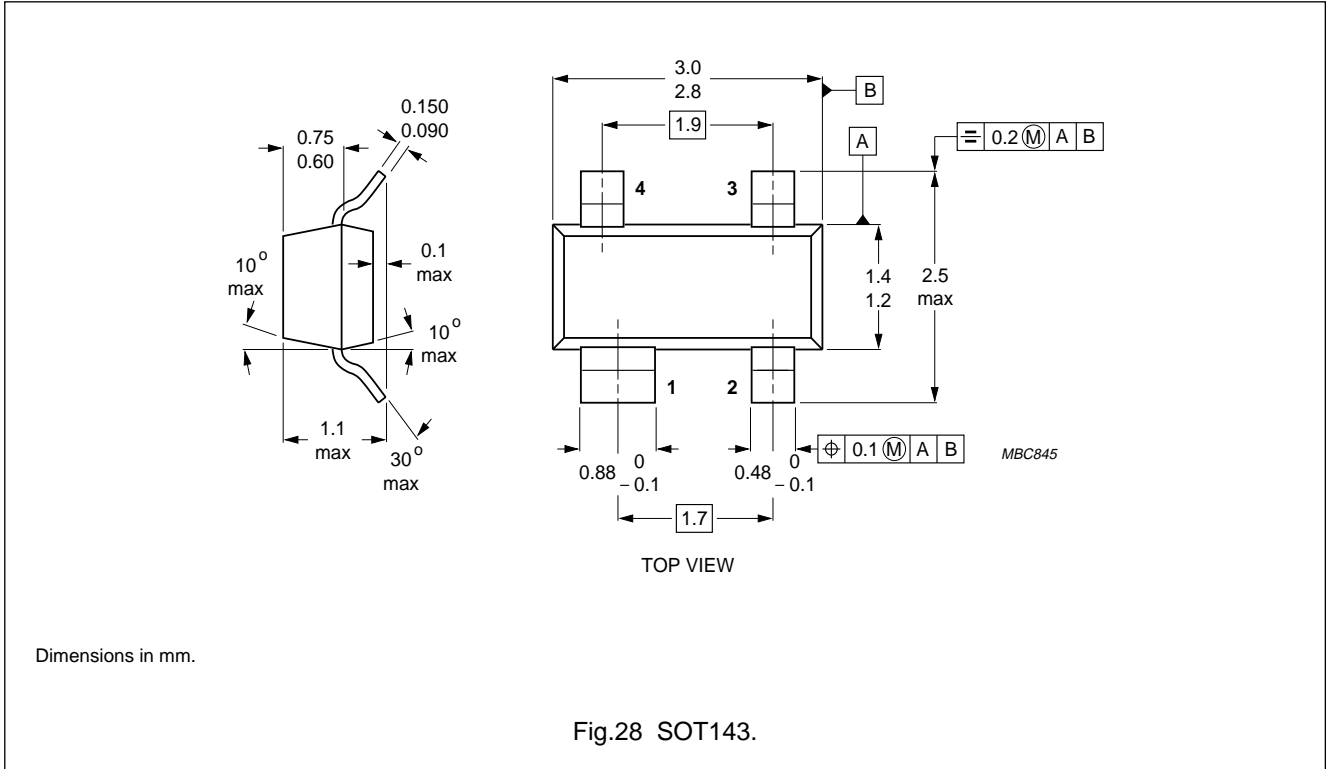

Dual-gate MOS-FETs

BF1100; BF1100R

DEFINITIONS

| Data Sheet Status | |
|---|---|
| Objective specification | This data sheet contains target or goal specifications for product development. |
| Preliminary specification | This data sheet contains preliminary data; supplementary data may be published later. |
| Product specification | This data sheet contains final product specifications. |
| Limiting values | |
| Limiting values given are in accordance with the Absolute Maximum Rating System (IEC 134). Stress above one or more of the limiting values may cause permanent damage to the device. These are stress ratings only and operation of the device at these or at any other conditions above those given in the Characteristics sections of the specification is not implied. Exposure to limiting values for extended periods may affect device reliability. | |
| Application information | |
| Where application information is given, it is advisory and does not form part of the specification. | |

LIFE SUPPORT APPLICATIONS

These products are not designed for use in life support appliances, devices, or systems where malfunction of these products can reasonably be expected to result in personal injury. Philips customers using or selling these products for use in such applications do so at their own risk and agree to fully indemnify Philips for any damages resulting from such improper use or sale.