

# HOA1397

## Reflective Sensor

### FEATURES

- Choice of phototransistor or photodarlington output
- Low profile for design flexibility
- Unfocused for sensing diffused surfaces

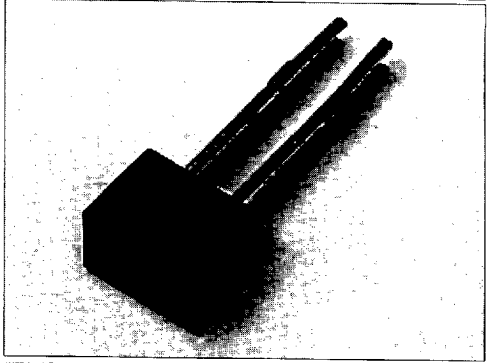

MFRA-10.TIF

### DESCRIPTION

The HOA1397 series consists of an infrared emitting diode and an NPN silicon phototransistor (HOA1397-001, -002) or photodarlington (HOA1397-031, 032) encased side-by-side on parallel axes in a miniature black thermoplastic housing. The detector responds to radiation from the IRED only when a reflective object passes within its field of view. The HOA1397 series employs plastic molded components. For additional component information refer to SEP8507 and SDP8407.

Housing material is polyester. Housings are soluble in chlorinated hydrocarbons and ketones. Recommended cleaning agents are methanol and isopropanol.

### OUTLINE DIMENSIONS in inches (mm)

Tolerance 3 plc decimals  $\pm 0.010(0.25)$   
2 plc decimals  $\pm 0.020(0.51)$

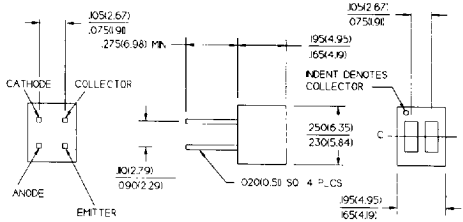

DIM\_036.cdr

4551830 0022641 366  
**honeywell**

Honeywell reserves the right to make changes in order to improve design and supply the best products possible.

# HOA1397

## Reflective Sensor

### ELECTRICAL CHARACTERISTIC (25°C unless otherwise noted)

PARAMETER	SYMBOL	MIN	TYP	MAX	UNITS	TEST CONDITIONS
<b>IR EMITTER</b>						
Forward Voltage	$V_F$			1.6	V	$I_F=20\text{ mA}$
Reverse Leakage Current	$I_R$			10	$\mu\text{A}$	$V_R=3\text{ V}$
<b>DETECTOR</b>						
Collector-Emitter Breakdown Voltage HOA1397-001, -002 HOA1397-031, -032	$V_{(BR)CEO}$	30 15			V	$I_C=100\text{ }\mu\text{A}$
Emitter-Collector Breakdown Voltage	$V_{(BR)ECO}$	5.0			V	$I_E=100\text{ }\mu\text{A}$
Collector Dark Current HOA1397-001, -002 HOA1397-031, -032	$I_{CEO}$			100 250	nA	$V_{CE}=10\text{ V}$ $I_F=0$
<b>COUPLED CHARACTERISTICS</b>						
On-State Collector Current HOA1397-001 HOA1397-002 HOA1397-031 HOA1397-032	$I_{C(ON)}$	0.2 0.7 2.0 7.0			mA	$V_{CE}=5\text{ V}$ $I_F=20\text{ mA}$ (1)
Collector-Emitter Saturation Voltage HOA1397-001 HOA1397-002 HOA1397-031 HOA1397-032	$V_{CE(SAT)}$			0.4 0.4 1.1 1.1	V	$I_F=20\text{ mA}$ (1) $I_C=30\text{ }\mu\text{A}$ $I_C=90\text{ }\mu\text{A}$ $I_C=250\text{ }\mu\text{A}$ $I_C=880\text{ }\mu\text{A}$
Rise And Fall Time HOA1397-001, -002 HOA1397-031, -032	$t_r, t_f$		15 75		$\mu\text{s}$	$V_{CC}=5\text{ V}$ , $I_C=1\text{ mA}$ $R_L=1000\text{ }\Omega$ $R_L=100\text{ }\Omega$

#### Notes

1. Test surface is a Eastman Kodak Neutral white test card with 90% diffuse reflectance located 0.05 in. (1.27 mm) from the front surface of the device.

### ABSOLUTE MAXIMUM RATINGS

(25°C Free-Air Temperature unless otherwise noted)

Operating Temperature Range	-40°C to 85°C
Storage Temperature Range	-40°C to 85°C
Soldering Temperature (5 sec)	240°C

#### IR EMITTER

Power Dissipation	100 mW (1)
Reverse Voltage	3 V
Continuous Forward Current	60 mA

#### DETECTOR

	TRANS.	DARLINGTON
Collector-Emitter Voltage	30 V	15 V
Emitter-Collector Voltage	5 V	5 V
Power Dissipation	100 mW (1)	100 mW (1)
Collector DC Current	30 mA	30 mA

#### Notes

1. Derate linearly at 0.66 mW/°C above 25°C.

### SCHEMATIC

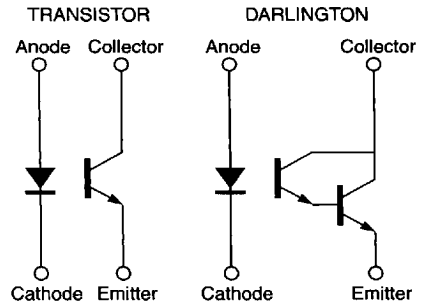

4551830 0022642 2T2

**Honeywell**

Honeywell reserves the right to make changes in order to improve design and supply the best products possible.

245

# HOA1397

## Reflective Sensor

Fig. 1 IRED Forward Bias Characteristics

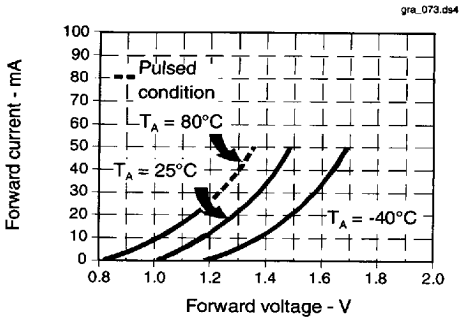

Fig. 2 Non-Saturated Switching Time vs Load Resistance

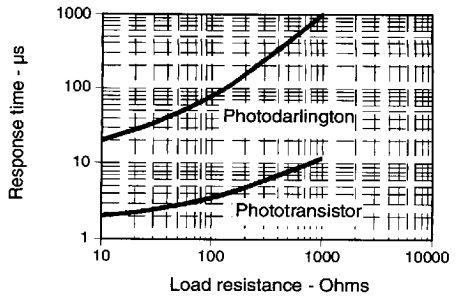

Fig. 3 Dark Current vs Temperature

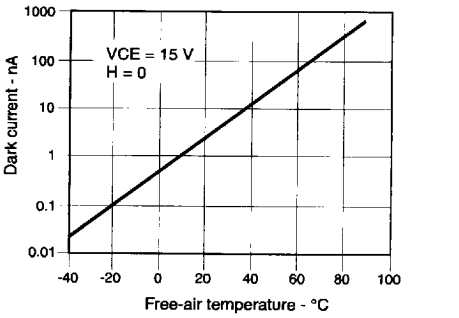

Fig. 4 Collector Current vs Ambient Temperature

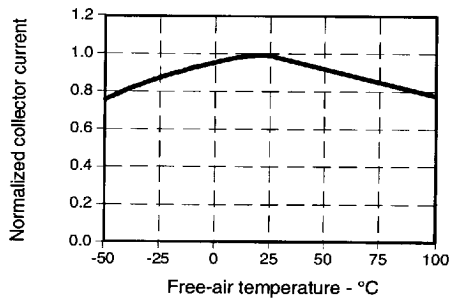

Fig. 5 Collector Current vs Distance to Reflective Surface

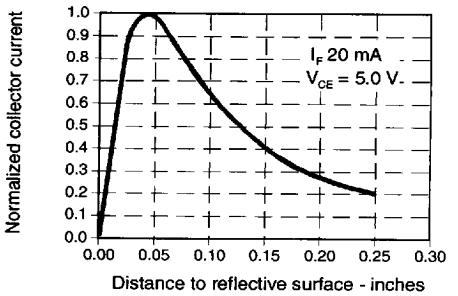
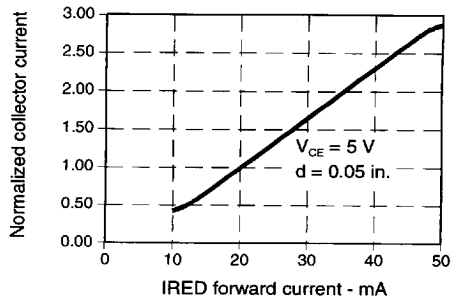

Fig. 6 Collector Current vs IRED Forward Current



All Performance Curves Show Typical Values

4551830 0022643 139

**Honeywell**

Honeywell reserves the right to make changes in order to improve design and supply the best products possible.