

745-080 → 240 -

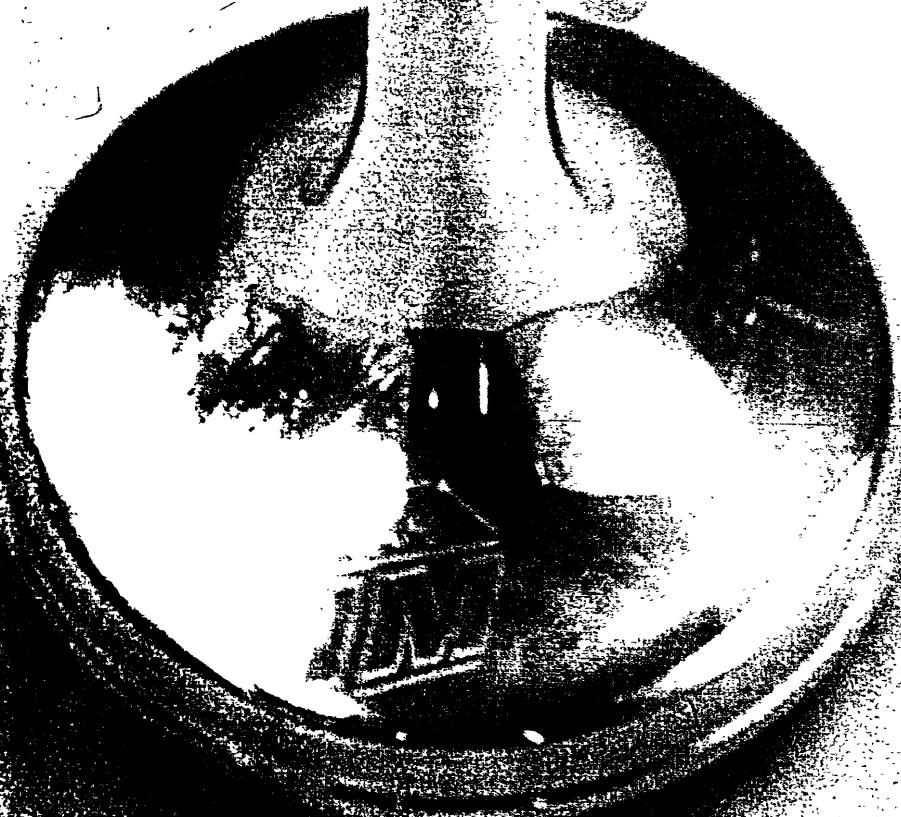

BIMINDICATORS

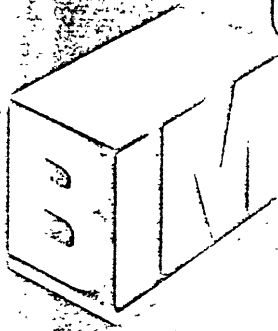

BOSS BIMINDICATORS



501

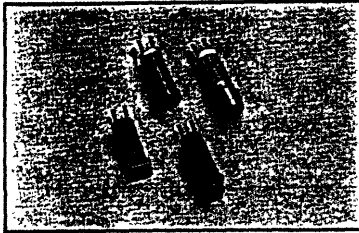

Indicator with polycarbonate body accepts filament bulbs, 05 version also accepts neon resistor. Transparent or opaque lens styles.

Signalleuchte mit Hauptteil aus Polycarbonat. Geeignet nur für Glühlampen; die 05 Version auch geeignet für Glimmlampen. Linsen klar oder matt.

502

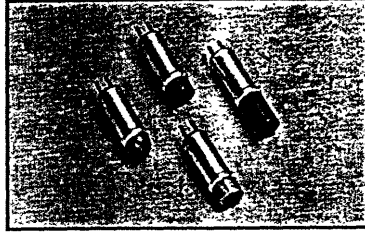

Indicator made in aluminium, accepts filament lamp or neon (resistor external). Transparent or opaque lens styles.

Signalleuchte aus Aluminium. Geeignet für Glimm- oder Glühlampen (Widerstand befindet sich außen). Linsen klar oder matt.

503

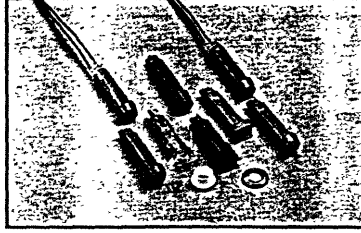

Polycarbonate body indicator. Filament or neon, or body for neons plus integral resistor. Transparent lenses.

Hauptteil aus Polycarbonat für Glimm- oder Glühlampen, oder Hauptteil für Glühlampen mit eingebautem Widerstand. Linsen klar.

504

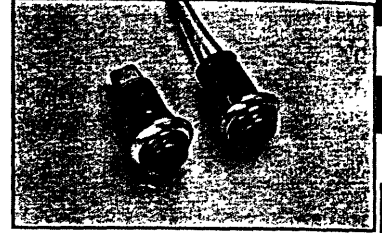

Polycarbonate body with chrome bezel with electro-plated brass solder tags. Transparent or opaque lenses.

Hauptteil aus Polycarbonat mit Zierring aus Chrom mit galvanisch versilberten Messingfedern zum Löteten. Linsen klar oder matt.

505

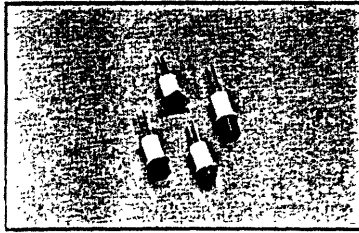

Sub-miniature LED indicators with integral LED's. Transparent or opaque lenses.

Sub-miniatur Signalleuchten mit eingebauten LED Lampen. Hauptteile aus Polycarbonat mit steifem Drahtlitzen. Linsen klar oder matt.

506

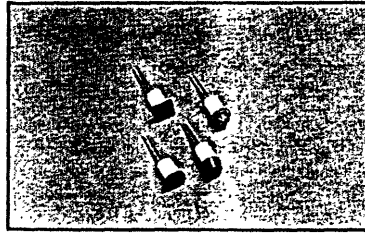

507

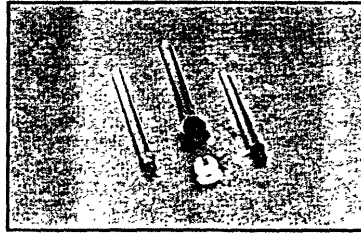

Individual gallium phosphide LED's having 3.2mm and 5mm dia lens and giving 100° and 30° viewing angles respectively. Available in red, green, yellow or amber.

Spezifische Gallium Phosphor Signallampen. Linsen mit 3.2mm und 5mm Durchmesser und 100° und 30° Abstrahlwinkeln. Lieferbar in rot, grün, gelb und amber.

508

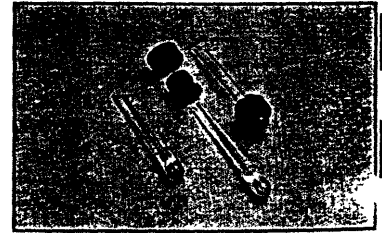

501

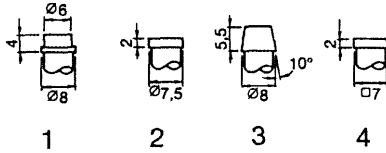
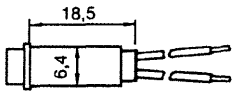

502

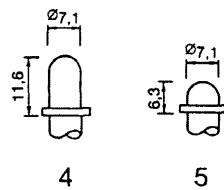
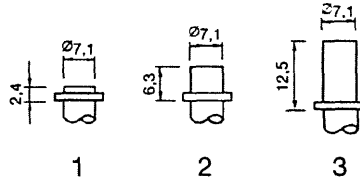
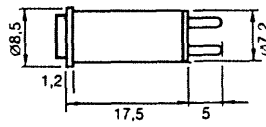

503

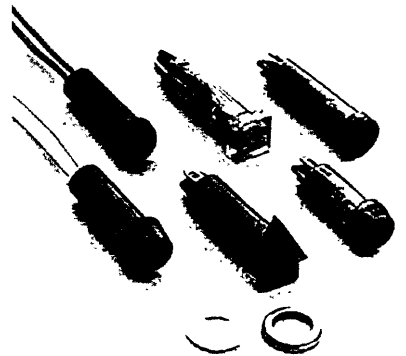
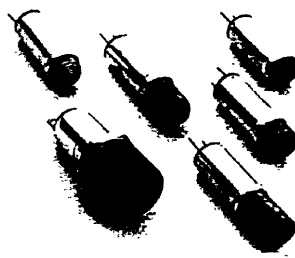
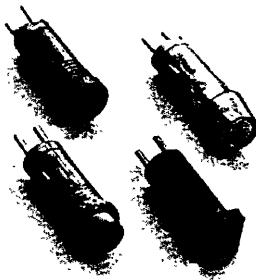
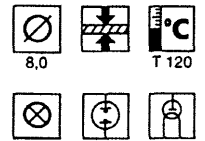
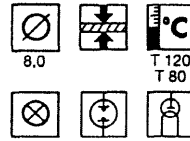
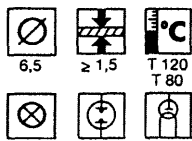
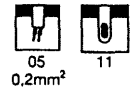
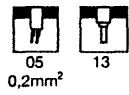
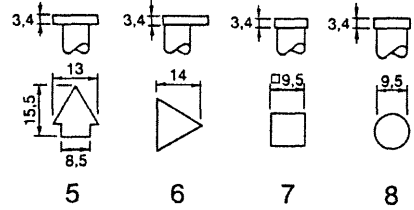
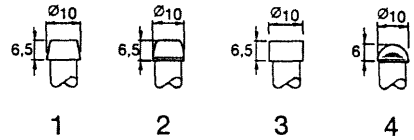
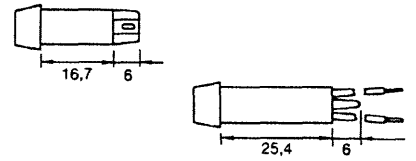

504

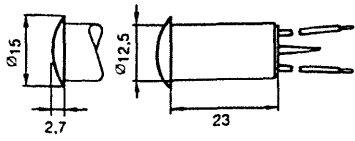

1

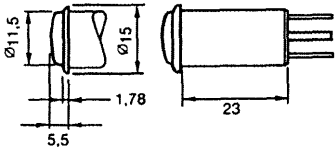

2

505

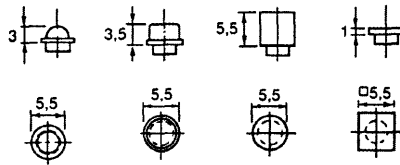
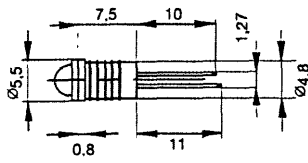

1

2

3

4

506

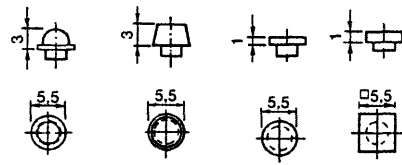
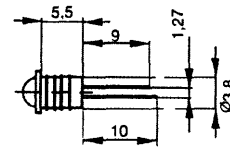

1

2

3

4

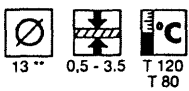
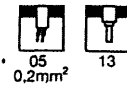
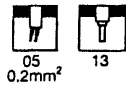
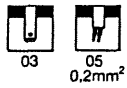

** 12.5 = ohne Chromring

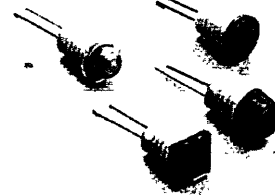
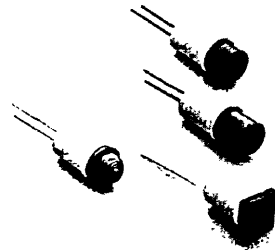
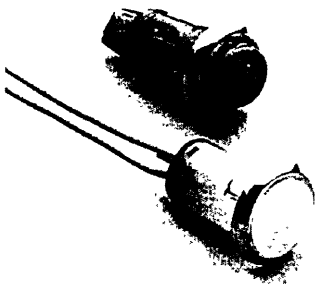
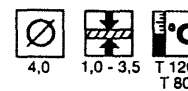
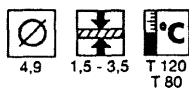

507

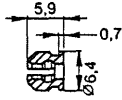
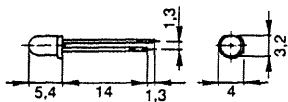

1

508

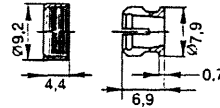
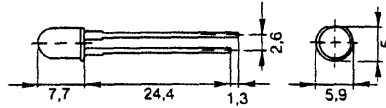

1

509

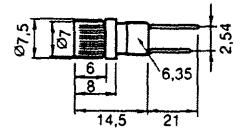

1

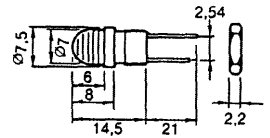

2

ap



13



13



13

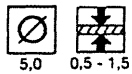

5,0

0,5 - 1,5

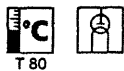

T 80

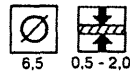

6,5

0,5 - 2,0

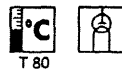

T 80

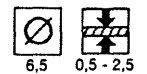

6,5

0,5 - 2,5



T 80

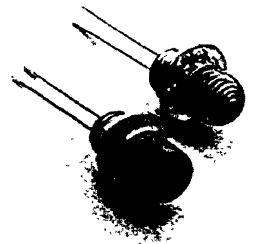
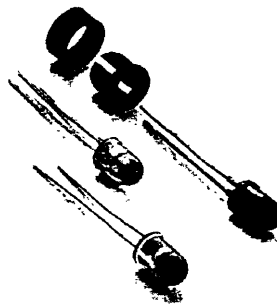
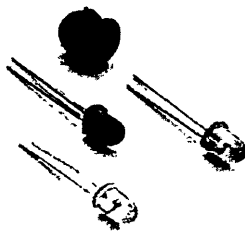

512

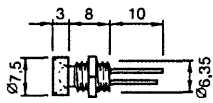

1

513

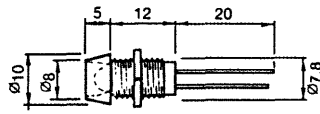

1

514

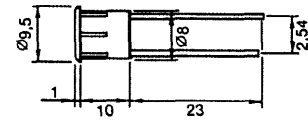

1

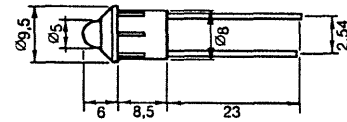

2



13



13



13

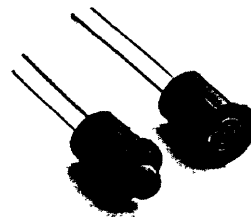
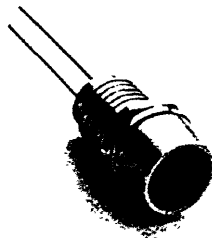
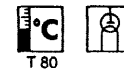
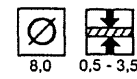
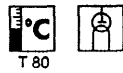
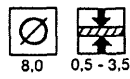
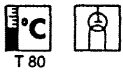
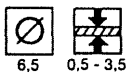

515

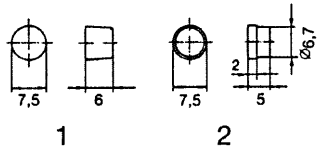
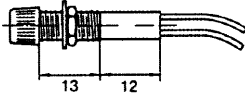

apj

516

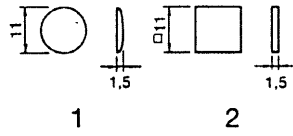
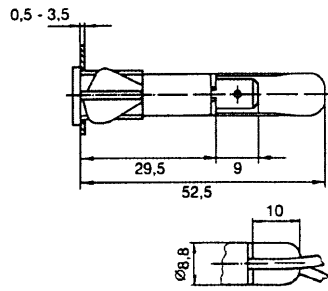

517

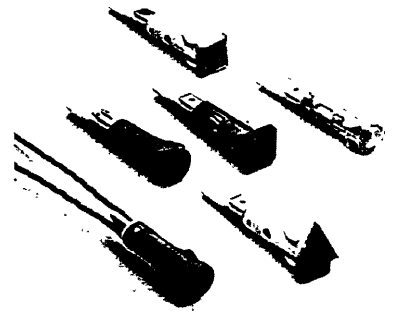
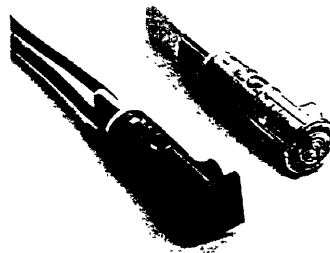
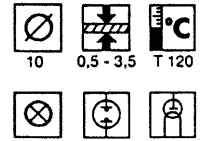
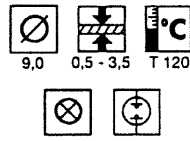
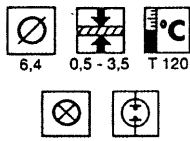
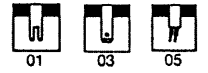
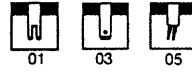
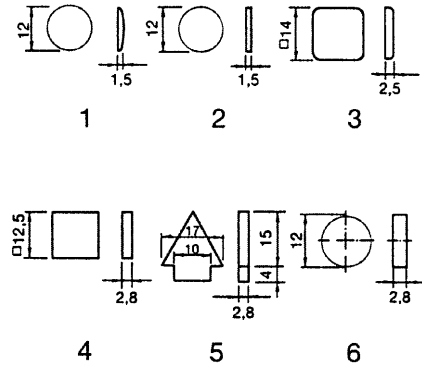
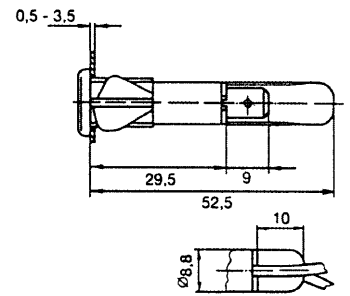

518

519

520

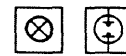
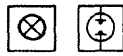
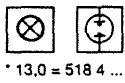
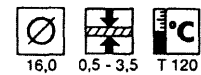
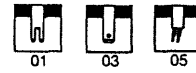
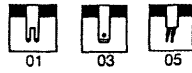
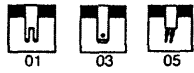
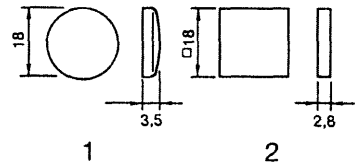
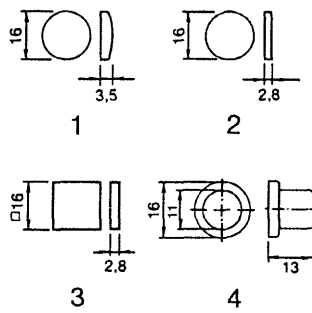
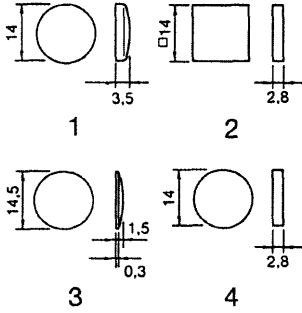
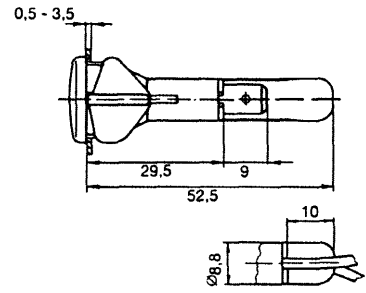
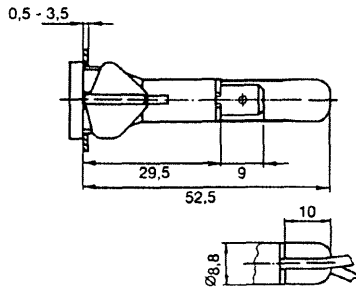
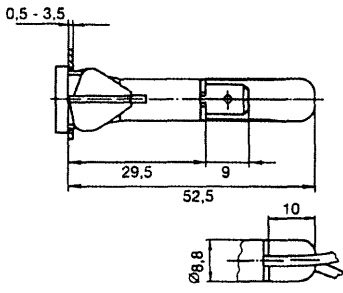

* 13,0 = 518 4 ...



521

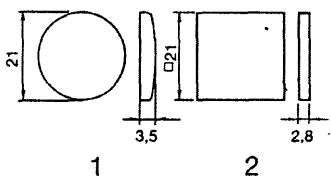
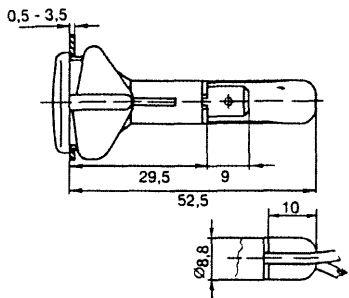

570

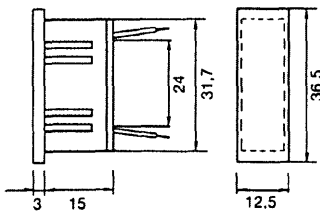

580

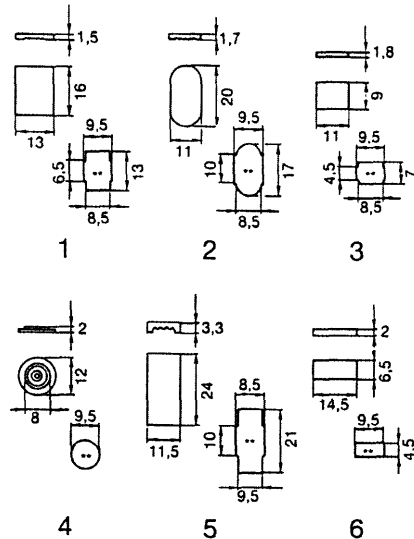
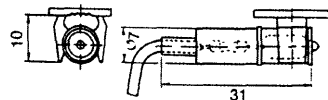

apr

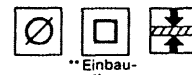
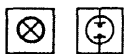

Einbauöffnung

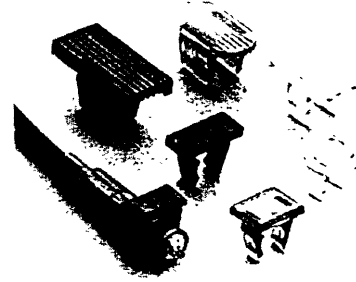
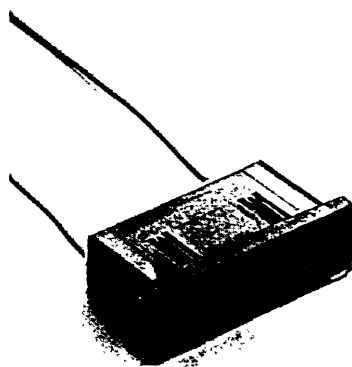
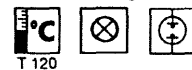

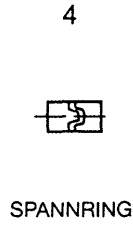
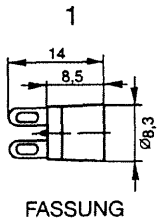

P + B bietet Konfektionierungen in 110 V, 220 V und 380 V- Ausführungen an. Bitte fragen Sie an.

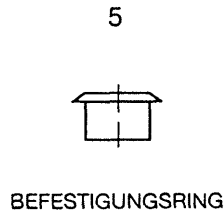
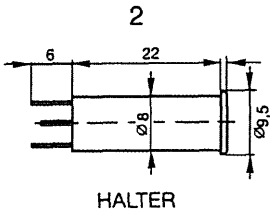

P + B offers assemblies in 110 V, 220 V and 380 V. Please inquire.

P + B offre des assemblages en 110 V, 220 V et 380 V. Envoyez-nous vos demandes.

P + B offre versioni 110 V, 220 V e 380 v. Mandateci le Vs richieste.

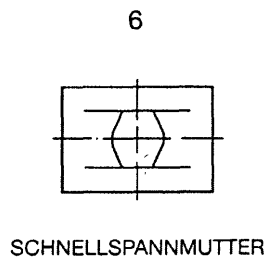
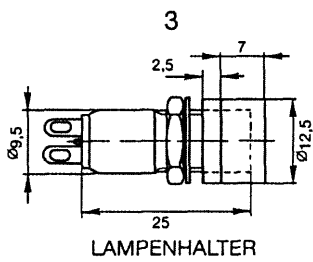

ANWENDUNG BEI ARTIKEL- NR.

ANWENDUNG BEI ARTIKEL- NR.

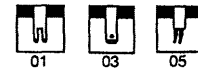

1 501
2 501
3 502

4 501
5 503
6 502

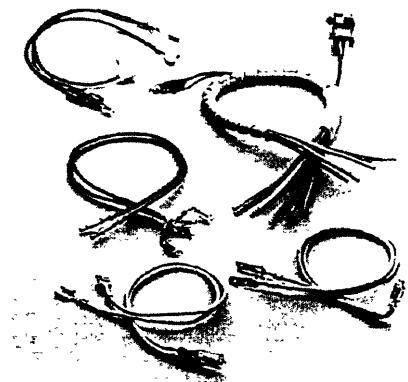
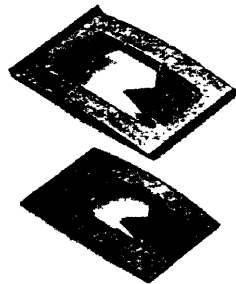
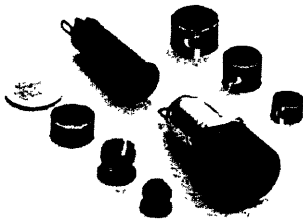

ATORS



BOSS BIMINDICATORS

519

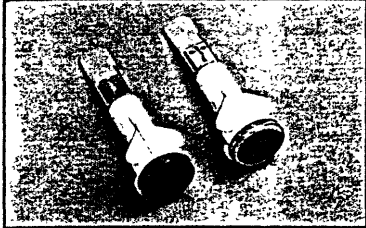

520

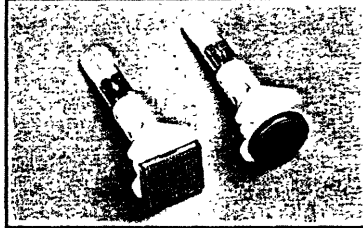

521

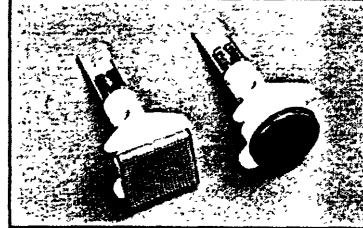

570

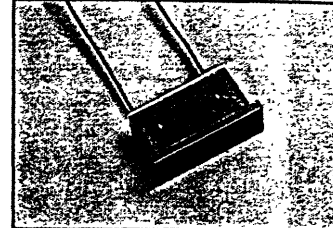

Range moulded in polycarbonate capable of accepting LED, filament and neon lamps together with an integral ballast resistor, where appropriate. Offering 17 round, square or arrow shape lens options, in combination with 6 body sizes. Wings lock indicator into any panel thickness 0.5mm - 3.5mm. Lens colours translucent, clear, green, red and amber.

Rectangular polycarbonate body lens moulding accepts filament lamp or neons with integral resistor. 150mm PVC/ stranded wire terminal.

Lens Dia/ Linsen Durchmesser: 16mm Lens Dia/ Linsen Durchmesser: 18mm Lens Dia/ Linsen Durchmesser: 21mm

Serie aus Polykarbonat für LED's, Glühlampen oder Glimmlampen mit eingebautem Vorwiderstand. 17 runde, viereckige oder pfeilförmige Blendenformen in 6 Hauptteilgrößen. Befestigung durch Federn für Plattenstärke 0,5 bis zu 3mm. Linsen in grün, rot, amber, klar oder matt.

Rechteckige Hauptteil und Linse aus Polykarbonat. Geeignet für Glühlampen oder Glimmlampen, mit eingebautem Vorwiderstand. 150mm PVC/ Drahtend

580

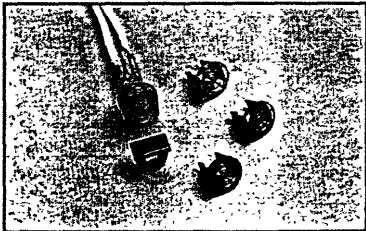

Fasteners

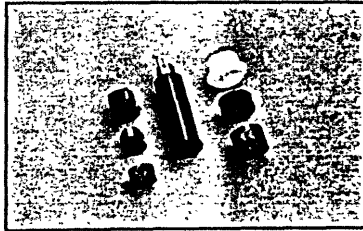

Spire Clips



Clip-on polycarbonate lenses. Polysulphone body. Available in red, clear, amber and green. Optional lens shapes. Silicone lead.

Assorted fasteners for range of indicators.

Rectangular spire clip for 501 & 504 series.

Befestigbare Linsen aus Polykarbonat. Hauptteil aus Polysulphone. Lieferbar in rot, klar, amber und grün. Verschiedene Linsenformen. Draht mit Silicon-Schlauch.

Verschiedene Fassungen für Signalleuchten Serie.

Rechteckige Schnellspannmutter für die 501 und 504 Serien.



BOSS BIMINDICATORS



BOSS BIMINDICA

509



Nickel plated brass body LED fitted with two styles of 6.5mm dia cylindrical Fresnel lens. Both lenses have 30° viewing angle. Available in red, green or amber.

Hauptteil aus vernickeltem Messing, ausgestattet mit zwei Typen zylindrische Fresnel Linsen aus Polycarbonat. Lieferbar in rot, grün und amber.

512

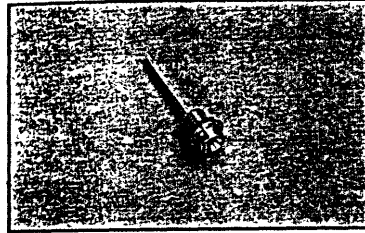

Nickel plated brass fitted with 3.2mm dia LED. 30° front viewing. Available in red, green or amber.

Hauptteil aus vernickeltem Messing mit 3.2mm Durchmesser Signalleuchte. 30° Abstrahlwinkel. Lieferbar in rot, grün und amber.

513

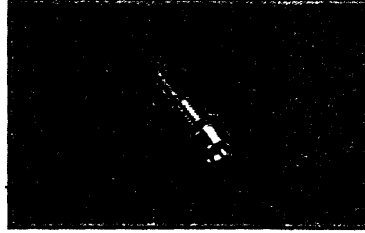

Chromium plated brass fitted with 5mm dia LED. 30° front viewing. Available in red, green or amber.

Hauptteil aus verchromtem Messing, ausgestattet mit 5mm Durchmesser Signalleuchte. Lieferbar in rot, grün und amber.

514

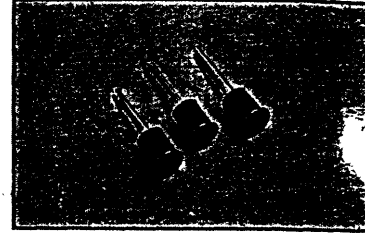

9.5mm dia flat faced front view lens LED giving 30° viewing angle. Both bodies are black Nylon. Lens colours red, green and amber.

5mm Durchmesser Signalleuchte oder 9.5mm Durchmesser flache Linse. Beide Hauptteile sind aus schwarzem Nylon. Linsen lieferbar in rot, grün und amber.

315



6.5mm dia filament or neon lamp. Available in red, green, amber and opal. Voltage range from 6V to 250V.

6.5mm Durchmesser Glöh- oder Neonleuchten. Lieferbar in rot, grün, amber und opal. Spannung von 6V bis zu 250V.

516

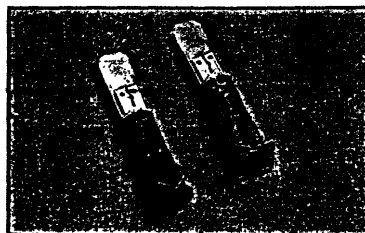

Range moulded in polycarbonate capable of accepting LED, filament and neon lamps together with an integral ballast resistor, where appropriate. Offering 17 round, square or arrow shape lens options, in combination with 6 body sizes. Wings lock indicator into any panel thickness 0.5mm - 3.5mm. Lens colours translucent, clear, green, red and amber.

Lens Dia/ Linsen Durchmesser: 11mm

Lens Dia/ Linsen Durchmesser: 12/ 12.5mm

Lens Dia/ Linsen Durchmesser: 14mm

Serie aus Polycarbonat für LED's, Glühlampen oder Glimmlampen mit eingebautem Vorwiderstand. 17 runde, viereckige oder pfeilförmige Blendenformen in 6 Hauptteilgrößen. Befestigung durch Federn für Plattenstärke 0,5 bis zu 3mm. Linsen in grün, rot, amber, klar oder matt.

517

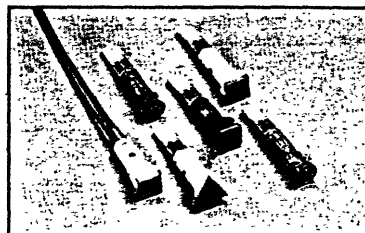

518

