

DAC0800/DAC0802 8-Bit Digital-to-Analog Converters

General Description

The DAC0800 series are monolithic 8-bit high-speed current-output digital-to-analog converters (DAC) featuring typical settling times of 100 ns. When used as a multiplying DAC, monotonic performance over a 40 to 1 reference current range is possible. The DAC0800 series also features high compliance complementary current outputs to allow differential output voltages of 20 V_{p-p} with simple resistor loads as shown in *Figure 1*. The reference-to-full-scale current matching of better than ±1 LSB eliminates the need for full-scale trims in most applications while the nonlinearities of better than ±0.1% over temperature minimizes system error accumulations.

The noise immune inputs of the DAC0800 series will accept TTL levels with the logic threshold pin, V_{LC}, grounded. Changing the V_{LC} potential will allow direct interface to other logic families. The performance and characteristics of the device are essentially unchanged over the full ±4.5V to ±18V power supply range; power dissipation is only 33 mW with ±5V supplies and is independent of the logic input states.

The DAC0800, DAC0802, DAC0800C and DAC0802C are a direct replacement for the DAC-08, DAC-08A, DAC-08C, and DAC-08H, respectively.

Features

- Fast settling output current: 100 ns
- Full scale error: ±1 LSB
- Nonlinearity over temperature: ±0.1%
- Full scale current drift: ±10 ppm/°C
- High output compliance: -10V to +18V
- Complementary current outputs
- Interface directly with TTL, CMOS, PMOS and others
- 2 quadrant wide range multiplying capability
- Wide power supply range: ±4.5V to ±18V
- Low power consumption: 33 mW at ±5V
- Low cost

Typical Applications

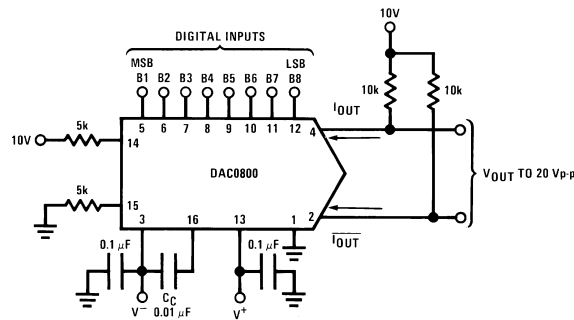

FIGURE 1. ±20 V_{p-p} Output Digital-to-Analog Converter (Note 5)

Ordering Information

Non-Linearity	Temperature Range	Order Numbers				
		J Package (J16A) (Note 1)		N Package (N16E) (Note 1)	SO Package (M16A)	
±0.1% FS	0°C ≤ T _A ≤ +70°C	DAC0802LCJ	DAC-08HQ	DAC0802LCN	DAC-08HP	DAC0802LCM
±0.19% FS	-55°C ≤ T _A ≤ +125°C	DAC0800LJ	DAC-08Q			
±0.19% FS	0°C ≤ T _A ≤ +70°C	DAC0800LCJ	DAC-08EQ	DAC0800LCN	DAC-08EP	DAC0800LCM

Note 1: Devices may be ordered by using either order number.

Absolute Maximum Ratings (Note 2)

If Military/Aerospace specified devices are required, please contact the National Semiconductor Sales Office/Distributors for availability and specifications.

Supply Voltage ($V^+ - V^-$)	$\pm 18V$ or $36V$
Power Dissipation (Note 3)	500 mW
Reference Input Differential Voltage (V14 to V15)	V^- to V^+
Reference Input Common-Mode Range (V14, V15)	V^- to V^+
Reference Input Current	5 mA
Logic Inputs	V^- to V^- plus $36V$
Analog Current Outputs ($V_S = -15V$)	4.25 mA
ESD Susceptibility (Note 4)	TBD V

Storage Temperature	$-65^\circ C$ to $+150^\circ C$
Lead Temp. (Soldering, 10 seconds)	
Dual-In-Line Package (plastic)	$260^\circ C$
Dual-In-Line Package (ceramic)	$300^\circ C$
Surface Mount Package	
Vapor Phase (60 seconds)	$215^\circ C$
Infrared (15 seconds)	$220^\circ C$

Operating Conditions (Note 2)

	Min	Max	Units
Temperature (T_A)			$^\circ C$
DAC0800L	-55	+125	$^\circ C$
DAC0800LC	0	+70	$^\circ C$
DAC0802LC	0	+70	$^\circ C$

Electrical Characteristics

The following specifications apply for $V_S = \pm 15V$, $I_{REF} = 2$ mA and $T_{MIN} \leq T_A \leq T_{MAX}$ unless otherwise specified. Output characteristics refer to both I_{OUT} and I_{OUT-} .

Symbol	Parameter	Conditions	DAC0802LC			DAC0800L/ DAC0800LC			Units
			Min	Typ	Max	Min	Typ	Max	
	Resolution		8	8	8	8	8	8	Bits
	Monotonicity		8	8	8	8	8	8	Bits
	Nonlinearity				± 0.1			± 0.19	%FS
t_s	Settling Time	To $\pm 1/2$ LSB, All Bits Switched "ON" or "OFF", $T_A = 25^\circ C$ DAC0800L DAC0800LC		100	135		100	135	ns
t_{PLH} , t_{PHL}	Propagation Delay Each Bit All Bits Switched	$T_A = 25^\circ C$		35	60		35	60	ns
TC_{FS}	Full Scale Tempco			± 10	± 50		± 10	± 50	ppm/ $^\circ C$
V_{OC}	Output Voltage Compliance	Full Scale Current Change $< 1/2$ LSB, $R_{OUT} > 20$ M Ω Typ	-10		18	-10		18	V
I_{FS4}	Full Scale Current	$V_{REF} = 10.000V$, $R14 = 5.000$ k Ω $R15 = 5.000$ k Ω , $T_A = 25^\circ C$	1.984	1.992	2.000	1.94	1.99	2.04	mA
I_{FSS}	Full Scale Symmetry	$I_{FS4} - I_{FS2}$		± 0.5	± 4.0		± 1	± 8.0	μA
I_{ZS}	Zero Scale Current			0.1	1.0		0.2	2.0	μA
I_{FSR}	Output Current Range	$V^- = -5V$ $V^- = -8V$ to $-18V$	0	2.0	2.1	0	2.0	2.1	mA
V_{IL} V_{IH}	Logic Input Levels Logic "0" Logic "1"	$V_{LC} = 0V$			0.8			0.8	V
I_{IL} I_{IH}	Logic Input Current Logic "0" Logic "1"	$V_{LC} = 0V$ $-10V \leq V_{IN} \leq +0.8V$ $2V \leq V_{IN} \leq +18V$		-2.0	-10		-2.0	-10	μA
V_{IS}	Logic Input Swing	$V^- = -15V$	-10		18	-10		18	V
V_{THR}	Logic Threshold Range	$V_S = \pm 15V$	-10		13.5	-10		13.5	V
I_{15}	Reference Bias Current			-1.0	-3.0		-1.0	-3.0	μA
d/dt	Reference Input Slew Rate	(Figure 11)	4.0	8.0		4.0	8.0		mA/ μs
PSSI $_{FS+}$	Power Supply Sensitivity	$4.5V \leq V^* \leq 18V$		0.0001	0.01		0.0001	0.01	%/%
PSSI $_{FS-}$		$-4.5V \leq V^- \leq 18V$ $I_{REF} = 1mA$		0.0001	0.01		0.0001	0.01	%/%

Electrical Characteristics (Continued)

The following specifications apply for $V_S = \pm 15V$, $I_{REF} = 2 \text{ mA}$ and $T_{MIN} \leq T_A \leq T_{MAX}$ unless otherwise specified. Output characteristics refer to both I_{OUT} and $\overline{I_{OUT}}$.

Symbol	Parameter	Conditions	DAC0802LC			DAC0800L/ DAC0800LC			Units
			Min	Typ	Max	Min	Typ	Max	
I+ I-	Power Supply Current	$V_S = \pm 5V$, $I_{REF} = 1 \text{ mA}$		2.3	3.8		2.3	3.8	mA
				-4.3	-5.8		-4.3	-5.8	mA
		$V_S = 5V$, $-15V$, $I_{REF} = 2 \text{ mA}$		2.4	3.8		2.4	3.8	mA
				-6.4	-7.8		-6.4	-7.8	mA
I+ I-	Power Supply Current	$V_S = \pm 15V$, $I_{REF} = 2 \text{ mA}$		2.5	3.8		2.5	3.8	mA
				-6.5	-7.8		-6.5	-7.8	mA
P _D	Power Dissipation	$\pm 5V$, $I_{REF} = 1 \text{ mA}$		33	48		33	48	mW
		$5V, -15V$, $I_{REF} = 2 \text{ mA}$		108	136		108	136	mW
		$\pm 15V$, $I_{REF} = 2 \text{ mA}$		135	174		135	174	mW

Note 2: Absolute Maximum Ratings indicate limits beyond which damage to the device may occur. DC and AC electrical specifications do not apply when operating the device beyond its specified operating conditions.

Note 3: The maximum junction temperature of the DAC0800 and DAC0802 is 125°C. For operating at elevated temperatures, devices in the Dual-In-Line J package must be derated based on a thermal resistance of 100°C/W, junction-to-ambient, 175°C/W for the molded Dual-In-Line N package and 100°C/W for the Small Outline M package.

Note 4: Human body model, 100 pF discharged through a 1.5 kΩ resistor.

Note 5: Pin-out numbers for the DAC080X represent the Dual-In-Line package. The Small Outline package pin-out differs from the Dual-In-Line package.

Connection Diagrams

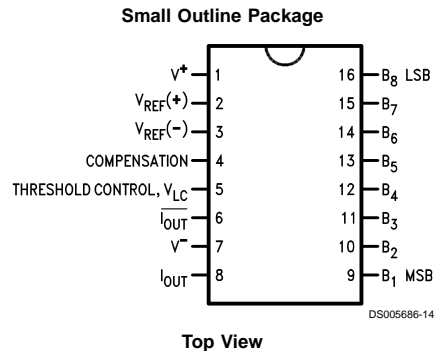
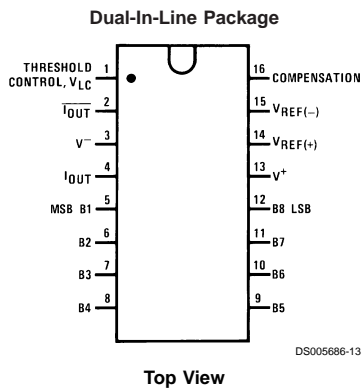

See Ordering Information

Block Diagram (Note 5)

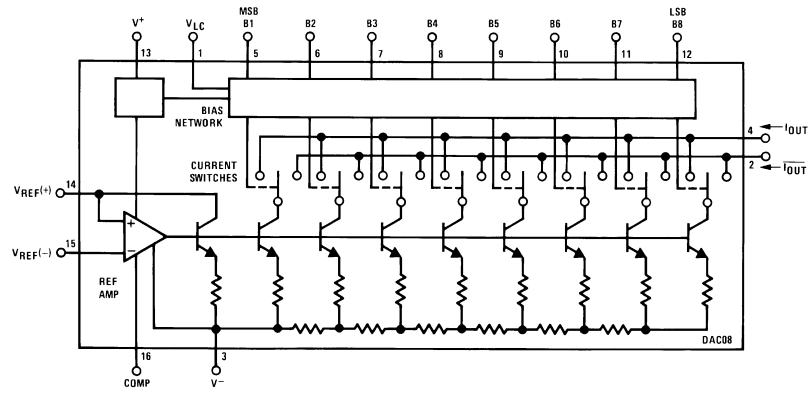

DS005686-2

Typical Performance Characteristics

Full Scale Current vs Reference Current

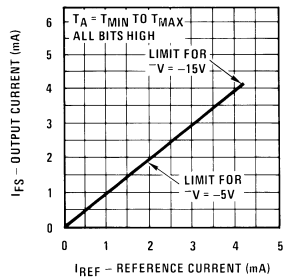

DS005686-22

LSB Propagation Delay vs I_{FS}

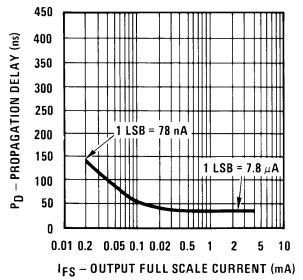

DS005686-23

Reference Input Frequency Response

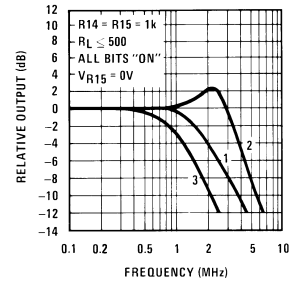

DS005686-24

Curve 1: $C_C = 15$ pF, $V_{IN} = 2$ Vp-p centered at 1V.
Curve 2: $C_C = 15$ pF, $V_{IN} = 50$ mVp-p centered at 200 mV.
Curve 3: $C_C = 0$ pF, $V_{IN} = 100$ mVp-p centered at 0V and applied through 50Ω connected to pin 14.2V applied to R14.

Reference Amp Common-Mode Range

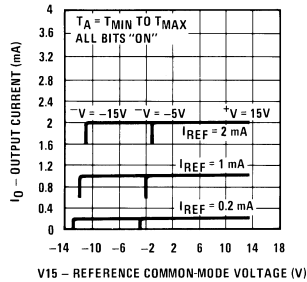

DS005686-25

Note. Positive common-mode range is always $(V+) - 1.5V$.

Logic Input Current vs Input Voltage

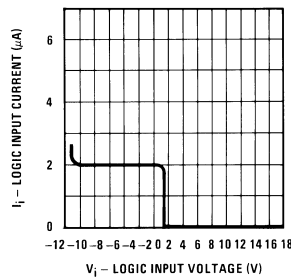

DS005686-26

V_{TH} - V_{LC} vs Temperature

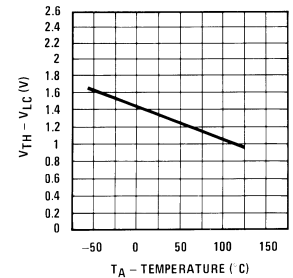

DS005686-27

Typical Performance Characteristics (Continued)

Output Current vs Output Voltage (Output Voltage Compliance)

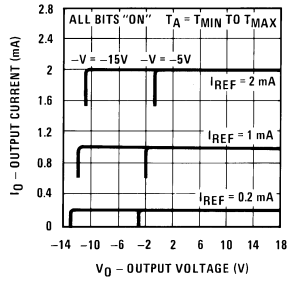

DS005686-28

Output Voltage Compliance vs Temperature

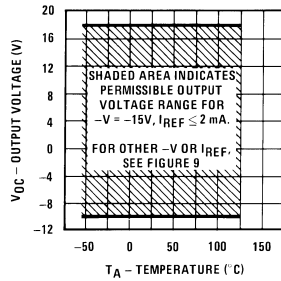

DS005686-29

Bit Transfer Characteristics

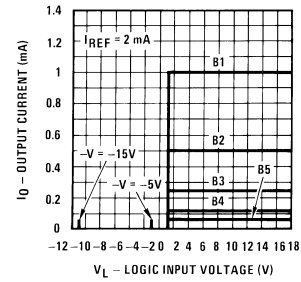

DS005686-30

Note. B1-B8 have identical transfer characteristics. Bits are fully switched with less than 1/2 LSB error, at less than ±100 mV from actual threshold. These switching points are guaranteed to lie between 0.8 and 2V over the operating temperature range ($V_{LC} = 0V$).

Power Supply Current vs +V

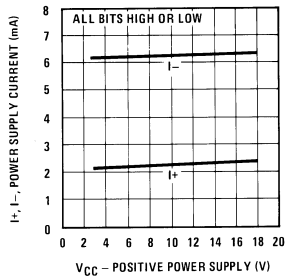

DS005686-31

Power Supply Current vs -V

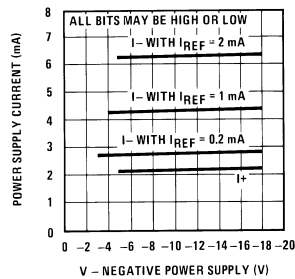

DS005686-32

Power Supply Current vs Temperature

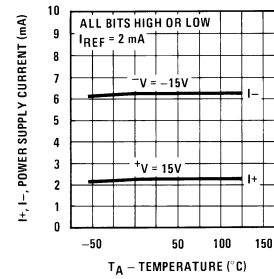

DS005686-33

Equivalent Circuit

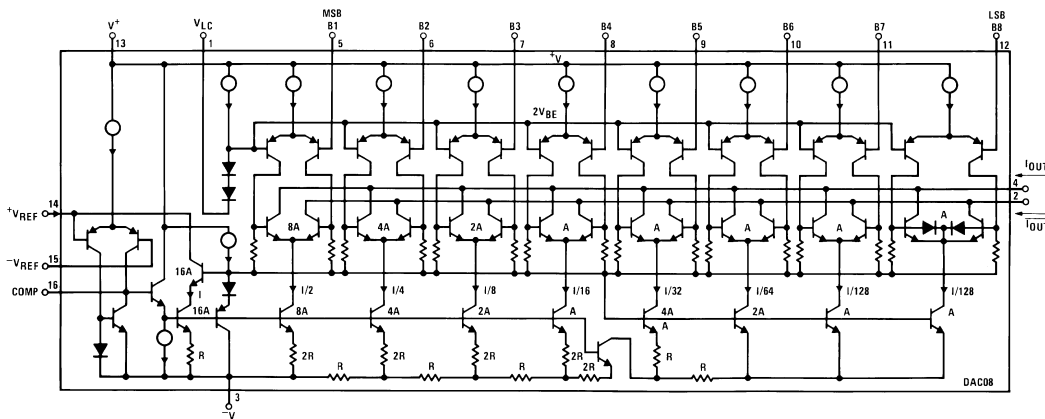

DS005686-15

FIGURE 2.

Typical Applications

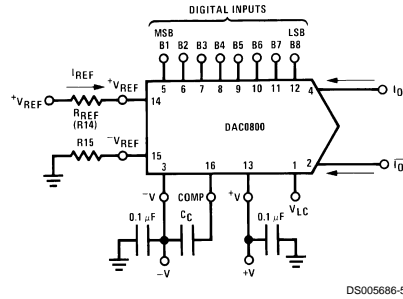

DS005686-5

$$I_{FS} \approx \frac{+V_{REF}}{R_{REF}} \times \frac{255}{256}$$

$I_O + \bar{I}_O = I_{FS}$ for all logic states

For fixed reference, TTL operation, typical values are:

$V_{REF} = 10.000V$

$R_{REF} = 5.000k$

$R15 = R_{REF}$

$C_C = 0.01 \mu F$

$V_{LC} = 0V$ (Ground)

FIGURE 3. Basic Positive Reference Operation (Note 5)

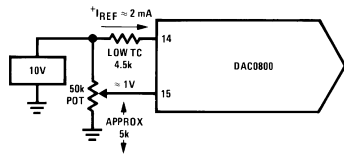

DS005686-21

FIGURE 4. Recommended Full Scale Adjustment Circuit (Note 5)

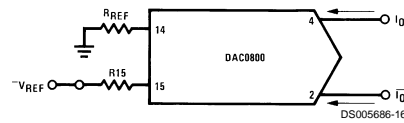

DS005686-16

$$I_{FS} \approx \frac{-V_{REF}}{R_{REF}} \times \frac{255}{256}$$

Note. R_{REF} sets I_{FS} ; $R15$ is for bias current cancellation

FIGURE 5. Basic Negative Reference Operation (Note 5)

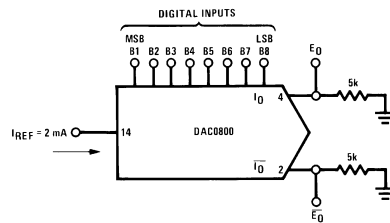

DS005686-17

	B1	B2	B3	B4	B5	B6	B7	B8	I_O mA	\bar{I}_O mA	E_O	\bar{E}_O
Full Scale	1	1	1	1	1	1	1	1	1.992	0.000	-9.960	0.000
Full Scale-LSB	1	1	1	1	1	1	1	0	1.984	0.008	-9.920	-0.040
Half Scale+LSB	1	0	0	0	0	0	0	1	1.008	0.984	-5.040	-4.920
Half Scale	1	0	0	0	0	0	0	0	1.000	0.992	-5.000	-4.960
Half Scale-LSB	0	1	1	1	1	1	1	1	0.992	1.000	-4.960	-5.000
Zero Scale+LSB	0	0	0	0	0	0	0	1	0.008	1.984	-0.040	-9.920
Zero Scale	0	0	0	0	0	0	0	0	0.000	1.992	0.000	-9.960

FIGURE 6. Basic Unipolar Negative Operation (Note 5)

Typical Applications (Continued)

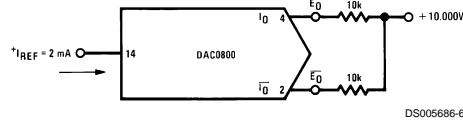

	B1	B2	B3	B4	B5	B6	B7	B8	E_O	\bar{E}_O
Pos. Full Scale	1	1	1	1	1	1	1	1	-9.920	+10.000
Pos. Full Scale-LSB	1	1	1	1	1	1	1	0	-9.840	+9.920
Zero Scale+LSB	1	0	0	0	0	0	0	1	-0.080	+0.160
Zero Scale	1	0	0	0	0	0	0	0	0.000	+0.080
Zero Scale-LSB	0	1	1	1	1	1	1	1	+0.080	0.000
Neg. Full Scale+LSB	0	0	0	0	0	0	0	1	+9.920	-9.840
Neg. Full Scale	0	0	0	0	0	0	0	0	+10.000	-9.920

FIGURE 7. Basic Bipolar Output Operation (Note 5)

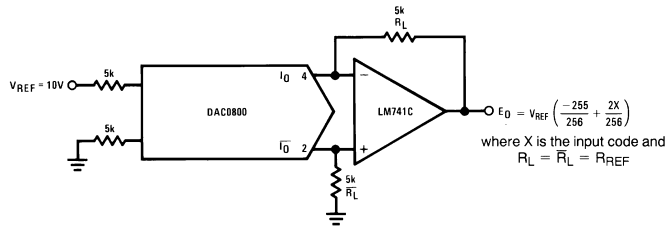

DS005686-18

If $R_L = \bar{R}_L$ within $\pm 0.05\%$, output is symmetrical about ground

	B1	B2	B3	B4	B5	B6	B7	B8	E_O
Pos. Full Scale	1	1	1	1	1	1	1	1	+9.960
Pos. Full Scale-LSB	1	1	1	1	1	1	1	0	+9.880
(+)Zero Scale	1	0	0	0	0	0	0	0	+0.040
(-)Zero Scale	0	1	1	1	1	1	1	1	-0.040
Neg. Full Scale+LSB	0	0	0	0	0	0	0	1	-9.880
Neg. Full Scale	0	0	0	0	0	0	0	0	-9.960

FIGURE 8. Symmetrical Offset Binary Operation (Note 5)

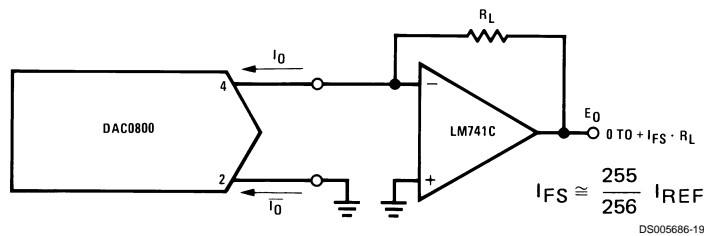

DS005686-19

For complementary output (operation as negative logic DAC), connect inverting input of op amp to \bar{I}_O (pin 2), connect I_O (pin 4) to ground.

FIGURE 9. Positive Low Impedance Output Operation (Note 5)

Physical Dimensions inches (millimeters) unless otherwise noted

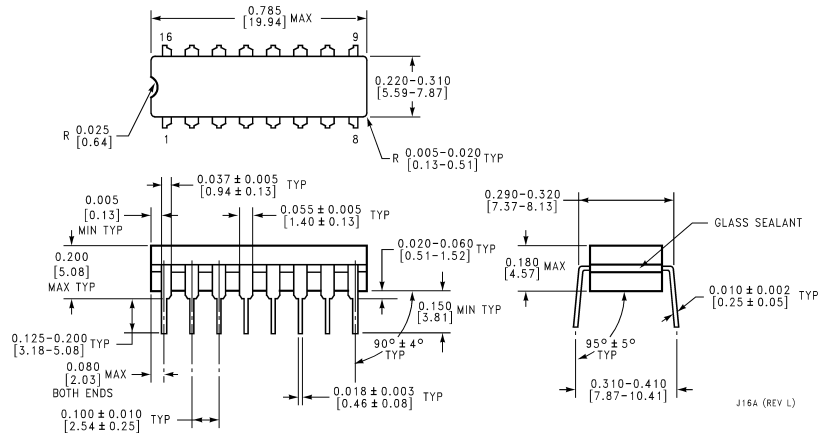

Molded Small Outline Package (SO)
Order Numbers DAC0800LCM,
or DAC0802LCM
NS Package Number M16A

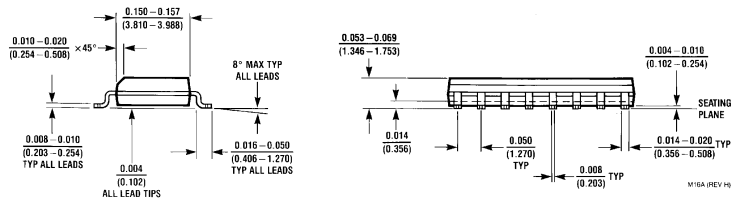
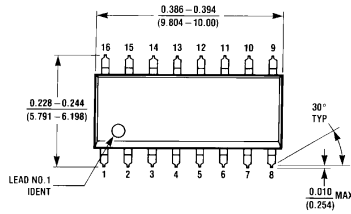

Molded Small Outline Package (SO)
Order Numbers DAC0800LCM,
or DAC0802LCM
NS Package Number M16A

Physical Dimensions inches (millimeters) unless otherwise noted (Continued)

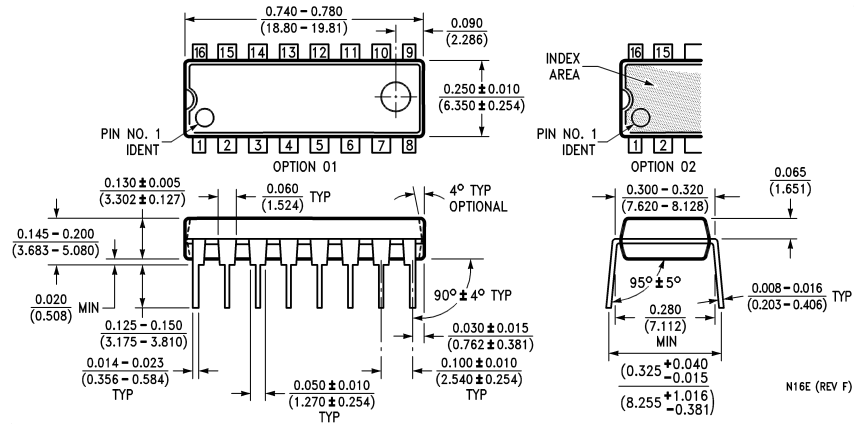

Molded Dual-In-Line Package
Order Numbers DAC0800, DAC0802
NS Package Number N16E

LIFE SUPPORT POLICY

NATIONAL'S PRODUCTS ARE NOT AUTHORIZED FOR USE AS CRITICAL COMPONENTS IN LIFE SUPPORT DEVICES OR SYSTEMS WITHOUT THE EXPRESS WRITTEN APPROVAL OF THE PRESIDENT AND GENERAL COUNSEL OF NATIONAL SEMICONDUCTOR CORPORATION. As used herein:

1. Life support devices or systems are devices or systems which, (a) are intended for surgical implant into the body, or (b) support or sustain life, and whose failure to perform when properly used in accordance with instructions for use provided in the labeling, can be reasonably expected to result in a significant injury to the user.
2. A critical component is any component of a life support device or system whose failure to perform can be reasonably expected to cause the failure of the life support device or system, or to affect its safety or effectiveness.

National Semiconductor Corporation
 Americas
 Tel: 1-800-272-9959
 Fax: 1-800-737-7018
 Email: support@nsc.com
 www.national.com

National Semiconductor Europe
 Fax: +49 (0) 1 80-530 85 86
 Email: europe.support@nsc.com
 Deutsch Tel: +49 (0) 1 80-530 85 85
 English Tel: +49 (0) 1 80-532 78 32
 Français Tel: +49 (0) 1 80-532 93 58
 Italiano Tel: +49 (0) 1 80-534 16 80

National Semiconductor Asia Pacific Customer Response Group
 Tel: 65-2544466
 Fax: 65-2504466
 Email: sea.support@nsc.com

National Semiconductor Japan Ltd.
 Tel: 81-3-5639-7560
 Fax: 81-3-5639-7507

National does not assume any responsibility for use of any circuitry described, no circuit patent licenses are implied and National reserves the right at any time without notice to change said circuitry and specifications.