

Z0103/07/09 series

Triacs

Rev. 02 — 12 September 2002

Product data

1. Product profile

1.1 Description

Passivated triacs in conventional and surface mounting packages. Intended for use in applications requiring high bidirectional transient and blocking voltage capability. Available in a range of gate current sensitivities for optimum performance.

Product availability:

Z0103MA; Z0103NA; Z0107MA; Z0107NA; Z0109MA; Z0109NA in SOT54B
Z0103MN; Z0103NN; Z0107MN; Z0107NN; Z0109MN; Z0109NN in SOT223.

1.2 Features





- Blocking voltage to 800 V (NA and NN types)
- 1 A on-state RMS current.

1.3 Applications

- Home appliances
- Fan controllers
- Small motor control
- Small loads in industrial process control.

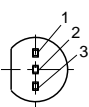
2. Pinning information

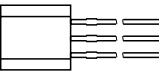
Table 1: Pinning - SOT54B (TO-92), SOT223, simplified outline and symbol

Pin	Description	Simplified outline	Symbol
1	terminal 2 (T2)		
2	gate (G)		
3	terminal 1 (T1)		
1	terminal 1 (T1)		
2	terminal 2 (T2)		
3	gate (G)		
4	terminal 2 (T2)		

SOT54B (TO-92) **SOT223**



PHILIPS

3. Ordering information

3.1 Ordering options

Table 2: Ordering information

Part Number	Voltage (V_{DRM})	Gate Sensitivity (I_{GT})	Package
Z0103MA	600 V	3 mA	SOT54B (TO-92)
Z0103NA	800 V	3 mA	SOT54B (TO-92)
Z0107MA	600 V	5 mA	SOT54B (TO-92)
Z0107NA	800 V	5 mA	SOT54B (TO-92)
Z0109MA	600 V	10 mA	SOT54B (TO-92)
Z0109NA	800 V	10 mA	SOT54B (TO-92)
Z0103MN	600 V	3 mA	SOT223
Z0103NN	800 V	3 mA	SOT223
Z0107MN	600 V	5 mA	SOT223
Z0107NN	800 V	5 mA	SOT223
Z0109MN	600 V	10 mA	SOT223
Z0109NN	800 V	10 mA	SOT223

4. Limiting values

Table 3: Limiting values

In accordance with the Absolute Maximum Rating System (IEC 60134).

Symbol	Parameter	Conditions	Min	Max	Unit
V_{DRM}	repetitive peak off-state voltage	$25\text{ °C} \leq T_j \leq 125\text{ °C}$			
	Z0103/07/09MA; Z0103/07/09MN		-	600	V
	Z0103/07/09NA; Z0103/07/09NN		-	800	V
V_{RRM}	repetitive peak reverse voltage	$25\text{ °C} \leq T_j \leq 125\text{ °C}$			
	Z0103/07/09MA; Z0103/07/09MN		-	600	V
	Z0103/07/09NA; Z0103/07/09NN		-	800	V
I_{TSM}	non-repetitive peak on-state current	full sine wave; $T_j = 25\text{ °C}$ prior to surge; Figure 2 and Figure 3			
		$t = 20\text{ ms}$	-	8	A
		$t = 16.7\text{ ms}$	-	8.5	A
$I_{T(RMS)}$	RMS on-state current	all conduction angles; Figure 4			
	SOT223	$T_{sp} = 90\text{ °C}$	-	1	A
	SOT54B (TO-92)	$T_{lead} = 50\text{ °C}$	-	1	A
I^2t	I^2t for fusing	$t = 10\text{ ms}$	-	0.35	A ² s
di_T/dt	rate of rise of on-state current	$I_{TM} = 1.0\text{ A}$; $I_G = 2 \times I_{GT}$; $dI_G/dt = 100\text{ mA}/\mu\text{s}$	-	20	A/ μs
I_{GM}	peak gate current	$t_p = 20\text{ }\mu\text{s}$	-	1.0	A
P_{GM}	peak gate power		-	2.0	W
$P_{G(AV)}$	average gate power	over any 20 ms period	-	0.1	W
T_{stg}	storage temperature		-40	+150	°C
T_j	junction temperature		-40	+125	°C

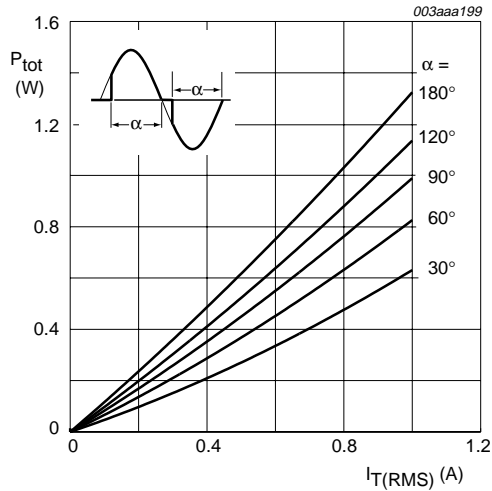

α = conduction angle

Fig 1. Maximum on-state power dissipation as a function of RMS on-state current; typical values.

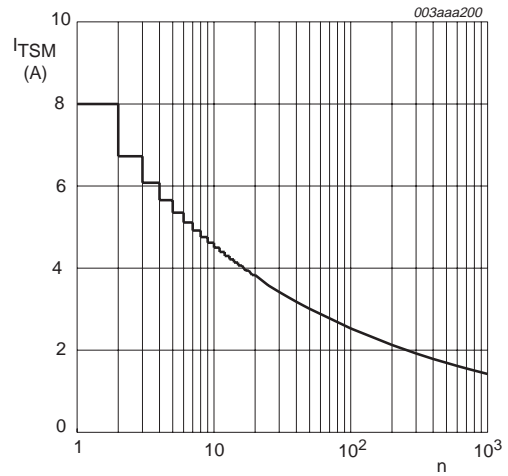

n = number of cycles at $f = 50$ Hz

Fig 2. Maximum permissible non-repetitive peak on-state current as a function of number of cycles for sinusoidal currents; typical values.

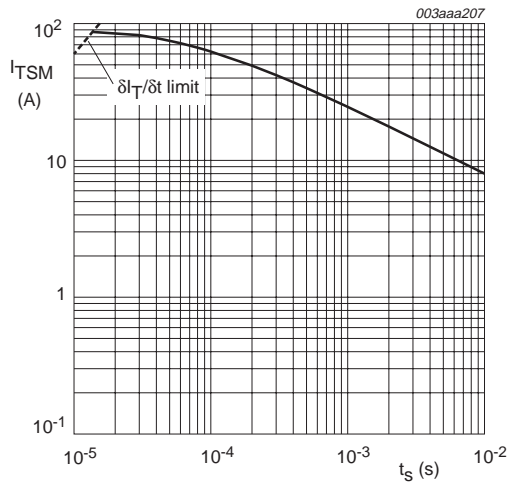

Fig 3. Maximum permissible non-repetitive peak on-state current as a function of surge duration for sinusoidal currents; typical values.

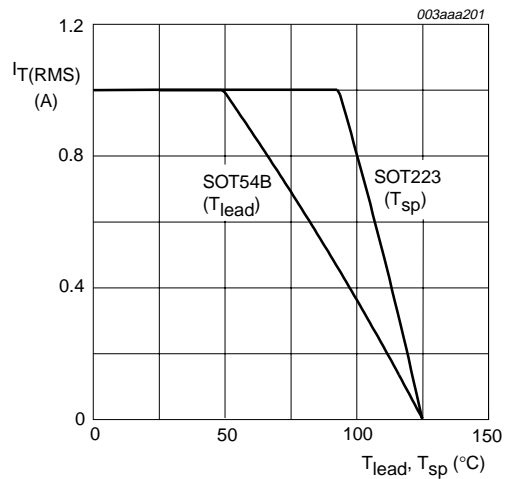

Fig 4. Maximum permissible RMS on-state current as a function of lead temperature and solder point temperature; typical values.

5. Thermal characteristics

Table 4: Thermal characteristics

Symbol	Parameter	Conditions	Min	Typ	Max	Unit
$R_{th(j-sp)}$	thermal resistance from junction to solder point for SOT223	Figure 5	-	-	25	K/W
$R_{th(j-lead)}$	thermal resistance from junction to lead for SOT54B (TO-92)	Figure 5	-	-	60	K/W
$R_{th(j-a)}$	SOT223	minimum footprint; mounted on a PCB	-	60	-	K/W
	SOT54B (TO-92)	vertical in free air	-	150	-	K/W

5.1 Transient thermal impedance

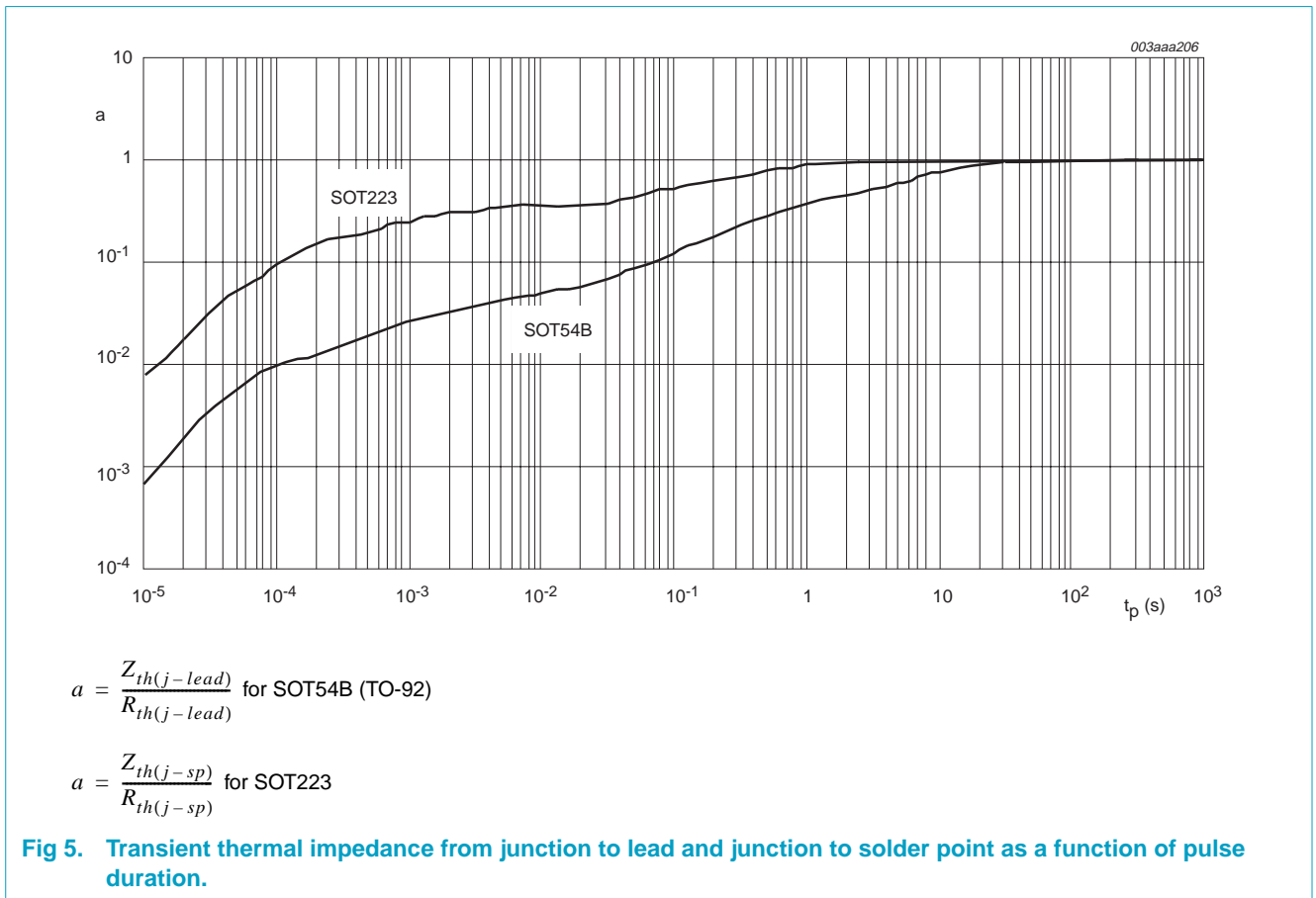

6. Characteristics

Table 5: Characteristics
 $T_j = 25\text{ °C}$ unless otherwise specified.

Symbol	Parameter	Conditions	Min	Typ	Max	Unit	
Static characteristics							
I_{GT}	gate trigger current	$V_D = 12\text{ V}$; $R_L = 30\ \Omega$; T2+ G+; T2+ G-; T2- G-; Figure 9	-	-	3	mA	
	Z0103MA/MN/NA/NN		-	-	5	mA	
	Z0107MA/MN/NA/NN		-	-	10	mA	
	Z0103MA/MN/NA/NN	$V_D = 12\text{ V}$; $R_L = 30\ \Omega$; T2- G+; Figure 9	-	-	5	mA	
	Z0107MA/MN/NA/NN		-	-	7	mA	
	Z0109MA/MN/NA/NN		-	-	10	mA	
I_L	latching current	$V_D = 12\text{ V}$; $R_L = 30\ \Omega$; T2+ G+; T2- G-; T2- G+; Figure 7	-	-	7	mA	
	Z0103MA/MN/NA/NN		-	-	10	mA	
	Z0107MA/MN/NA/NN		-	-	15	mA	
	Z0103MA/MN/NA/NN	$V_D = 12\text{ V}$; $R_L = 30\ \Omega$; T2+ G-; Figure 7	-	-	15	mA	
	Z0107MA/MN/NA/NN		-	-	20	mA	
	Z0109MA/MN/NA/NN		-	-	25	mA	
I_H	holding current	$I_T = 50\text{ mA}$; Figure 8	-	-	7	mA	
	Z0103MA/MN/NA/NN		-	-	10	mA	
	Z0109MA/MN/NA/NN		-	-	10	mA	
V_T	on-state voltage	Figure 6	-	1.3	1.6	V	
V_{GT}	gate trigger voltage	$V_D = 12\text{ V}$; $R_L = 30\ \Omega$; $T_j = 25\text{ °C}$; Figure 11	-	-	1.3	V	
		$V_D = V_{DRM}$; $R_L = 3.3\text{ k}\Omega$; $T_j = 125\text{ °C}$; Figure 11	0.2	-	-	V	
I_D	off-state leakage current	$V_D = V_{DRM(max)}$; $V_R = V_{RRM(max)}$; $T_j = 125\text{ °C}$	-	-	500	μA	
Dynamic characteristics							
dV_D/dt	critical rate of rise of off-state voltage	$V_D = 0.67 V_{DRM(max)}$; $T_j = 110\text{ °C}$; exponential waveform; gate open; Figure 10	10	-	-	V/ μs	
			Z0103MA/MN/NA/NN	20	-	-	V/ μs
			Z0107MA/MN/NA/NN	50	-	-	V/ μs
dV_{com}/dt	critical rate of change of commutating voltage	$V_D = 400\text{ V}$; $I_T = 1\text{ A}$; $T_j = 110\text{ °C}$; $dI_{com}/dt = 0.44\text{ A/ms}$; gate open	0.5	-	-	V/ μs	
			Z0103MA/MN/NA/NN	1	-	-	V/ μs
			Z0107MA/MN/NA/NN	2	-	-	V/ μs
Z0109MA/MN/NA/NN							

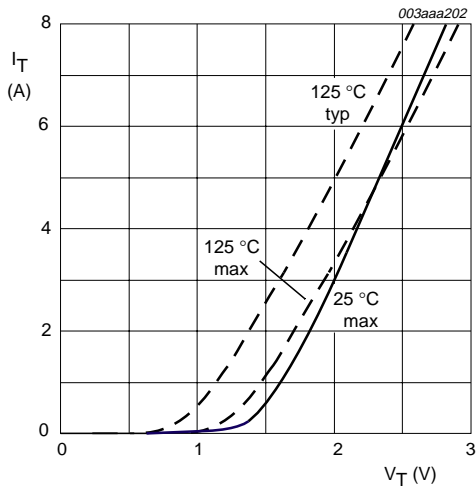
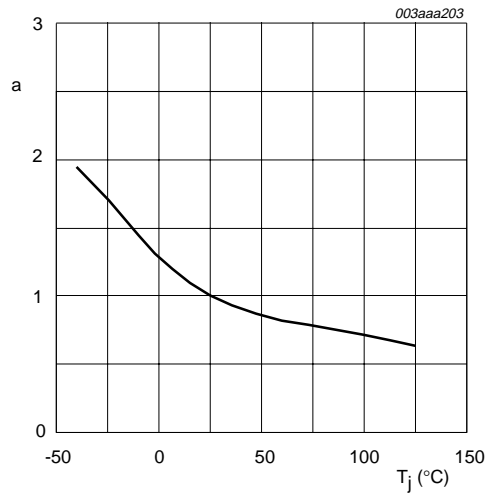
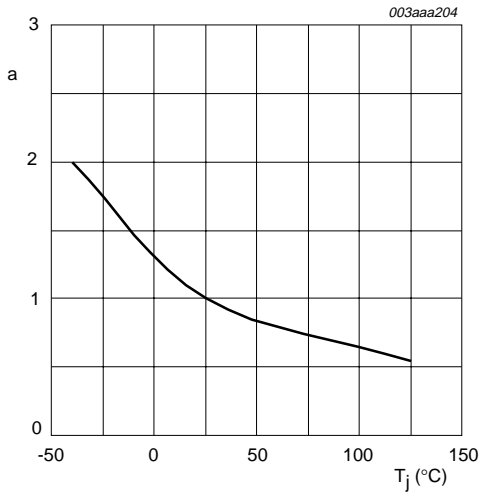

Fig 6. On-state current as a function of on-state voltage; typical and maximum values.



$$a = \frac{I_L}{I_{L(25^\circ\text{C})}}$$

Fig 7. Normalized latching current as a function of junction temperature; typical values.



$$a = \frac{I_H}{I_{H(25^\circ\text{C})}}$$

Fig 8. Normalized holding current as a function of junction temperature; typical values.

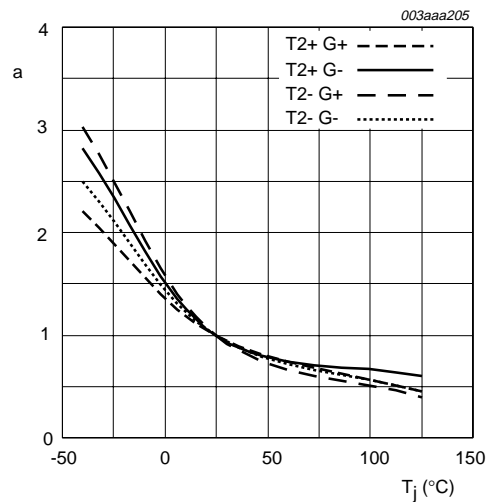

$$a = \frac{I_{GT}}{I_{GT(25^\circ\text{C})}}$$

Fig 9. Normalized gate trigger current as a function of junction temperature; typical values.

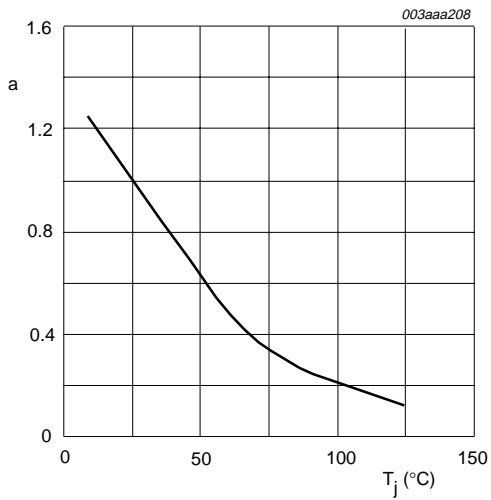

$$a = \frac{dV_D/dt}{dV_{D(25^\circ C)}/dt}$$

Fig 10. Normalized critical rate of rise of off-state voltage as a function of junction temperature; typical values.

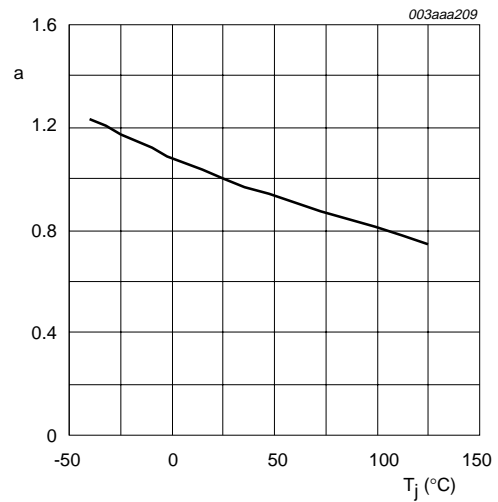

$$a = \frac{V_{GT}}{V_{GT(25^\circ C)}}$$

Fig 11. Normalized gate trigger voltage as a function of junction temperature; typical values.

7. Package outline

Plastic single-ended leaded (through hole) package; 3 leads

SOT54B

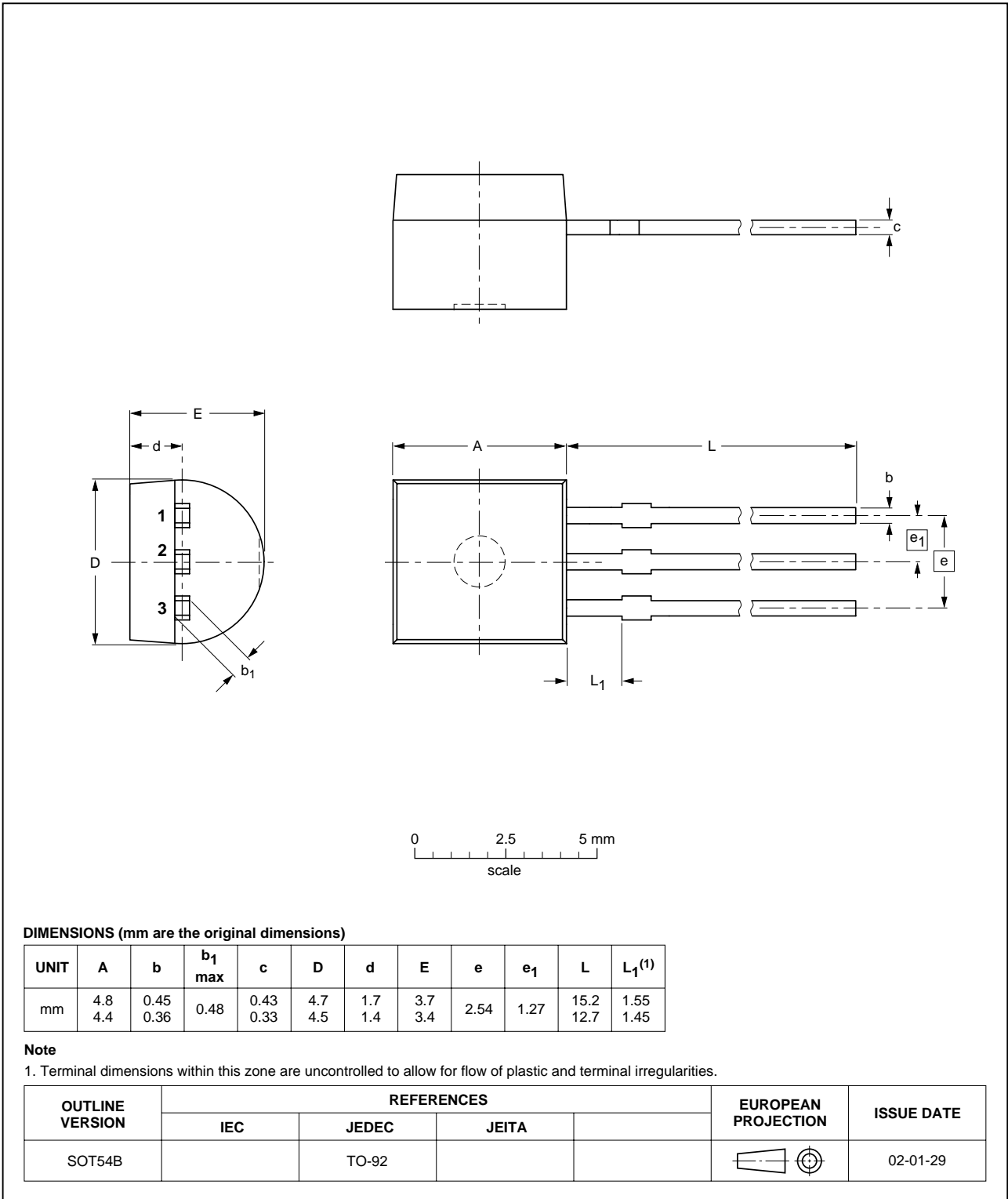

Fig 12. SOT54B (TO-92).

Plastic surface mounted package; collector pad for good heat transfer; 4 leads

SOT223

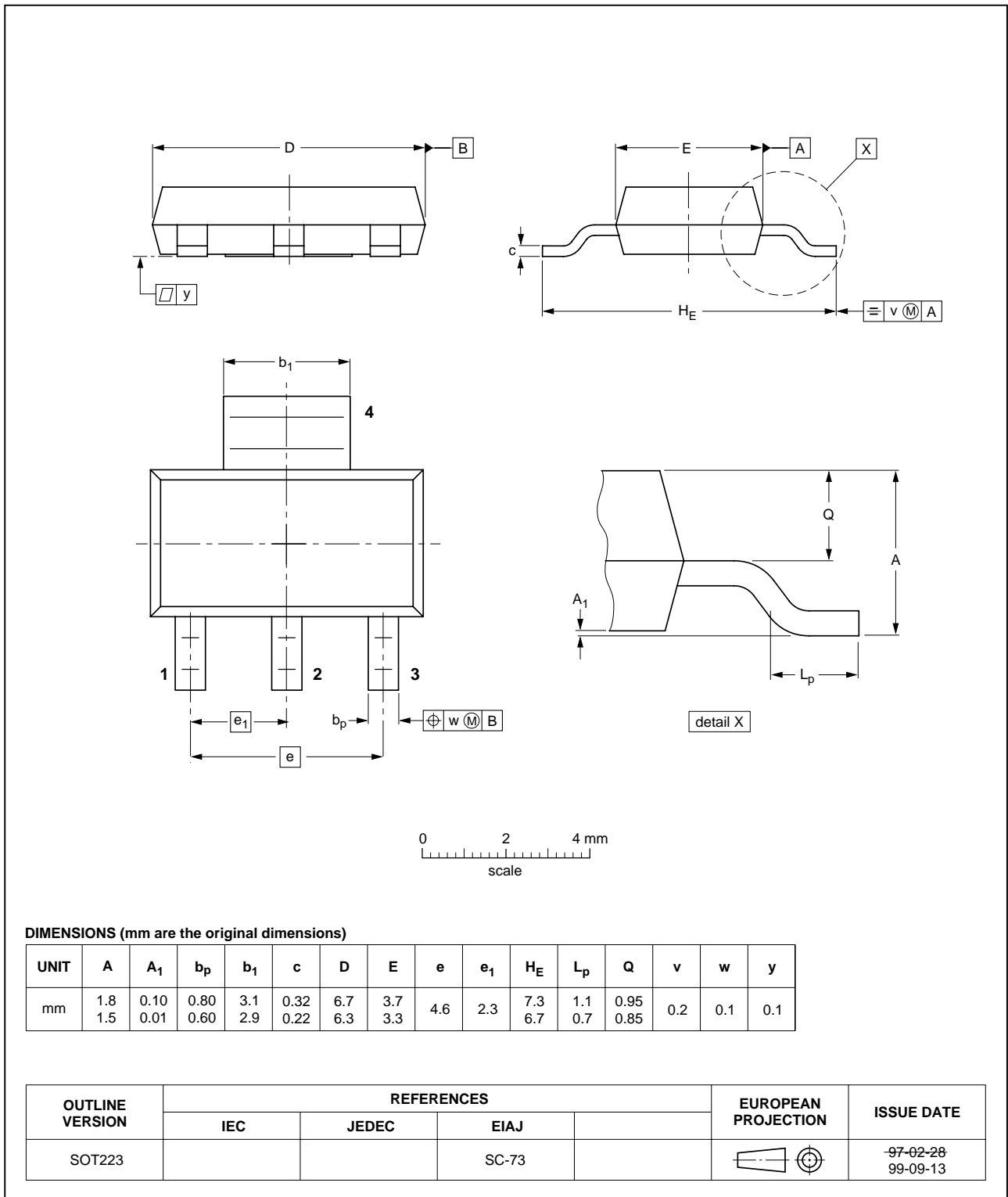

Fig 13. SOT223.

8. Revision history

Table 6: Revision history

Rev	Date	CPCN	Description
02	20020912		Product data; supersedes data of 11 April 2002 Table 5 "Characteristics" Addition of dV_{com}/dt data. Correction to dV_D/dt data
01	20020411	-	Product data; initial version (9397 750 09419)

9. Data sheet status

Data sheet status ^[1]	Product status ^[2]	Definition
Objective data	Development	This data sheet contains data from the objective specification for product development. Philips Semiconductors reserves the right to change the specification in any manner without notice.
Preliminary data	Qualification	This data sheet contains data from the preliminary specification. Supplementary data will be published at a later date. Philips Semiconductors reserves the right to change the specification without notice, in order to improve the design and supply the best possible product.
Product data	Production	This data sheet contains data from the product specification. Philips Semiconductors reserves the right to make changes at any time in order to improve the design, manufacturing and supply. Changes will be communicated according to the Customer Product/Process Change Notification (CPCN) procedure SNW-SQ-650A.

[1] Please consult the most recently issued data sheet before initiating or completing a design.

[2] The product status of the device(s) described in this data sheet may have changed since this data sheet was published. The latest information is available on the Internet at URL <http://www.semiconductors.philips.com>.

10. Definitions

Short-form specification — The data in a short-form specification is extracted from a full data sheet with the same type number and title. For detailed information see the relevant data sheet or data handbook.

Limiting values definition — Limiting values given are in accordance with the Absolute Maximum Rating System (IEC 60134). Stress above one or more of the limiting values may cause permanent damage to the device. These are stress ratings only and operation of the device at these or at any other conditions above those given in the Characteristics sections of the specification is not implied. Exposure to limiting values for extended periods may affect device reliability.

Application information — Applications that are described herein for any of these products are for illustrative purposes only. Philips Semiconductors make no representation or warranty that such applications will be suitable for the specified use without further testing or modification.

11. Disclaimers

Life support — These products are not designed for use in life support appliances, devices, or systems where malfunction of these products can reasonably be expected to result in personal injury. Philips Semiconductors customers using or selling these products for use in such applications do so at their own risk and agree to fully indemnify Philips Semiconductors for any damages resulting from such application.

Right to make changes — Philips Semiconductors reserves the right to make changes, without notice, in the products, including circuits, standard cells, and/or software, described or contained herein in order to improve design and/or performance. Philips Semiconductors assumes no responsibility or liability for the use of any of these products, conveys no licence or title under any patent, copyright, or mask work right to these products, and makes no representations or warranties that these products are free from patent, copyright, or mask work right infringement, unless otherwise specified.

Contact information

For additional information, please visit <http://www.semiconductors.philips.com>.

For sales office addresses, send e-mail to: sales.addresses@www.semiconductors.philips.com.

Fax: +31 40 27 24825

Contents

1	Product profile	1
1.1	Description	1
1.2	Features	1
1.3	Applications	1
2	Pinning information	1
3	Ordering information	2
3.1	Ordering options	2
4	Limiting values	2
5	Thermal characteristics	4
5.1	Transient thermal impedance	4
6	Characteristics	5
7	Package outline	8
8	Revision history	10
9	Data sheet status	11
10	Definitions	11
11	Disclaimers	11

© Koninklijke Philips Electronics N.V. 2002.
Printed in The Netherlands

All rights are reserved. Reproduction in whole or in part is prohibited without the prior written consent of the copyright owner.

The information presented in this document does not form part of any quotation or contract, is believed to be accurate and reliable and may be changed without notice. No liability will be accepted by the publisher for any consequence of its use. Publication thereof does not convey nor imply any license under patent- or other industrial or intellectual property rights.

Date of release: 12 September 2002

Document order number: 9397 750 10102



PHILIPS

Let's make things better.