



HIGH OUTPUT FULL-DUPLEX RS-485 DRIVERS AND RECEIVERS

FEATURES

- 1/8 Unit-Load Option Available (Up to 256 Nodes on the Bus)
- Bus-Pin ESD Protection Exceeds 15 kV HBM
- Optional Driver Output Transition Times for Signaling Rates ⁽¹⁾ of 1 Mbps, 5 Mbps and 25 Mbps
- Low-Current Standby Mode < 1 μ A
- Glitch-Free Power-Up and Power-Down Bus I/Os
- Bus Idle, Open, and Short Circuit Failsafe
- Meets or exceeds the requirements of ANSI TIA/EIA-485-A and RS-422 Compatible
- 3.3-V Devices available, SN65HVD30-39

APPLICATIONS

- Utility Meters
- Chassis-to-Chassis Interconnects
- DTE/DCE Interfaces
- Industrial, Process, and Building Automation
- Point-of-Sale (POS) Terminals and Networks

DESCRIPTION

The SN65HVD5X devices are 3-state differential line drivers and differential-input line receivers that operate with a 5-V power supply. Each driver and receiver has separate input and output pins for full-duplex bus communication designs. They are designed for balanced transmission lines and interoperability with ANSI TIA/EIA-485A, TIA/EIA-422-B, ITU-T v.11 and ISO 8482:1993 standard-compliant devices.

(1) The signaling rate of a line is the number of voltage transitions that are made per second expressed in the units bps (bits per second).

The SN65HVD50, SN65HVD51, SN65HVD52, SN65HVD56 and SN65HVD57 are fully enabled with no external enabling pins. The SN65HVD56 and SN65HVD57 implement receiver equalization technology for improved performance in long distance applications.

The SN65HVD53, SN65HVD54, SN65HVD55, SN65HVD58, and SN65HVD59 have active-high driver enables and active-low receiver enables. A very low, less than 1 μ A, standby current can be achieved by disabling both the driver and receiver. The SN65HVD58 and SN65HVD59 implement receiver equalization technology for improved performance in long distance applications.

All devices are characterized for operation from -40° C to +85°.

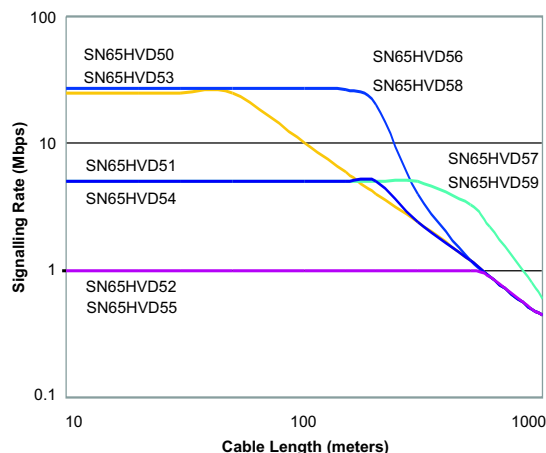

The SN65HVD56 and SN65HVD58 implement receiver equalization technology for improved jitter performance on differential bus applications with data rates up to 20 Mbps at cable lengths up to 160 meters.

The SN65HVD57 and SN65HVD59 implement receiver equalization technology for improved jitter performance on differential bus applications with data rates in the range of 1 to 5 Mbps at cable lengths up to 1000 meters.



Please be aware that an important notice concerning availability, standard warranty, and use in critical applications of Texas Instruments semiconductor products and disclaimers thereto appears at the end of this data sheet.



These devices have limited built-in ESD protection. The leads should be shorted together or the device placed in conductive foam during storage or handling to prevent electrostatic damage to the MOS gates.

**SN65HVD50, SN65HVD51, SN65HVD52, SN65HVD56,
SN65HVD57**

D PACKAGE (TOP VIEW)

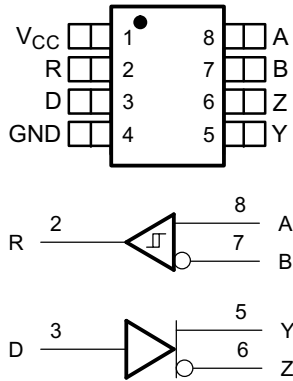

**SN65HVD53, SN65HVD54, SN65HVD55, SN65HVD58,
SN65HVD59**

D PACKAGE (TOP VIEW)

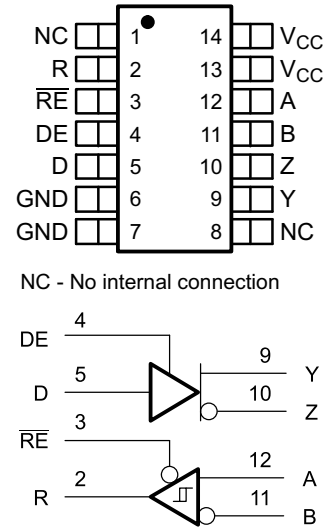

NC - No internal connection

AVAILABLE OPTIONS

SIGNALING RATE	UNIT LOADS	RECEIVER EQUALIZATION	ENABLES	BASE PART NUMBER	SOIC MARKING
25 Mbps	1/2	No	No	SN65HVD50	PREVIEW
5 Mbps	1/8	No	No	SN65HVD51	PREVIEW
1 Mbps	1/8	No	No	SN65HVD52	PREVIEW
25 Mbps	1/2	No	Yes	SN65HVD53	65HVD53
5 Mbps	1/8	No	Yes	SN65HVD54	65HVD54
1 Mbps	1/8	No	Yes	SN65HVD55	65HVD55
25 Mbps	1/2	Yes	No	SN65HVD56	PREVIEW
5 Mbps	1/8	Yes	No	SN65HVD57	PREVIEW
25 Mbps	1/2	Yes	Yes	SN65HVD58	PREVIEW
5 Mbps	1/8	Yes	Yes	SN65HVD59	PREVIEW

ABSOLUTE MAXIMUM RATINGS

over operating free-air temperature range (unless otherwise noted)⁽¹⁾⁽²⁾

		UNIT
V_{CC}	Supply voltage range	–0.3 V to 6 V
	Voltage range at any bus terminal (A, B, Y, Z)	–9 V to 14 V
	Voltage input, transient pulse through 100 Ω . See Figure 12 (A, B, Y, Z) ⁽³⁾	–50 to 50 V
V_I	Voltage input range (D, DE, \overline{RE})	–0.5 V to 7 V
	Continuous total power dissipation	Internally limited
I_O	Output current (receiver output only, R)	11 mA

- (1) Stresses beyond those listed under absolute maximum ratings may cause permanent damage to the device. These are stress ratings only, and functional operation of the device at these or any other conditions beyond those indicated under recommended operating conditions is not implied. Exposure to absolute-maximum-rated conditions for extended periods may affect device reliability.
- (2) All voltage values, except differential I/O bus voltages, are with respect to network ground terminal.
- (3) This tests survivability only and the output state of the receiver is not specified.

RECOMMENDED OPERATING CONDITIONS

over operating free-air temperature range (unless otherwise noted)

PARAMETER		MIN	NOM	MAX	UNIT
V_{CC}	Supply voltage	4.5		5.5	
V_I or V_{IC}	Voltage at any bus terminal (separately or common mode)	–7 ⁽¹⁾		12	V
$1/t_{UI}$	Signaling rate	SN65HVD50, SN65HVD53, SN65HVD56, SN65HVD58		25	Mbps
		SN65HVD51, SN65HVD54, SN65HVD57, SN65HVD59		5	
		SN65HVD52, SN65HVD55		1	
R_L	Differential load resistance	54	60		Ω
V_{IH}	High-level input voltage			V_{CC}	
V_{IL}	Low-level input voltage			0.8	V
V_{ID}	Differential input voltage	–12		12	
I_{OH}	High-level output current	Driver	–60		mA
		Receiver	–8		
I_{OL}	Low-level output current	Driver		60	mA
		Receiver		8	
T_J ⁽²⁾	Junction temperature	–40		150	$^{\circ}\text{C}$

- (1) The algebraic convention, in which the least positive (most negative) limit is designated as minimum is used in this data sheet.
- (2) See thermal characteristics table for information regarding this specification.

ELECTROSTATIC DISCHARGE PROTECTION

PARAMETER	TEST CONDITIONS	MIN	TYP ⁽¹⁾	MAX	UNIT
Human body model	Bus terminals and GND		± 16		kV
Human body model ⁽²⁾	All pins		± 4		
Charged-device-model ⁽³⁾	All pins		± 1		

- (1) All typical values at 25 $^{\circ}\text{C}$ and with a 5-V supply.
- (2) Tested in accordance with JEDEC Standard 22, Test Method A114-A.
- (3) Tested in accordance with JEDEC Standard 22, Test Method C101.

DRIVER ELECTRICAL CHARACTERISTICS

over recommended operating conditions unless otherwise noted

PARAMETER		TEST CONDITIONS	MIN	TYP ⁽¹⁾	MAX	UNIT
$V_{I(K)}$	Input clamp voltage	$I_I = -18$ mA	-1.5			V
$ V_{OD(SS)} $	Steady-state differential output voltage	$I_O = 0$		4	V_{CC}	
		$R_L = 54 \Omega$, See Figure 1 (RS-485)	1.7	2.6		
		$R_L = 100 \Omega$, See Figure 1 (RS-422)	2.4	3.2		
		$V_{test} = -7$ V to 12 V, See Figure 2	1.6			
$\Delta V_{OD(SS)} $	Change in magnitude of steady-state differential output voltage between states	$R_L = 54 \Omega$, See Figure 1 and Figure 2	-0.2		0.2	
$V_{OD(RING)}$	Differential Output Voltage overshoot and undershoot	$R_L = 54 \Omega$, $C_L = 50$ pF, See Figure 5 See Figure 3 for definition			0.05 $ V_{OD(SS)} $	
$V_{OC(PP)}$	Peak-to-peak common-mode output voltage	HVD50, HVD53, HVD56, HVD58	See Figure 4		0.5	
		HVD51, HVD54, HVD57, HVD59			0.4	
		HVD52, HVD55			0.4	
$V_{OC(SS)}$	Steady-state common-mode output voltage	See Figure 4	2.2		3.3	
$\Delta V_{OC(SS)}$	Change in steady-state common-mode output voltage	See Figure 4	-0.1		0.1	
$I_{Z(Z)}$ or $I_{Y(Z)}$	High-impedance state output current		$V_{CC} = 0$ V, V_Z or $V_Y = 12$ V, Other input at 0 V		90	
			$V_{CC} = 0$ V, V_Z or $V_Y = -7$ V, Other input at 0 V		-10	
		HVD53, HVD54, HVD55, HVD58, HVD59	$V_{CC} = 5$ V or 0 V, DE = 0 V, V_Z or $V_Y = 12$ V		Other input at 0 V	90
			$V_{CC} = 5$ V or 0 V, DE = 0 V, V_Z or $V_Y = -7$ V			-10
$I_{Z(S)}$ or $I_{Y(S)}$	Short Circuit output Current	V_Z or $V_Y = -7$ V		Other input at 0 V	-250	mA
		V_Z or $V_Y = 12$ V			-250	
I_I	Input current	D, DE	0		100	μ A
$C_{(OD)}$	Differential output capacitance	$V_{OD} = 0.4 \sin(4E6\pi t) + 0.5$ V, DE at 0 V		16		pF

(1) All typical values are at 25°C and with a 5-V supply.

DRIVER SWITCHING CHARACTERISTICS

over recommended operating conditions unless otherwise noted

PARAMETER		TEST CONDITIONS	MIN	TYP ⁽¹⁾	MAX	UNIT
t_{PLH}	Propagation delay time, low-to-high-level output	HVD50, HVD53, HVD56, HVD58	4	8	12	ns
		HVD51, HVD54, HVD57, HVD59	20	29	46	
		HVD52, HVD55	90	143	230	
t_{PHL}	Propagation delay time, high-to-low-level output	HVD50, HVD53, HVD56, HVD58	4	8	12	ns
		HVD51, HVD54, HVD57, HVD59	20	30	46	
		HVD52, HVD55	90	143	230	
t_r	Differential output signal rise time	HVD50, HVD53, HVD56, HVD58	3	6	12	ns
		HVD51, HVD54, HVD57, HVD59	25	34	60	
		HVD52, HVD55	130	197	300	
t_f	Differential output signal fall time	HVD50, HVD53, HVD56, HVD58	3	6	11	ns
		HVD51, HVD54, HVD57, HVD59	25	33	60	
		HVD52, HVD55	130	192	300	
$t_{sk(p)}$	Pulse skew ($ t_{PHL} - t_{PLH} $)	HVD50, HVD53, HVD56, HVD58			2	ns
		HVD51, HVD54, HVD57, HVD59			2	
		HVD52, HVD55			8	
$t_{sk(pp)}^{(2)}$	Part-to-part skew	HVD50, HVD53, HVD56, HVD58		1		ns
		HVD51, HVD54, HVD57, HVD59		4		
		HVD52, HVD55		22		
t_{PZH1}	Propagation delay time, high-impedance-to-high-level output	HVD53, HVD58			30	ns
		HVD54, HVD59			180	
		HVD55			380	
t_{PHZ}	Propagation delay time, high-level-to-high-impedance output	HVD53, HVD58			16	ns
		HVD54, HVD59			40	
		HVD55			110	
t_{PZL1}	Propagation delay time, high-impedance-to-low-level output	HVD53, HVD58			23	ns
		HVD54, HVD59			200	
		HVD55			420	
t_{PLZ}	Propagation delay time, low-level-to-high-impedance output	HVD53, HVD58			19	ns
		HVD54, HVD59			70	
		HVD55			160	
t_{PZH2}	Propagation delay time, standby-to-high-level output	$R_L = 110 \Omega$, \overline{RE} at 3 V, See Figure 6 $D = 3 \text{ V}$ and $S1 = Y$, $D = 0 \text{ V}$ and $S1 = Z$			3300	ns
t_{PZL2}	Propagation delay time, standby-to-low-level output	$R_L = 110 \Omega$, \overline{RE} at 3 V, See Figure 7 $D = 3 \text{ V}$ and $S1 = Z$, $D = 0 \text{ V}$ and $S1 = Y$			3300	ns

(1) All typical values are at 25°C and with a 5-V supply.

(2) $t_{sk(pp)}$ is the magnitude of the difference in propagation delay times between any specified terminals of two devices when both devices operate with the same supply voltages, at the same temperature, and have identical packages and test circuits.

RECEIVER ELECTRICAL CHARACTERISTICS

over recommended operating conditions unless otherwise noted

PARAMETER		TEST CONDITIONS	MIN	TYP ⁽¹⁾	MAX	UNIT	
V_{IT+}	Positive-going differential input threshold voltage	$I_O = -8$ mA			-0.02	V	
V_{IT-}	Negative-going differential input threshold voltage	$I_O = 8$ mA	-0.20				
V_{hys}	Hysteresis voltage ($V_{IT+} - V_{IT-}$)			50		mV	
V_{IK}	Enable-input clamp voltage	$I_I = -18$ mA	-1.5			V	
V_O	Output voltage	$V_{ID} = 200$ mV, $I_O = -8$ mA, See Figure 8	4.0			V	
		$V_{ID} = -200$ mV, $I_O = 8$ mA, See Figure 8			0.3		
$I_{O(Z)}$	High-impedance-state output current	$V_O = 0$ or $V_{CC}\overline{RE}$ at V_{CC}	-1		1	μ A	
I_A or I_B	Bus input current	HVD50, HVD53, HVD56, HVD58	Other input at 0 V	V_A or $V_B = 12$ V	0.19	0.3	mA
				V_A or $V_B = 12$ V, $V_{CC} = 0$ V	0.24	0.4	
				V_A or $V_B = -7$ V	-0.35	-0.19	
				V_A or $V_B = -7$ V, $V_{CC} = 0$ V	-0.25	-0.14	
		HVD51, HVD52, HVD54, HVD55, HVD57, HVD59	Other input at 0 V	V_A or $V_B = 12$ V	0.05	0.10	mA
				V_A or $V_B = 12$ V, $V_{CC} = 0$ V	0.06	0.10	
				V_A or $V_B = -7$ V	-0.10	-0.05	
				V_A or $V_B = -7$ V, $V_{CC} = 0$ V	-0.10	-0.03	
I_{IH}	Input current, \overline{RE}	$V_{IH} = 2$ V	-60			μ A	
		$V_{IL} = 0.8$ V	-60			μ A	
C_{ID}	Differential input capacitance	$V_{ID} = 0.4 \sin(4E6\pi t) + 0.5$ V, DE at 0 V		16		pF	
I_{CC}	Supply current	HVD50, HVD51, HVD52	D at 0 V or V_{CC} and No Load		8.0	mA	
				HVD56, HVD57	9.5		
				HVD53	2.3		
				HVD54, HVD55	2.9		
				HVD58, HVD59	4.5		
	HVD53, HVD54, HVD55, HVD58, HVD59	\overline{RE} at V_{CC} , D at V_{CC} , DE at 0 V, No load (Receiver disabled and driver disabled)		0.08	1	μ A	
			HVD53, HVD54, HVD55, HVD58, HVD59	\overline{RE} at 0 V, D at 0 V or V_{CC} , DE at V_{CC} , No load (Receiver enabled and driver enabled)	HVD53	2.7	mA
					HVD54, HVD55	8.0	
					HVD58	4.3	
					HVD59	9.7	
HVD53, HVD54, HVD55, HVD58, HVD59	\overline{RE} at V_{CC} , D at 0 V or V_{CC} , DE at V_{CC} , No load (Receiver disabled and driver enabled)	HVD53	2.3				
HVD54, HVD55	7.7						
HVD58	3.2						
HVD59	8.5						

(1) All typical values are at 25°C and with a 5-V supply.

RECEIVER SWITCHING CHARACTERISTICS

over recommended operating conditions unless otherwise noted

PARAMETER		TEST CONDITIONS	MIN	TYP ⁽¹⁾	MAX	UNIT
t _{PLH}	Propagation delay time, low-to-high-level output	HVD50, HVD53, HVD56, HVD58		24	40	ns
		HVD51, HVD52, HVD54, HVD55, HVD57, HVD59		43	55	
t _{PHL}	Propagation delay time, high-to-low-level output	HVD50, HVD53, HVD56, HVD58		26	35	
		HVD51, HVD52, HVD54, HVD55, HVD57, HVD59		47	60	
t _{sk(p)}	Pulse skew (t _{PHL} - t _{PLH})	HVD50, HVD53, HVD56, HVD57, HVD58, HVD59	V _{ID} = -1.5 V to 1.5 V, C _L = 15 pF, See Figure 9		5	
		HVD51, HVD54, HVD52, HVD55			7	
t _{sk(pp)} ⁽²⁾	Part-to-part skew	HVD50, HVD53, HVD56, HVD58		5		
		HVD51, HVD54, HVD57, HVD59		6		
		HVD52, HVD55		6		
t _r	Output signal rise time			2.3	4	
t _f	Output signal fall time			2.4	4	
t _{PHZ}	Output disable time from high level	DE at 3 V, C _L = 15 pF See Figure 10			17	
t _{PZH1}	Output enable time to high level				10	
t _{PZH2}	Propagation delay time, standby-to-high-level output	DE at 0 V, C _L = 15 pF See Figure 10			3300	
t _{PLZ}	Output disable time from low level	DE at 3 V, C _L = 15 pF See Figure 11			13	
t _{PZL1}	Output enable time to low level				10	
t _{PZL2}	Propagation delay time, standby-to-low-level output	DE at 0 V, C _L = 15 pF See Figure 11			3300	

(1) All typical values are at 25°C and with a 5-V supply

 (2) t_{sk(pp)} is the magnitude of the difference in propagation delay times between any specified terminals of two devices when both devices operate with the same supply voltages, at the same temperature, and have identical packages and test circuits.

RECEIVER EQUALIZATION CHARACTERISTICS

over recommended operating conditions unless otherwise noted⁽¹⁾

PARAMETER		TEST CONDITIONS			MIN	TYP ⁽²⁾	MAX	UNIT
$t_{j(pp)}$	Peak-to-peak eye-pattern jitter	Pseudo-random NRZ code with a bit pattern length o 216-1, Belden 3105A cable	25 Mbps	0 m	HVD56, HVD58	PREVIEW		ns
				100 m	HVD53	PREVIEW		
						HVD56, HVD58	PREVIEW	
				150 m	HVD53	PREVIEW		
						HVD56, HVD58	PREVIEW	
				200 m	HVD53	PREVIEW		
					HVD56, HVD58	PREVIEW		
			10 Mbps	200 m	HVD53	PREVIEW		
						HVD56, HVD58	PREVIEW	
				250 m	HVD53	PREVIEW		
						HVD56, HVD58	PREVIEW	
				300 m	HVD53	PREVIEW		
						HVD56, HVD58	PREVIEW	
			5 Mbps	500 m	HVD54	PREVIEW		
						HVD57, HVD59	PREVIEW	
			3 Mbps	500 m	HVD53	PREVIEW		
					HVD54	PREVIEW		
					HVD56, HVD58	PREVIEW		
					HVD57, HVD59	PREVIEW		
			1 Mbps	1000 m	HVD54	PREVIEW		
	HVD57, HVD59	PREVIEW						

(1) The HVD53 and HVD54 do not have receiver equalization but are specified for comparison.

(2) All typical values are at $V_{CC} = 5\text{ V}$, and temperature = 25°C.

THERMAL CHARACTERISTICS

over operating free-air temperature range unless otherwise noted⁽¹⁾

PARAMETER		TEST CONDITIONS		MIN	TYP	MAX	UNIT
θ_{JA}	Junction-to-ambient thermal resistance ⁽²⁾	Low-K board ⁽³⁾ , No airflow	HVD50, HVD51, HVD52, HVD56, HVD57		230.8		°C/W
			HVD53, HVD54, HVD55, HVD58, HVD59		162.6		
	Junction-to-ambient thermal resistance ⁽²⁾	High-K board ⁽⁴⁾ , No airflow	HVD50, HVD51, HVD52, HVD56, HVD57		135.1		
			HVD53, HVD54, HVD55, HVD58, HVD59		92.1		
θ_{JB}	Junction-to-board thermal resistance	High-K board	HVD50, HVD51, HVD52, HVD56, HVD57		44.4		
			HVD53, HVD54, HVD55, HVD58, HVD59		61.1		
θ_{JC}	Junction-to-case thermal resistance	No board	HVD50, HVD51, HVD52, HVD56, HVD57		43.5		
			HVD53, HVD54, HVD55, HVD58, HVD59		58.6		
P_D	Device power dissipation	$R_L = 60\Omega$, $C_L = 50$ pF, Input to D a 50% duty cycle square wave at indicated signaling rate	HVD50, HVD56 (25Mbps)			420	mW
			HVD51, HVD57 (10Mbps)			404	
			HVD52 (1Mbps)			383	
		$R_L = 60\Omega$, $C_L = 50$ pF, DE at $V_{CC}RE$ at 0 V, Input to D a 50% duty cycle square wave at indicated signaling rate	HVD53, HVD58 (25Mbps)			420	
			HVD54, HVD59 (10Mbps)			404	
			HVD55 (1Mbps)			383	
T_A	Ambient air temperature	Low-K board, No airflow	HVD50, HVD56	-40		55	°C
			HVD51, HVD52, HVD57	-40		84	
			HVD53, HVD54, HVD55, HVD58, HVD59	-40		85	
		High-K board, No airflow	HVD50, HVD51, HVD52, HVD56, HVD57	-40		85	
			HVD53, HVD54, HVD55, HVD58, HVD59	-40		85	
T_{JSD}	Thermal shutdown junction temperature				165		

- (1) See *Application Information* section for an explanation of these parameters.
- (2) The intent of θ_{JA} specification is solely for a thermal performance comparison of one package to another in a standardized environment. This methodology is not meant to and will not predict the performance of a package in an application-specific environment.
- (3) In accordance with the Low-K thermal metric definitions of EIA/JESD51-3.
- (4) In accordance with the High-K thermal metric definitions of EIA/JESD51-7.

PARAMETER MEASUREMENT INFORMATION

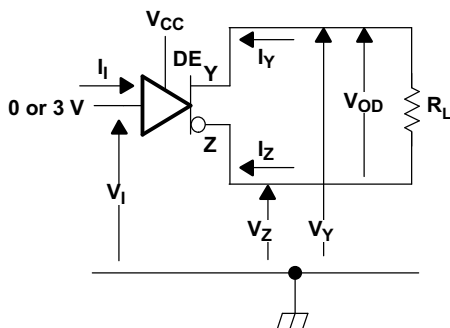

Figure 1. Driver V_{OD} Test Circuit: Voltage and Current Definitions

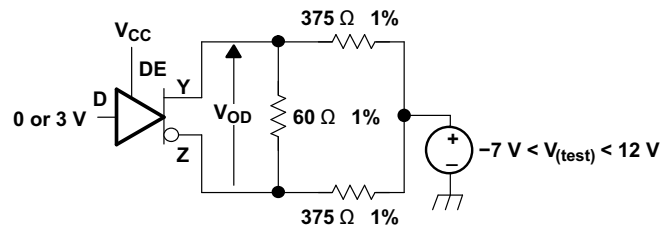

Figure 2. Driver V_{OD} With Common-Mode Loading Test Circuit

PARAMETER MEASUREMENT INFORMATION (continued)

VOD(RING) is measured at four points on the output waveform, corresponding to overshoot and undershoot from the VOD(H) and VOD(L) steady state values.

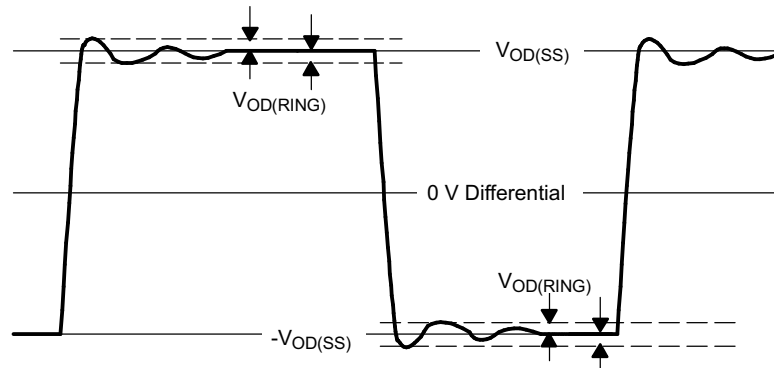

Figure 3. V_{OD(RING)} Waveform and Definitions

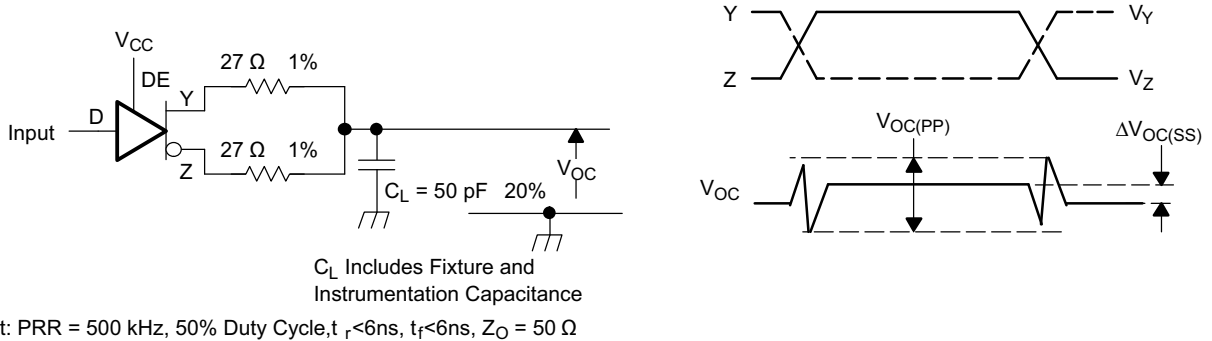

Figure 4. Test Circuit and Definitions for the Driver Common-Mode Output Voltage

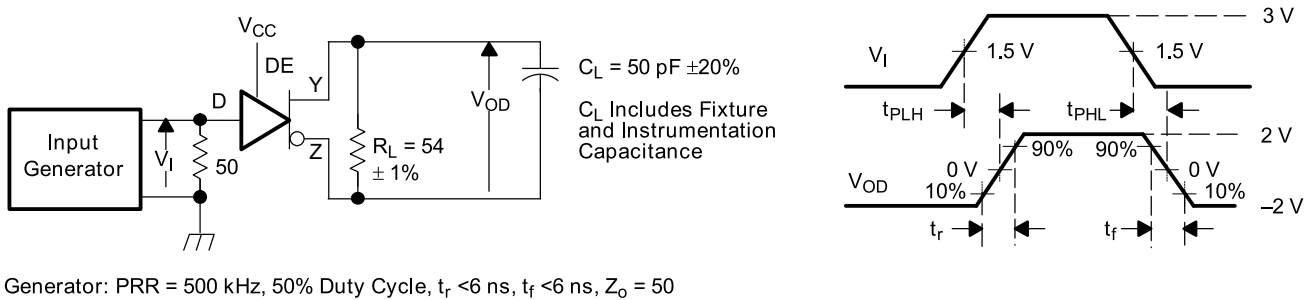

Figure 5. Driver Switching Test Circuit and Voltage Waveforms

PARAMETER MEASUREMENT INFORMATION (continued)

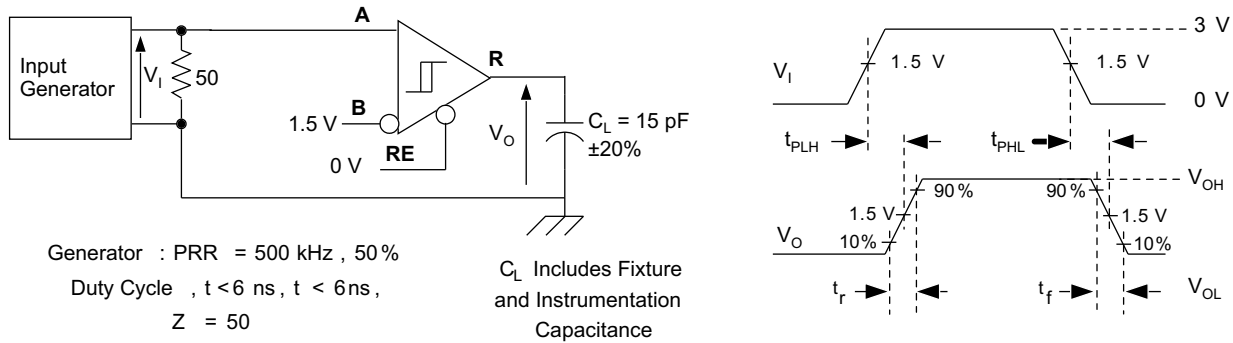

Figure 9. Receiver Switching Test Circuit and Voltage Waveforms

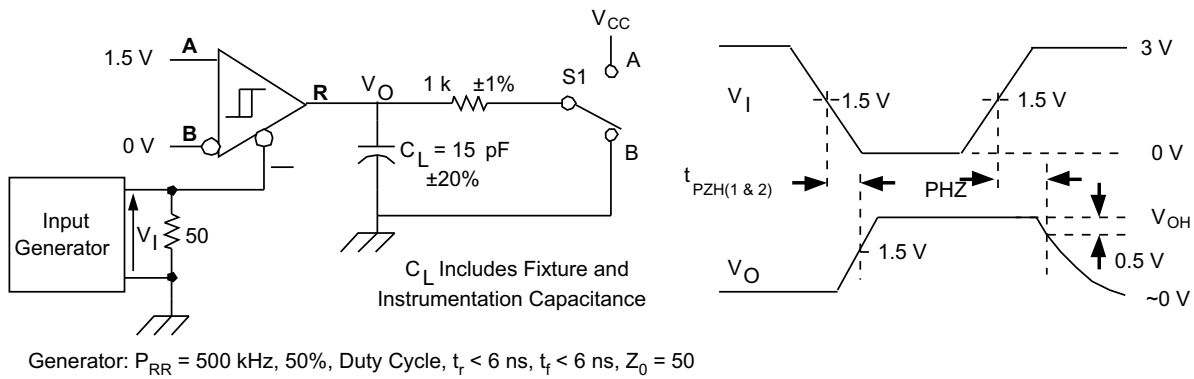

Figure 10. Receiver High-Level Enable and Disable Time Test Circuit and Voltage Waveforms

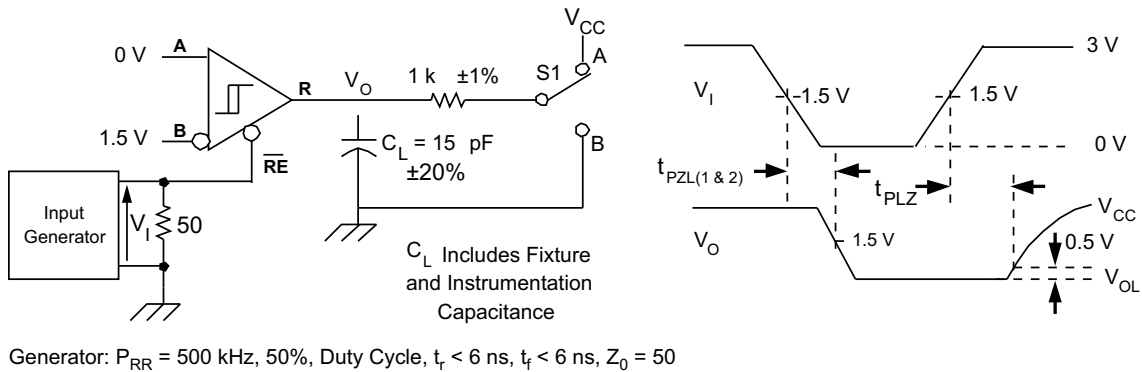

Figure 11. Receiver Low-Level Enable and Disable Time Test Circuit and Voltage Waveforms

PARAMETER MEASUREMENT INFORMATION (continued)

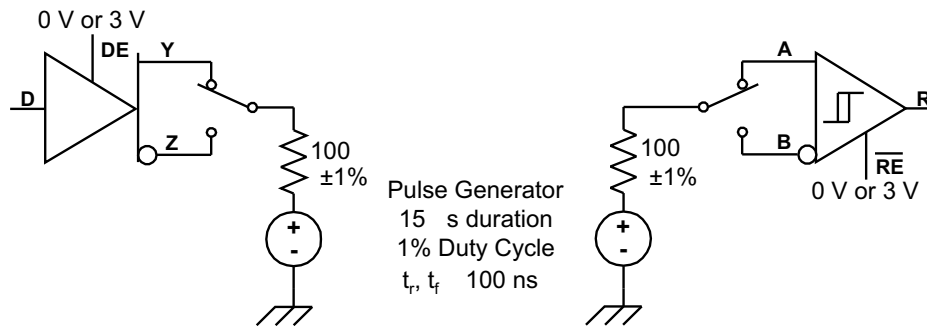

Figure 12. Test Circuit, Transient Overvoltage Test

DEVICE INFORMATION

LOW-POWER SHUTDOWN MODE

When both the driver and receiver are disabled (\overline{DE} low and \overline{RE} high) the device is in shutdown mode. If the enable inputs are in this state for less than 60 ns, the device does not enter shutdown mode. This guards against inadvertently entering shutdown mode during driver/receiver enabling. Only when the enable inputs are held in this state for 300 ns or more, the device is assured to be in shutdown mode. In this low-power shutdown mode, most internal circuitry is powered down, and the supply current is typically less than 1 nA. When either the driver or the receiver is re-enabled, the internal circuitry becomes active.

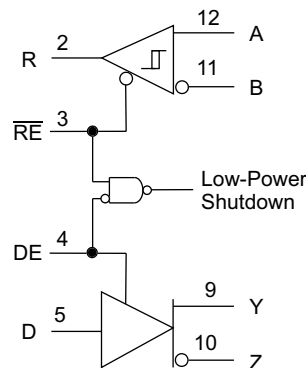

Figure 13. Low-Power Shutdown Logic Diagram

If only the driver is re-enabled (\overline{DE} transitions to high) the driver outputs are driven according to the D input after the enable times given by t_{PZH2} and t_{PZL2} in the driver switching characteristics. If the D input is open when the driver is enabled, the driver outputs default to A high and B low, in accordance with the driver failsafe feature.

If only the receiver is re-enabled (\overline{RE} transitions to low) the receiver output is driven according to the state of the bus inputs (A and B) after the enable times given by t_{PZH2} and t_{PZL2} in the receiver switching characteristics. If there is no valid state on the bus the receiver responds as described in the failsafe operation section.

If both the receiver and driver are re-enabled simultaneously, the receiver output is driven according to the state of the bus inputs (A and B) and the driver output is driven according to the D input. Note that the state of the active driver affects the inputs to the receiver. Therefore, the receiver outputs are valid as soon as the driver outputs are valid.

DEVICE INFORMATION (continued)
FUNCTION TABLES

**SN65HVD53, SN65HVD54, SN65HVD55, SN65HVD58,
SN65HVD59 DRIVER**

INPUTS		OUTPUTS	
D	DE	Y	Z
H	H	H	L
L	H	L	H
X	L or open	Z	Z
Open	H	L	H

**SN65HVD53, SN65HVD54, SN65HVD55, SN65HVD58,
SN65HVD59 RECEIVER**

DIFFERENTIAL INPUTS $V_{ID} = V_A - V_B$	ENABLE RE	OUTPUT R
$V_{ID} \leq -0.2 \text{ V}$	L	L
$-0.2 \text{ V} < V_{ID} < -0.02 \text{ V}$	L	?
$-0.02 \text{ V} \leq V_{ID}$	L	H
X	H or open	Z
Open Circuit	L	H
Idle circuit	L	H
Short Circuit, $V_A = V_B$	L	H

**SN65HVD50, SN65HVD51, SN65HVD52, SN65HVD56,
SN65HVD57 DRIVER**

INPUT D	OUTPUTS	
	Y	Z
H	H	L
L	L	H
Open	L	H

**SN65HVD50, SN65HVD51, SN65HVD52, SN65HVD56,
SN65HVD57 RECEIVER**

DIFFERENTIAL INPUTS $V_{ID} = V_A - V_B$	OUTPUT R
$V_{ID} \leq -0.2 \text{ V}$	L
$-0.2 \text{ V} < V_{ID} < -0.02 \text{ V}$?
$-0.02 \text{ V} \leq V_{ID}$	H
Open Circuit	H
Idle circuit	H
Short Circuit, $V_A = V_B$	H

EQUIVALENT INPUT AND OUTPUT SCHEMATIC DIAGRAMS

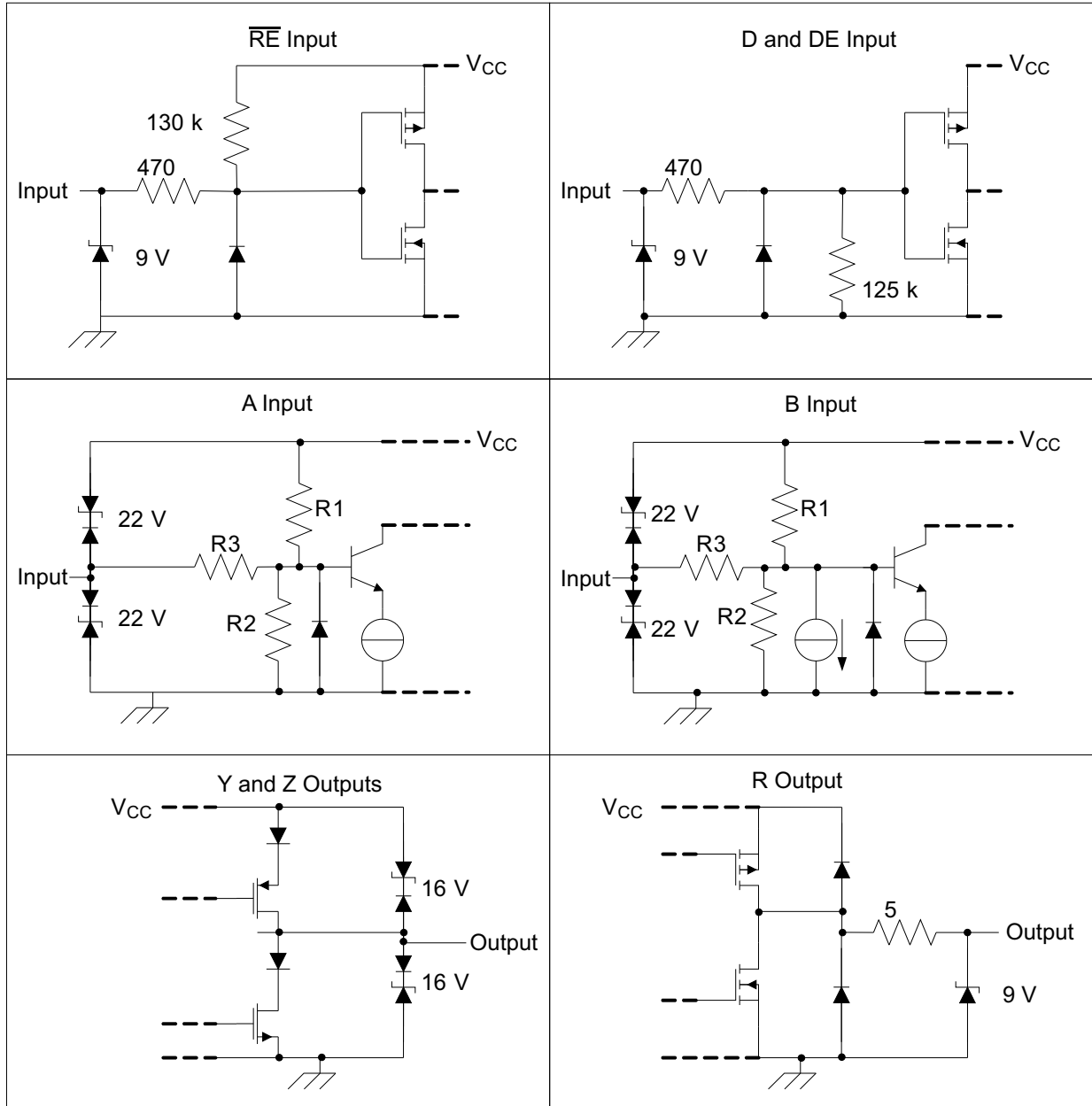

	R1/R2	R3
SN65HVD50, SN65HVD53, SN65HVD56, SN65HVD58	9 kΩ	45 kΩ
SN65HVD51, SN65HVD52, SN65HVD54, SN65HVD55, SN65HVD57, SN65HVD58, SN65HVD59	36 kΩ	180 kΩ

TYPICAL CHARACTERISTICS

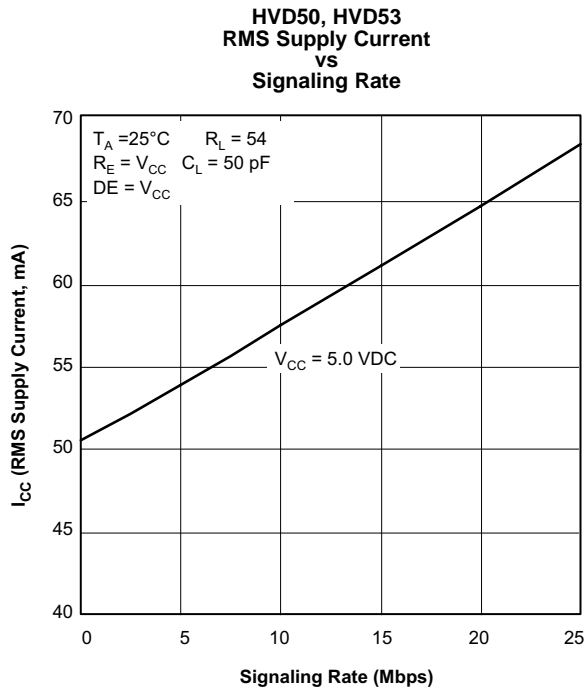

Figure 14.

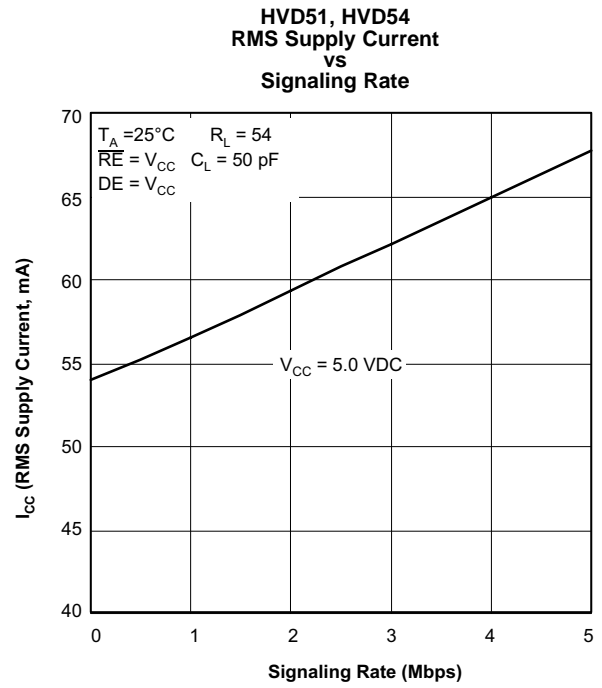

Figure 15.

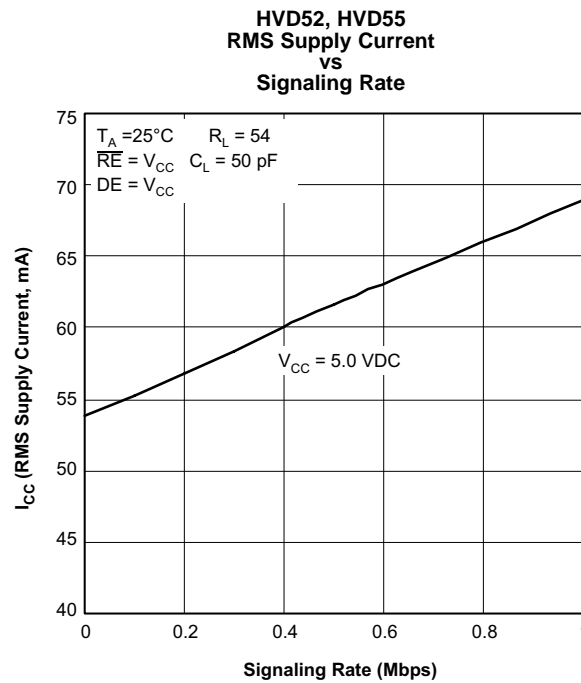

Figure 16.

TYPICAL CHARACTERISTICS (continued)

**HVD50, HVD53
Bus Input Current
vs
Input Voltage**

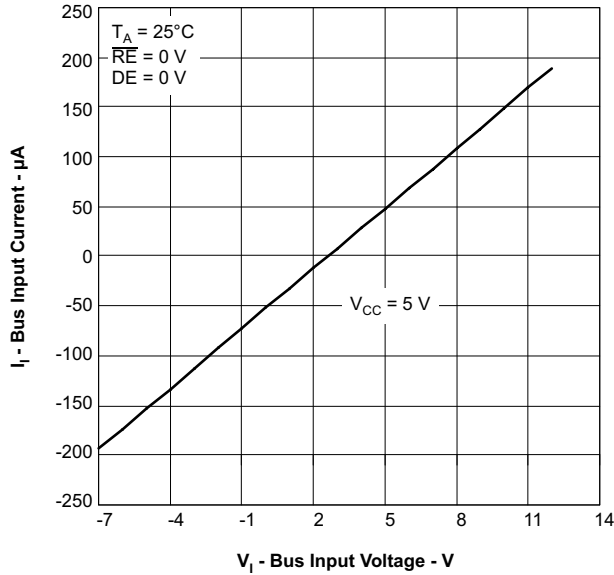

Figure 17.

**HVD51, HVD52, HVD54, HVD55
Bus Input Current
vs
Input Voltage**

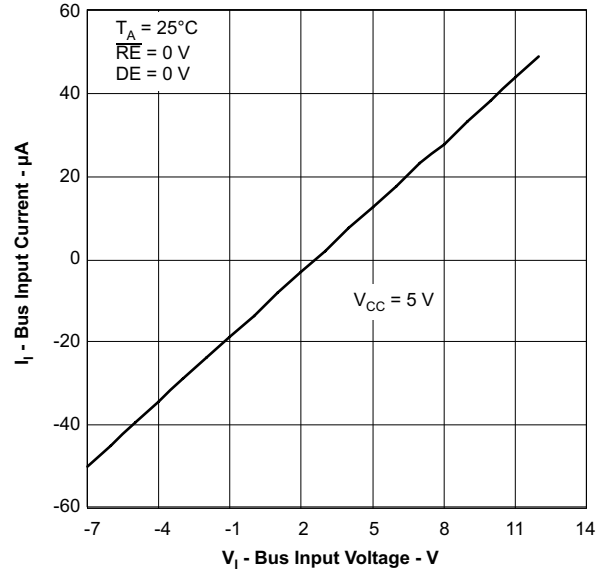

Figure 18.

**Driver Low-Level Output Current
vs
Low-Level Output Voltage**

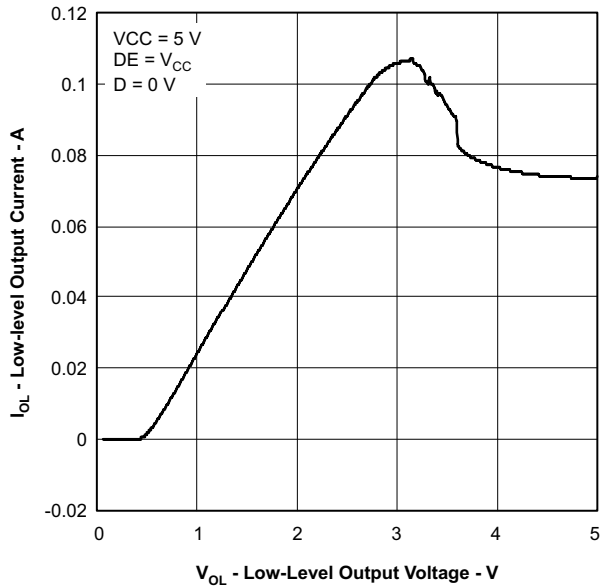

Figure 19.

**Driver High-Level Output Current
vs
High-Level Output Voltage**

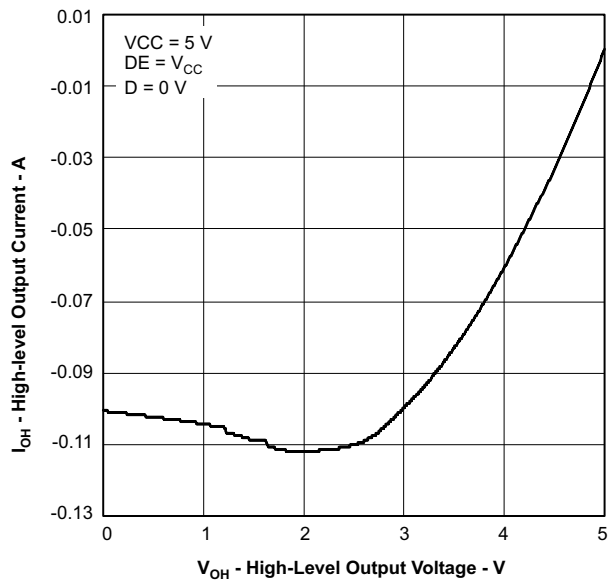

Figure 20.

TYPICAL CHARACTERISTICS (continued)

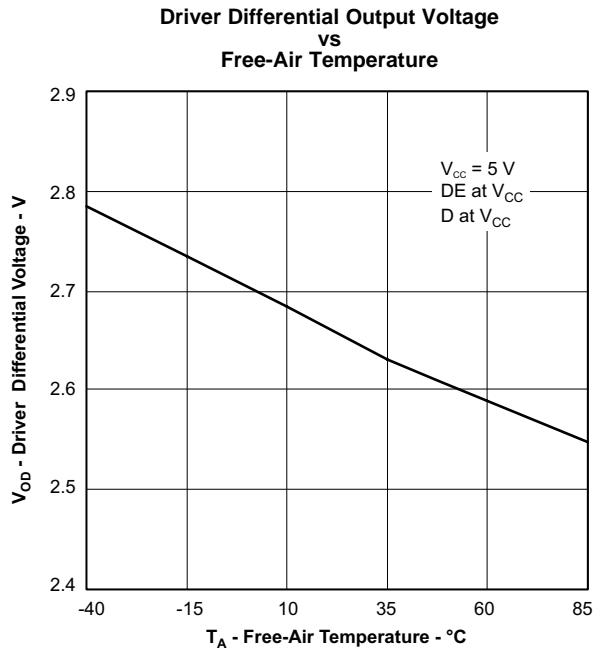

Figure 21.

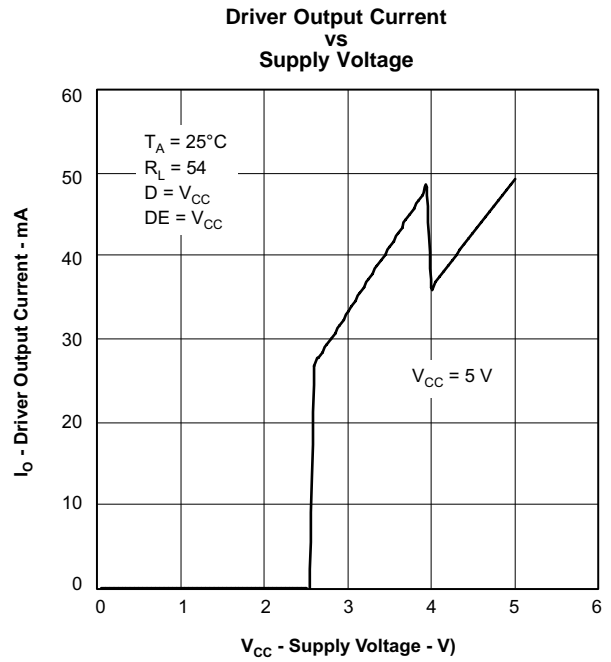

Figure 22.

APPLICATION INFORMATION

THERMAL CHARACTERISTICS OF IC PACKAGES

θ_{JA} (**Junction-to-Ambient Thermal Resistance**) is defined as the difference in junction temperature to ambient temperature divided by the operating power.

θ_{JA} is not a constant and is a strong function of:

- the PCB design (50% variation)
- altitude (20% variation)
- device power (5% variation)

θ_{JA} can be used to compare the thermal performance of packages if the specific test conditions are defined and used. Standardized testing includes specification of PCB construction, test chamber volume, sensor locations, and the thermal characteristics of holding fixtures. θ_{JA} is often misused when it is used to calculate junction temperatures for other installations.

TI uses two test PCBs as defined by JEDEC specifications. The low-k board gives *average* in-use condition thermal performance, and it consists of a single copper trace layer 25 mm long and 2-oz thick. The high-k board gives *best case* in-use condition, and it consists of two 1-oz buried power planes with a single copper trace layer 25 mm long and 2-oz thick. A 4% to 50% difference in θ_{JA} can be measured between these two test cards

θ_{JC} (**Junction-to-Case Thermal Resistance**) is defined as difference in junction temperature to case divided by the operating power. It is measured by putting the mounted package up against a copper block cold plate to force heat to flow from die, through the mold compound into the copper block.

θ_{JC} is a useful thermal characteristic when a heatsink applied to package. It is *not* a useful characteristic to predict junction temperature because it provides pessimistic numbers if the case temperature is measured in a nonstandard system and junction temperatures are backed out. It can be used with θ_{JB} in 1-dimensional thermal simulation of a package system.

θ_{JB} (**Junction-to-Board Thermal Resistance**) is defined as the difference in the junction temperature and the PCB temperature at the center of the package (closest to the die) when the PCB is clamped in a cold-plate structure. θ_{JB} is only defined for the high-k test card.

θ_{JB} provides an overall thermal resistance between the die and the PCB. It includes a bit of the PCB thermal resistance (especially for BGA's with thermal balls) and can be used for simple 1-dimensional network analysis of package system, see [Figure 23](#).

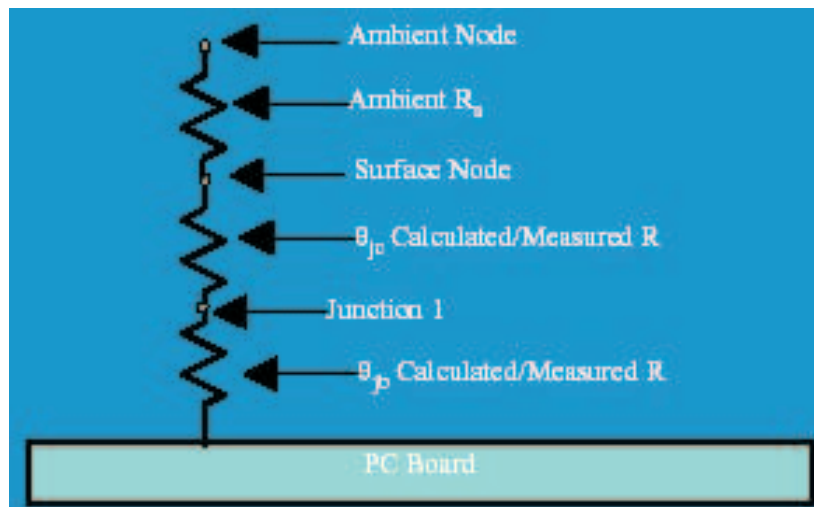

Figure 23. Thermal Resistance

PACKAGING INFORMATION

Orderable Device	Status ⁽¹⁾	Package Type	Package Drawing	Pins	Package Qty	Eco Plan ⁽²⁾	Lead/Ball Finish	MSL Peak Temp ⁽³⁾
SN65HVD53D	PREVIEW	SOIC	D	14	50	TBD	Call TI	Call TI
SN65HVD53DR	PREVIEW	SOIC	D	14	2500	TBD	Call TI	Call TI
SN65HVD54D	PREVIEW	SOIC	D	14	50	TBD	Call TI	Call TI
SN65HVD54DR	PREVIEW	SOIC	D	14	2500	TBD	Call TI	Call TI
SN65HVD55D	PREVIEW	SOIC	D	14	50	TBD	Call TI	Call TI
SN65HVD55DR	PREVIEW	SOIC	D	14	2500	TBD	Call TI	Call TI

⁽¹⁾ The marketing status values are defined as follows:

ACTIVE: Product device recommended for new designs.

LIFEBUY: TI has announced that the device will be discontinued, and a lifetime-buy period is in effect.

NRND: Not recommended for new designs. Device is in production to support existing customers, but TI does not recommend using this part in a new design.

PREVIEW: Device has been announced but is not in production. Samples may or may not be available.

OBSOLETE: TI has discontinued the production of the device.

⁽²⁾ Eco Plan - The planned eco-friendly classification: Pb-Free (RoHS) or Green (RoHS & no Sb/Br) - please check <http://www.ti.com/productcontent> for the latest availability information and additional product content details.

TBD: The Pb-Free/Green conversion plan has not been defined.

Pb-Free (RoHS): TI's terms "Lead-Free" or "Pb-Free" mean semiconductor products that are compatible with the current RoHS requirements for all 6 substances, including the requirement that lead not exceed 0.1% by weight in homogeneous materials. Where designed to be soldered at high temperatures, TI Pb-Free products are suitable for use in specified lead-free processes.

Green (RoHS & no Sb/Br): TI defines "Green" to mean Pb-Free (RoHS compatible), and free of Bromine (Br) and Antimony (Sb) based flame retardants (Br or Sb do not exceed 0.1% by weight in homogeneous material)

⁽³⁾ MSL, Peak Temp. -- The Moisture Sensitivity Level rating according to the JEDEC industry standard classifications, and peak solder temperature.

Important Information and Disclaimer:The information provided on this page represents TI's knowledge and belief as of the date that it is provided. TI bases its knowledge and belief on information provided by third parties, and makes no representation or warranty as to the accuracy of such information. Efforts are underway to better integrate information from third parties. TI has taken and continues to take reasonable steps to provide representative and accurate information but may not have conducted destructive testing or chemical analysis on incoming materials and chemicals. TI and TI suppliers consider certain information to be proprietary, and thus CAS numbers and other limited information may not be available for release.

In no event shall TI's liability arising out of such information exceed the total purchase price of the TI part(s) at issue in this document sold by TI to Customer on an annual basis.

PACKAGING INFORMATION

Orderable Device	Status ⁽¹⁾	Package Type	Package Drawing	Pins	Package Qty	Eco Plan ⁽²⁾	Lead/Ball Finish	MSL Peak Temp ⁽³⁾
SN65HVD53D	ACTIVE	SOIC	D	14	50	Green (RoHS & no Sb/Br)	CU NIPDAU	Level-1-260C-UNLIM
SN65HVD53DG4	ACTIVE	SOIC	D	14	50	Green (RoHS & no Sb/Br)	CU NIPDAU	Level-1-260C-UNLIM
SN65HVD53DR	ACTIVE	SOIC	D	14	2500	Green (RoHS & no Sb/Br)	CU NIPDAU	Level-1-260C-UNLIM
SN65HVD53DRG4	ACTIVE	SOIC	D	14	2500	Green (RoHS & no Sb/Br)	CU NIPDAU	Level-1-260C-UNLIM
SN65HVD54D	ACTIVE	SOIC	D	14	50	Green (RoHS & no Sb/Br)	CU NIPDAU	Level-1-260C-UNLIM
SN65HVD54DG4	ACTIVE	SOIC	D	14	50	Green (RoHS & no Sb/Br)	CU NIPDAU	Level-1-260C-UNLIM
SN65HVD54DR	ACTIVE	SOIC	D	14	2500	Green (RoHS & no Sb/Br)	CU NIPDAU	Level-1-260C-UNLIM
SN65HVD54DRG4	ACTIVE	SOIC	D	14	2500	Green (RoHS & no Sb/Br)	CU NIPDAU	Level-1-260C-UNLIM
SN65HVD55D	ACTIVE	SOIC	D	14	50	Green (RoHS & no Sb/Br)	CU NIPDAU	Level-1-260C-UNLIM
SN65HVD55DG4	ACTIVE	SOIC	D	14	50	Green (RoHS & no Sb/Br)	CU NIPDAU	Level-1-260C-UNLIM
SN65HVD55DR	ACTIVE	SOIC	D	14	2500	Green (RoHS & no Sb/Br)	CU NIPDAU	Level-1-260C-UNLIM
SN65HVD55DRG4	ACTIVE	SOIC	D	14	2500	Green (RoHS & no Sb/Br)	CU NIPDAU	Level-1-260C-UNLIM

⁽¹⁾ The marketing status values are defined as follows:

ACTIVE: Product device recommended for new designs.

LIFEBUY: TI has announced that the device will be discontinued, and a lifetime-buy period is in effect.

NRND: Not recommended for new designs. Device is in production to support existing customers, but TI does not recommend using this part in a new design.

PREVIEW: Device has been announced but is not in production. Samples may or may not be available.

OBSOLETE: TI has discontinued the production of the device.

⁽²⁾ Eco Plan - The planned eco-friendly classification: Pb-Free (RoHS) or Green (RoHS & no Sb/Br) - please check <http://www.ti.com/productcontent> for the latest availability information and additional product content details.

TBD: The Pb-Free/Green conversion plan has not been defined.

Pb-Free (RoHS): TI's terms "Lead-Free" or "Pb-Free" mean semiconductor products that are compatible with the current RoHS requirements for all 6 substances, including the requirement that lead not exceed 0.1% by weight in homogeneous materials. Where designed to be soldered at high temperatures, TI Pb-Free products are suitable for use in specified lead-free processes.

Green (RoHS & no Sb/Br): TI defines "Green" to mean Pb-Free (RoHS compatible), and free of Bromine (Br) and Antimony (Sb) based flame retardants (Br or Sb do not exceed 0.1% by weight in homogeneous material)

⁽³⁾ MSL, Peak Temp. -- The Moisture Sensitivity Level rating according to the JEDEC industry standard classifications, and peak solder temperature.

Important Information and Disclaimer:The information provided on this page represents TI's knowledge and belief as of the date that it is provided. TI bases its knowledge and belief on information provided by third parties, and makes no representation or warranty as to the accuracy of such information. Efforts are underway to better integrate information from third parties. TI has taken and continues to take reasonable steps to provide representative and accurate information but may not have conducted destructive testing or chemical analysis on incoming materials and chemicals. TI and TI suppliers consider certain information to be proprietary, and thus CAS numbers and other limited information may not be available for release.

In no event shall TI's liability arising out of such information exceed the total purchase price of the TI part(s) at issue in this document sold by TI to Customer on an annual basis.

D (R-PDSO-G14)

PLASTIC SMALL-OUTLINE PACKAGE



- NOTES:
- A. All linear dimensions are in inches (millimeters).
 - B. This drawing is subject to change without notice.
 - C. Body dimensions do not include mold flash or protrusion not to exceed 0.006 (0,15).
 - D. Falls within JEDEC MS-012 variation AB.

IMPORTANT NOTICE

Texas Instruments Incorporated and its subsidiaries (TI) reserve the right to make corrections, modifications, enhancements, improvements, and other changes to its products and services at any time and to discontinue any product or service without notice. Customers should obtain the latest relevant information before placing orders and should verify that such information is current and complete. All products are sold subject to TI's terms and conditions of sale supplied at the time of order acknowledgment.

TI warrants performance of its hardware products to the specifications applicable at the time of sale in accordance with TI's standard warranty. Testing and other quality control techniques are used to the extent TI deems necessary to support this warranty. Except where mandated by government requirements, testing of all parameters of each product is not necessarily performed.

TI assumes no liability for applications assistance or customer product design. Customers are responsible for their products and applications using TI components. To minimize the risks associated with customer products and applications, customers should provide adequate design and operating safeguards.

TI does not warrant or represent that any license, either express or implied, is granted under any TI patent right, copyright, mask work right, or other TI intellectual property right relating to any combination, machine, or process in which TI products or services are used. Information published by TI regarding third-party products or services does not constitute a license from TI to use such products or services or a warranty or endorsement thereof. Use of such information may require a license from a third party under the patents or other intellectual property of the third party, or a license from TI under the patents or other intellectual property of TI.

Reproduction of information in TI data books or data sheets is permissible only if reproduction is without alteration and is accompanied by all associated warranties, conditions, limitations, and notices. Reproduction of this information with alteration is an unfair and deceptive business practice. TI is not responsible or liable for such altered documentation.

Resale of TI products or services with statements different from or beyond the parameters stated by TI for that product or service voids all express and any implied warranties for the associated TI product or service and is an unfair and deceptive business practice. TI is not responsible or liable for any such statements.

Following are URLs where you can obtain information on other Texas Instruments products and application solutions:

Products		Applications	
Amplifiers	amplifier.ti.com	Audio	www.ti.com/audio
Data Converters	dataconverter.ti.com	Automotive	www.ti.com/automotive
DSP	dsp.ti.com	Broadband	www.ti.com/broadband
Interface	interface.ti.com	Digital Control	www.ti.com/digitalcontrol
Logic	logic.ti.com	Military	www.ti.com/military
Power Mgmt	power.ti.com	Optical Networking	www.ti.com/opticalnetwork
Microcontrollers	microcontroller.ti.com	Security	www.ti.com/security
		Telephony	www.ti.com/telephony
		Video & Imaging	www.ti.com/video
		Wireless	www.ti.com/wireless

Mailing Address: Texas Instruments
Post Office Box 655303 Dallas, Texas 75265