

### Features

- For AF input stages and driver applications
- High current gain
- Low collector-emitter saturation voltage
- Low noise between 30 Hz and 15 kHz
- Complementary types: BC 856, BC 857, BC 859, BC 860 (PNP)

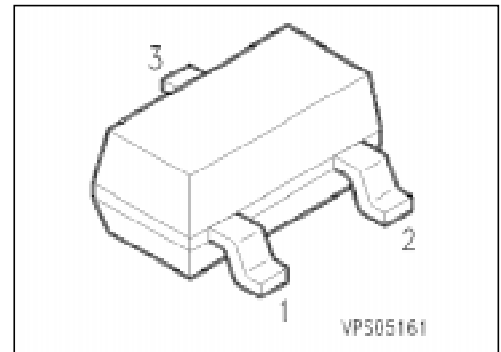

Type	Marking	Ordering Code (tape and reel)	Pin Configuration			Package <sup>1)</sup>
			1	2	3	
BC 846 A	1As	Q62702-C1772	B	E	C	SOT-23
BC 846 B	1Bs	Q62702-C1746				
BC 847 A	1Es	Q62702-C1884				
BC 847 B	1Fs	Q62702-C1687				
BC 847 C	1Gs	Q62702-C1715				
BC 848 A	1Js	Q62702-C1741				
BC 848 B	1Ks	Q62702-C1704				
BC 848 C	1Ls	Q62702-C1506				
BC 849 B	2Bs	Q62702-C1727				
BC 849 C	2Cs	Q62702-C1713				
BC 850 B	2Fs	Q62702-C1885				
BC 850 C	2Gs	Q62702-C1712				

<sup>1)</sup>For detailed information see chapter Package Outlines.

## Maximum Ratings

Parameter	Symbol	Values			Unit
		BC 846	BC 847 BC 850	BC 848 BC 849	
Collector-emitter voltage	$V_{CE0}$	65	45	30	V
Collector-base voltage	$V_{CB0}$	80	50	30	
Collector-emitter voltage	$V_{CES}$	80	50	30	
Emitter-base voltage	$V_{EB0}$	6	6	5	
Collector current	$I_C$	100			mA
Peak collector current	$I_{CM}$	200			
Peak base current	$I_{BM}$	200			
Peak emitter current	$I_{EM}$	200			
Total power dissipation, $T_s = 71\text{ °C}$	$P_{tot}$	330			mW
Junction temperature	$T_j$	150			°C
Storage temperature range	$T_{stg}$	- 65 ... + 150			

## Thermal Resistance

Junction - ambient <sup>1)</sup>	$R_{th\ JA}$	≤ 310	K/W
Junction - soldering point	$R_{th\ JS}$	≤ 240	

<sup>1)</sup>Package mounted on epoxy pcb 40 mm × 40 mm × 1.5 mm/6 cm<sup>2</sup> Cu.

## Electrical Characteristics

at  $T_A = 25\text{ °C}$ , unless otherwise specified.

Parameter	Symbol	Values			Unit
		min.	typ.	max.	

### DC characteristics

Collector-emitter breakdown voltage $I_C = 10\text{ mA}$ BC 846 BC 847, BC 850 BC 848, BC 849	$V_{(BR)CE0}$	65 45 30	— — —	— — —	V
Collector-base breakdown voltage $I_C = 10\text{ }\mu\text{A}$ BC 846 BC 847, BC 850 BC 848, BC 849	$V_{(BR)CB0}$	80 50 30	— — —	— — —	
Collector-emitter breakdown voltage $I_C = 10\text{ }\mu\text{A}$ , $V_{BE} = 0$ BC 846 BC 847, BC 850 BC 848, BC 849	$V_{(BR)CES}$	80 50 30	— — —	— — —	
Emitter-base breakdown voltage $I_E = 1\text{ }\mu\text{A}$ BC 846, BC 847 BC 848, BC 849, BC 850	$V_{(BR)EB0}$	6 5	— —	— —	
Collector cutoff current $V_{CB} = 30\text{ V}$ $V_{CB} = 30\text{ V}$ , $T_A = 150\text{ °C}$	$I_{CB0}$	— —	— —	15 5	nA $\mu\text{A}$
DC current gain $I_C = 10\text{ }\mu\text{A}$ , $V_{CE} = 5\text{ V}$ BC 846 A, BC 847 A, BC 848 A BC 846 B ... BC 850 B BC 847 C, BC 848 C, BC 849 C, BC 850 C $I_C = 2\text{ mA}$ , $V_{CE} = 5\text{ V}$ BC 846 A, BC 847 A, BC 848 A BC 846 B ... BC 850 B BC 847 C, BC 848 C, BC 849 C, BC 850 C	$h_{FE}$	— — — 110 200 420	140 250 480 180 290 520	— — — 220 450 800	—
Collector-emitter saturation voltage <sup>1)</sup> $I_C = 10\text{ mA}$ , $I_B = 0.5\text{ mA}$ $I_C = 100\text{ mA}$ , $I_B = 5\text{ mA}$	$V_{CEsat}$	— —	90 200	250 600	mV
Base-emitter saturation voltage <sup>1)</sup> $I_C = 10\text{ mA}$ , $I_B = 0.5\text{ mA}$ $I_C = 100\text{ mA}$ , $I_B = 5\text{ mA}$	$V_{BEsat}$	— —	700 900	— —	
Base-emitter voltage $I_C = 2\text{ mA}$ , $V_{CE} = 5\text{ V}$ $I_C = 10\text{ mA}$ , $V_{CE} = 5\text{ V}$	$V_{BE(on)}$	580 —	660 —	700 770	

<sup>1)</sup>Pulse test:  $t \leq 300\text{ }\mu\text{s}$ ,  $D = 2\text{ %}$ .

## Electrical Characteristics

at  $T_A = 25\text{ °C}$ , unless otherwise specified.

Parameter	Symbol	Values			Unit
		min.	typ.	max.	
<b>AC characteristics</b>					
Transition frequency $I_C = 20\text{ mA}$ , $V_{CE} = 5\text{ V}$ , $f = 100\text{ MHz}$	$f_T$	–	250	–	MHz
Output capacitance $V_{CB} = 10\text{ V}$ , $f = 1\text{ MHz}$	$C_{obo}$	–	3	–	pF
Input capacitance $V_{CB} = 0.5\text{ V}$ , $f = 1\text{ MHz}$	$C_{ibo}$	–	8	–	
Short-circuit input impedance $I_C = 2\text{ mA}$ , $V_{CE} = 5\text{ V}$ , $f = 1\text{ kHz}$	$h_{11e}$				k $\Omega$
BC 846 A ... BC 848 A	–	2.7	–		
BC 846 B ... BC 850 B	–	4.5	–		
BC 847 C ... BC 850 C	–	8.7	–		
Open-circuit reverse voltage transfer ratio $I_C = 2\text{ mA}$ , $V_{CE} = 5\text{ V}$ , $f = 1\text{ kHz}$	$h_{12e}$				$10^{-4}$
BC 846 A ... BC 848 A	–	1.5	–		
BC 846 B ... BC 850 B	–	2.0	–		
BC 847 C ... BC 850 C	–	3.0	–		
Short-circuit forward current transfer ratio $I_C = 2\text{ mA}$ , $V_{CE} = 5\text{ V}$ , $f = 1\text{ kHz}$	$h_{21e}$				–
BC 846 A ... BC 848 A	–	200	–		
BC 846 B ... BC 850 B	–	330	–		
BC 847 C ... BC 850 C	–	600	–		
Open-circuit output admittance $I_C = 2\text{ mA}$ , $V_{CE} = 5\text{ V}$ , $f = 1\text{ kHz}$	$h_{22e}$				$\mu\text{S}$
BC 846 A ... BC 848 A	–	18	–		
BC 846 B ... BC 850 B	–	30	–		
BC 847 C ... BC 850 C	–	60	–		
Noise figure $I_C = 0.2\text{ mA}$ , $V_{CE} = 5\text{ V}$ , $R_S = 2\text{ k}\Omega$	$F$				dB
$f = 30\text{ Hz} \dots 15\text{ kHz}$					
BC 849	–	1.4	4		
BC 850	–	1.4	3		
$f = 1\text{ kHz}$ , $\Delta f = 200\text{ Hz}$					
BC 849	–	1.2	4		
BC 850	–	1.0	4		
Equivalent noise voltage $I_C = 0.2\text{ mA}$ , $V_{CE} = 5\text{ V}$ , $R_S = 2\text{ k}\Omega$	$V_n$	–	–	0.135	$\mu\text{V}$
$f = 10\text{ Hz} \dots 50\text{ Hz}$					
BC 850					

### Total power dissipation $P_{tot} = f(T_A^*; T_S)$

\* Package mounted on epoxy

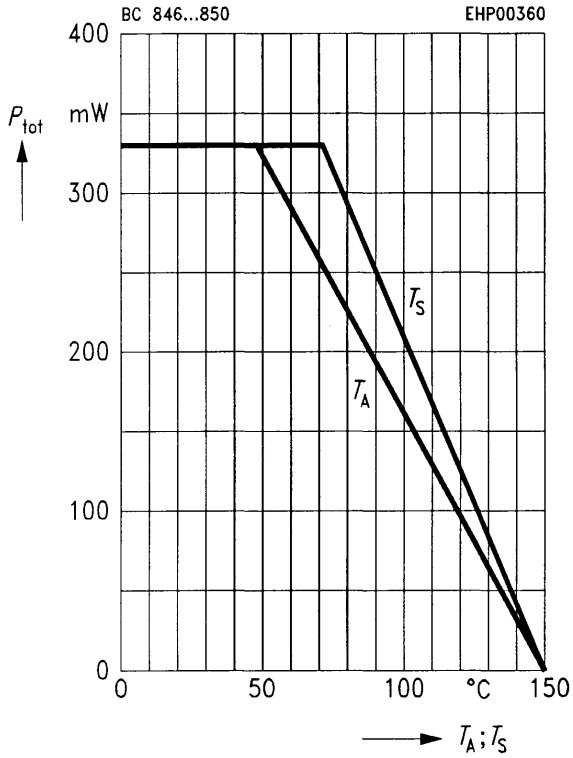

### Collector-base capacitance $C_{CB0} = f(V_{CB0})$

### Emitter-base capacitance $C_{EB0} = f(V_{EB0})$

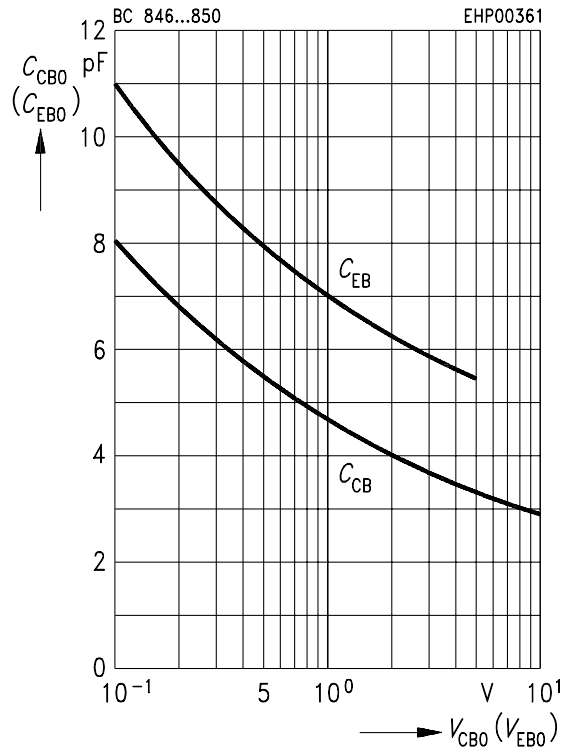

### Permissible pulse load $P_{tot max}/P_{tot DC} = f(t_p)$

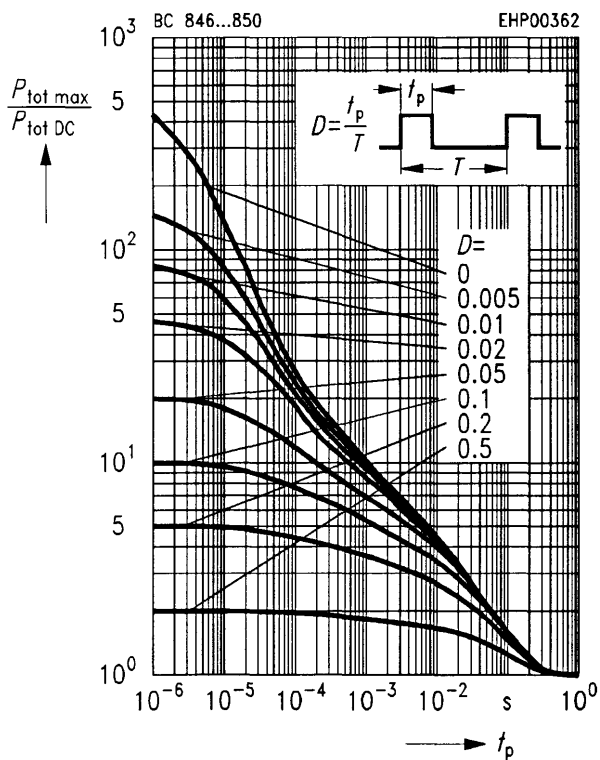

### Transition frequency $f_T = f(I_C)$

$V_{CE} = 5 V$

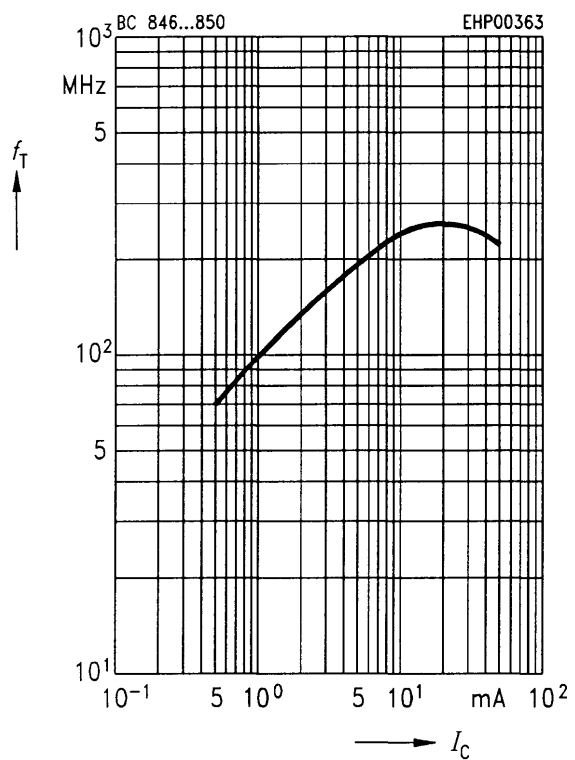

**Collector cutoff current  $I_{CB0} = f(T_A)$**

$V_{CB} = 30\text{ V}$

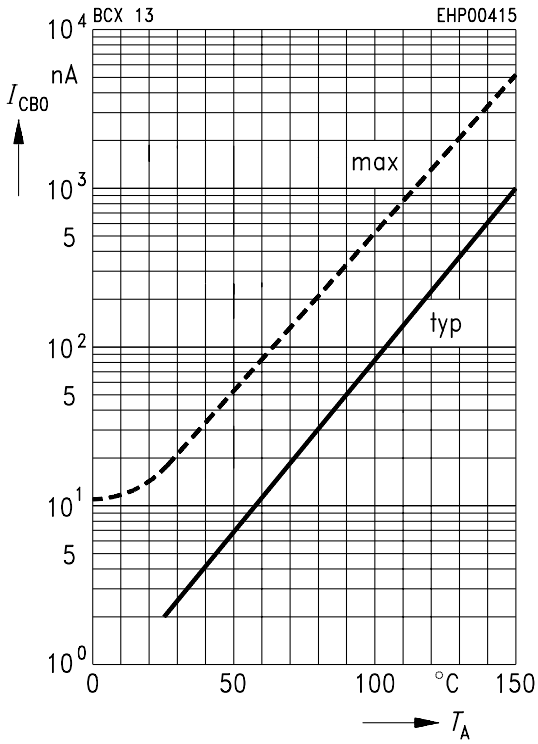

**Collector-emitter saturation voltage  $I_C = f(V_{CEsat}, h_{FE} = 20)$**

$I_C = f(V_{CEsat}, h_{FE} = 20)$

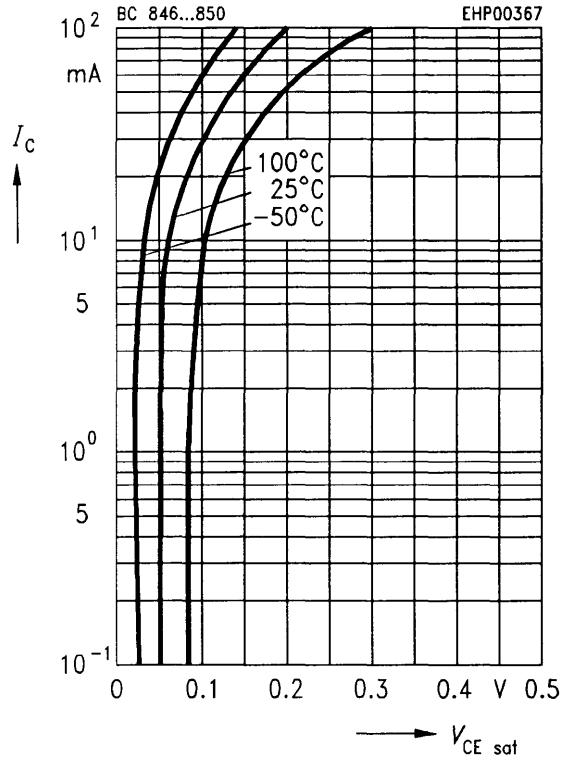

**DC current gain  $h_{FE} = f(I_C)$**

$V_{CE} = 5\text{ V}$

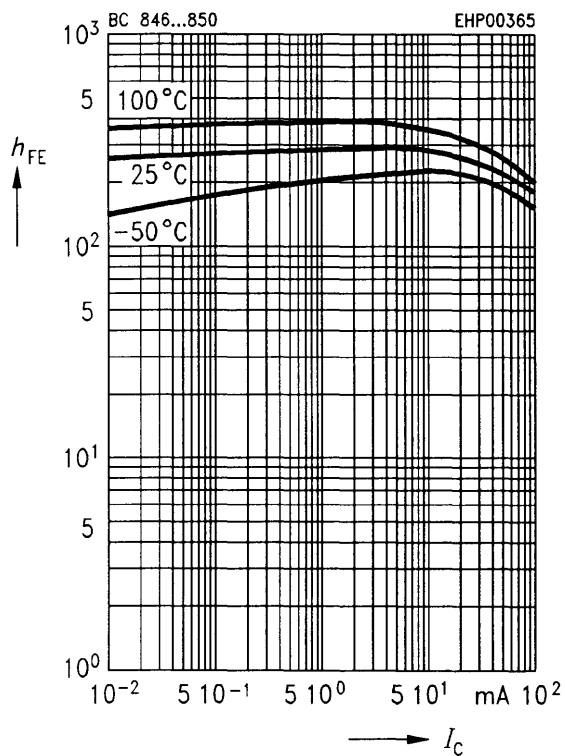

**Base-emitter saturation voltage  $I_C = f(V_{BEsat}, h_{FE} = 20)$**

$I_C = f(V_{BEsat}, h_{FE} = 20)$

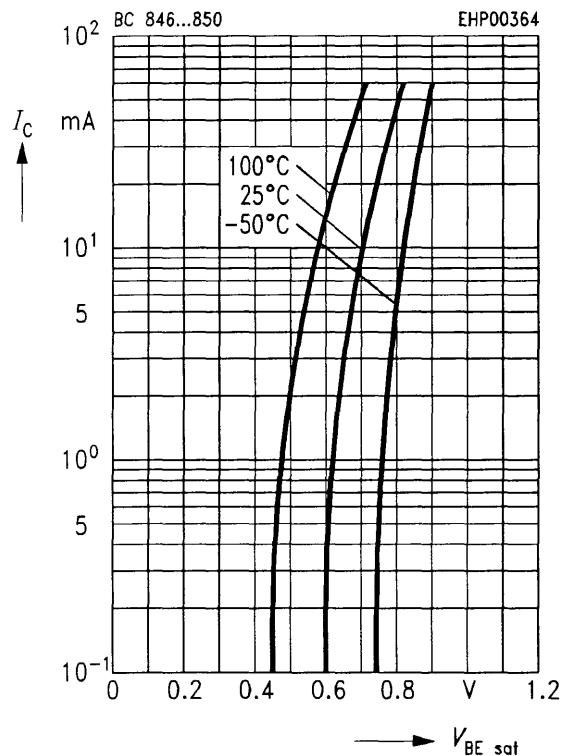

**h parameter  $h_e = f(I_C)$  normalized**

$V_{CE} = 5\text{ V}$

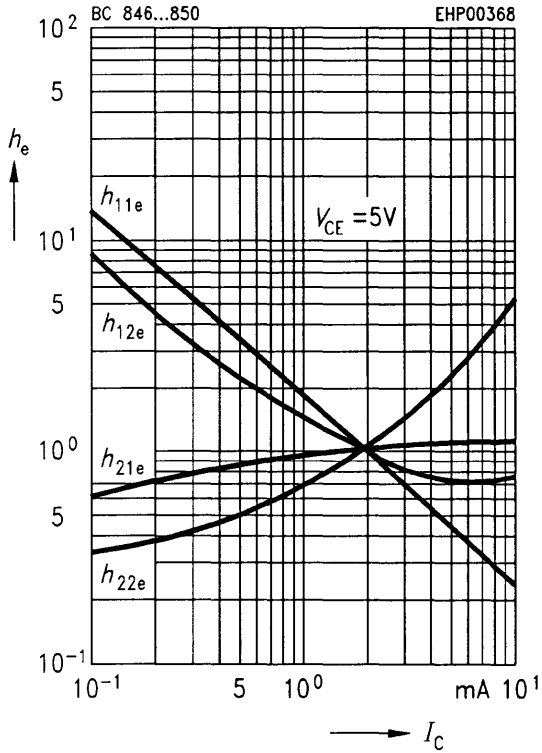

**h parameter  $h_e = f(V_{CE})$  normalized**

$I_C = 2\text{ mA}$

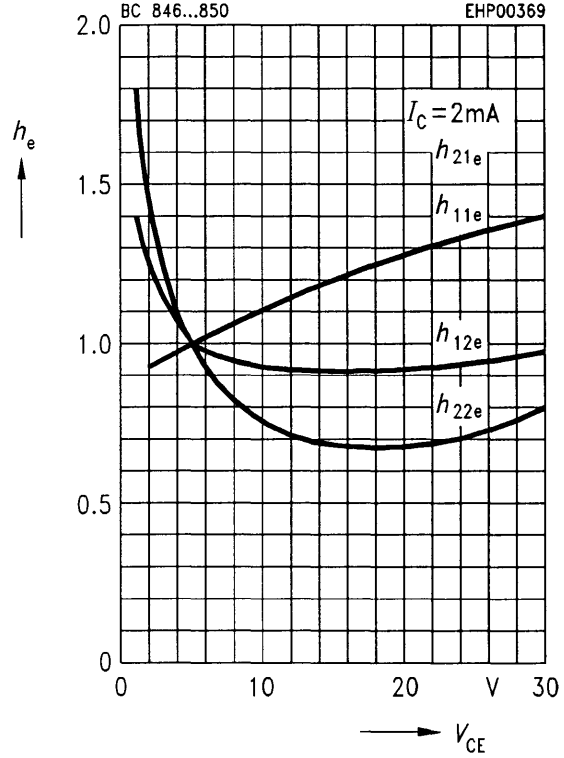

**Noise figure  $F = f(V_{CE})$**

$I_C = 0.2\text{ mA}$ ,  $R_S = 2\text{ k}\Omega$ ,  $f = 1\text{ kHz}$

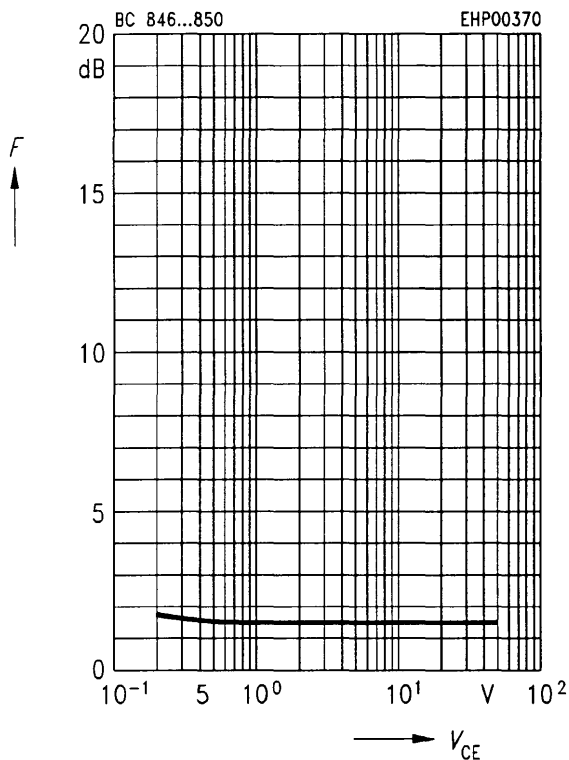

**Noise figure  $F = f(f)$**

$I_C = 0.2\text{ mA}$ ,  $V_{CE} = 5\text{ V}$ ,  $R_S = 2\text{ k}\Omega$

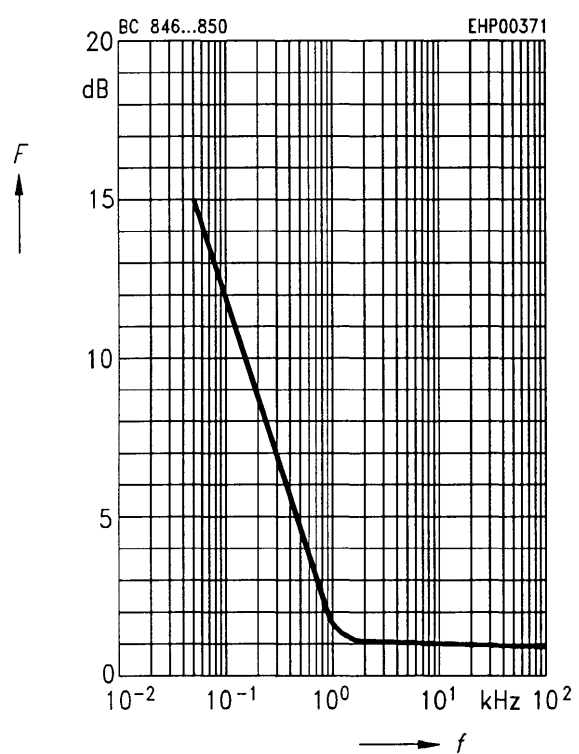

**Noise figure  $F = f(I_C)$**

$V_{CE} = 5 \text{ V}, f = 120 \text{ Hz}$

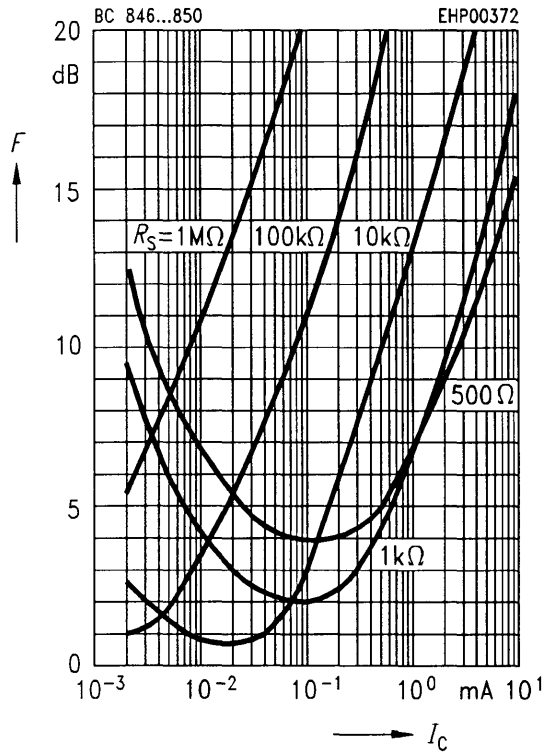

**Noise figure  $F = f(I_C)$**

$V_{CE} = 5 \text{ V}, f = 1 \text{ kHz}$

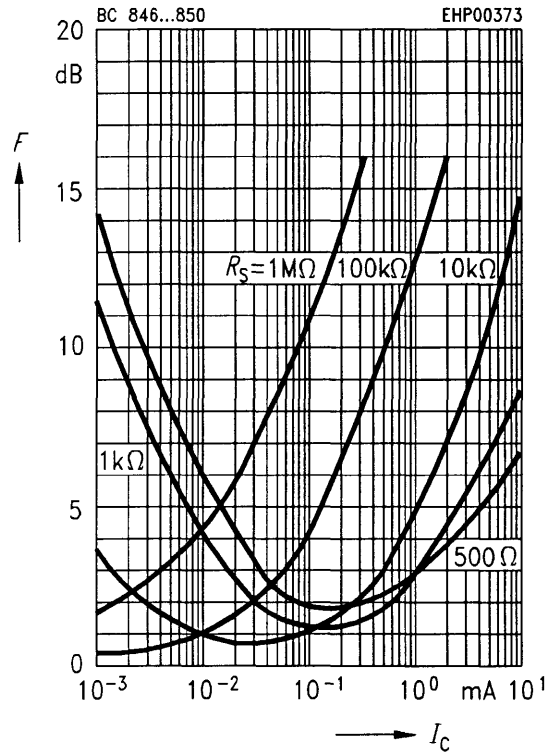

**Noise figure  $F = f(I_C)$**

$V_{CE} = 5 \text{ V}, f = 10 \text{ kHz}$

