

SMBJ5.0(C)A - SMBJ170(C)A

Features

- Glass passivated junction.
- 600W Peak Pulse Power capability on 10/1000 μ s waveform.
- Excellent clamping capability.
- Low incremental surge resistance.
- Fast response time; typically less than 1.0 ps from 0 volts to BV for unidirectional and 5.0 ns for bidirectional.
- Typical I_R less than 1.0 μ A above 10V.

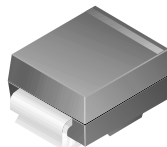

SMB/DO-214AA
COLOR BAND DENOTES CATHODE ON UNIDIRECTIONAL DEVICES ONLY. NO COLOR BAND ON BIDIRECTIONAL DEVICES.

DEVICES FOR BIPOLAR APPLICATIONS

- Bidirectional types use CA suffix.
- Electrical Characteristics apply in both directions.

600 Watt Transient Voltage Suppressors

Absolute Maximum Ratings* $T_A = 25^\circ\text{C}$ unless otherwise noted

Symbol	Parameter	Value	Units
P_{PPM}	Peak Pulse Power Dissipation on 10/1000 μ s waveform	minimum 600	W
I_{PPM}	Peak Pulse Current on 10/1000 μ s waveform	see table	A
I_{FSM}	Non-repetitive Peak Forward Surge Current superimposed on rated load (JEDEC method) (Note 1)	100	A
T_{stg}	Storage Temperature Range	-55 to +150	$^\circ\text{C}$
T_J	Operating Junction Temperature	-55 to +150	$^\circ\text{C}$

*These ratings are limiting values above which the serviceability of any semiconductor device may be impaired.

Note 1: Measured on 8.3 ms single half-sine wave or equivalent square wave; Duty cycle = 4 pulses per minute maximum.

Transient Voltage Suppressors

(continued)

Electrical Characteristics

T_A = 25°C unless otherwise noted

Uni-directional Bi-directional (C) Device	Part Marking*	Reverse Stand-off Voltage V _{RWM} (V)	Breakdown Voltage V _{BR} (V)		Test Current I _T (mA)	Max Clamping Voltage @1PPM V _C (V)	Max Peak Pulse Surge Current I _{PPM} (A)	Max Reverse Leakage V _{RWM} I _R (uA)**
			min	max				
SMBJ5.0(C)A	KE	5.0	6.40	7.0	10	9.2	65.2	800
SMBJ6.0(C)A	KG	6.0	6.67	7.37	10	10.3	58.3	800
SMBJ6.5(C)A	KK(AK)	6.5	7.22	7.98	10	11.2	53.6	500
SMBJ7.0(C)A	KM	7.0	7.78	8.60	10	12.0	50.0	200
SMBJ7.5(C)A	KP(AP)	7.5	8.33	9.21	1	12.9	46.5	100
SMBJ8.0(C)A	KR(AR)	8.0	8.89	9.83	1	13.6	44.1	50
SMBJ8.5(C)A	KT(AT)	8.5	9.44	10.4	1	14.4	41.7	20
SMBJ9.0(C)A	KV(AV)	9.0	10.0	11.1	1	15.4	39.0	10
SMBJ10(C)A	KX(AX)	10	11.1	12.8	1	17.0	35.3	5
SMBJ11(C)A	KZ	11	12.2	13.5	1	18.2	33.0	5
SMBJ12(C)A	LE(BE)	12	13.3	14.7	1	19.9	30.2	5
SMBJ13(C)A	LG	13	14.4	15.9	1	21.5	27.9	5
SMBJ14(C)A	LK(BK)	14	15.6	17.2	1	23.2	25.9	5
SMBJ15(C)A	LV(BM)	15	16.7	18.5	1	24.4	24.6	5
SMBJ16(C)A	LP(LM)	16	17.8	19.7	1	26.0	23.1	5
SMBJ17(C)A	LR	17	18.9	20.9	1	27.6	21.7	5
SMBJ18(C)A	LT(BT)	18	20.0	22.1	1	29.2	20.5	5
SMBJ20(C)A	LV	20	22.2	24.5	1	32.4	18.5	5
SMBJ22(C)A	LX(BX)	22	24.4	26.9	1	35.5	16.9	5
SMBJ24(C)A	LZ(BZ)	24	26.7	29.5	1	38.9	15.4	5
SMBJ26(C)A	ME(CE)	26	28.9	31.9	1	42.1	14.3	5
SMBJ28(C)A	MG	28	31.1	34.4	1	45.4	13.2	5
SMBJ30(C)A	MK(CK)	30	33.3	36.8	1	48.4	12.4	5
SMBJ33(C)A	MM(CM)	33	36.7	40.6	1	53.3	11.3	5
SMBJ36(C)A	MP(CP)	36	40.0	44.2	1	58.1	10.3	5
SMBJ40(C)A	MR(CR)	40	44.4	49.1	1	64.5	9.3	5
SMBJ43(C)A	MT(CT)	43	47.8	52.8	1	69.4	8.6	5
SMBJ45(C)A	MV	45	50.0	55.3	1	72.7	8.3	5
SMBJ48(C)A	MX	48	53.3	58.9	1	77.4	7.8	5
SMBJ51(C)A	MZ	51	56.7	62.7	1	82.4	7.3	5
SMBJ54(C)A	NE	54	60.0	66.3	1	87.1	6.9	5
SMBJ58(C)A	NG	58	64.4	71.2	1	93.6	6.4	5
SMBJ60(C)A	NK	60	66.7	73.7	1	96.8	6.2	5
SMBJ64(C)A	NM	64	71.1	78.6	1	103.0	5.8	5
SMBJ70(C)A	NP	70	77.8	86.0	1	113.0	5.3	5
SMBJ75(C)A	NR	75	83.3	92.1	1	121.0	5.0	5
SMBJ78(C)A	NT	78	86.7	95.8	1	126.0	4.8	5
SMBJ85(C)A	NV	85	94.4	104.0	1	137.0	4.4	5
SMBJ90(C)A	NX	90	100.0	111.0	1	146.0	4.1	5
SMBJ100(C)A	NZ	100	111.0	123.0	1	162.0	3.7	5
SMBJ110(C)A	PE	110	122.0	135.0	1	177.0	3.4	5
SMBJ120(C)A	PG	120	133.0	147.0	1	193.0	3.1	5
SMBJ130(C)A	PK	130	144.0	159.0	1	209.0	2.9	5
SMBJ150(C)A	PM	150	167.0	185.0	1	243.0	2.5	5
SMBJ160(C)A	PP	160	178.0	197.0	1	259.0	2.3	5
SMBJ170(C)A	PR	170	189.0	209.0	1	275.0	2.2	5

* Color band denotes cathode on unidirectional devices only. No color band on bidirectional devices.

** For bidirectional parts with V_{RWM} < 10V, the I_R max limit is doubled.

SMBJ5.0(C)A - SMBJ170(C)A

Typical Characteristics

Peak Pulse Power Rating Curve

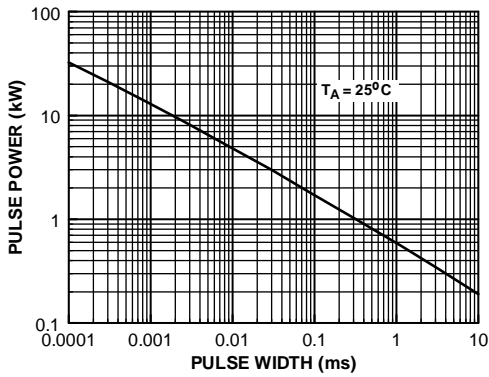

Pulse Derating Curve

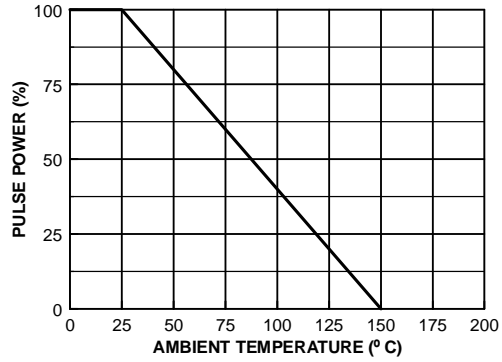

Pulse Waveform

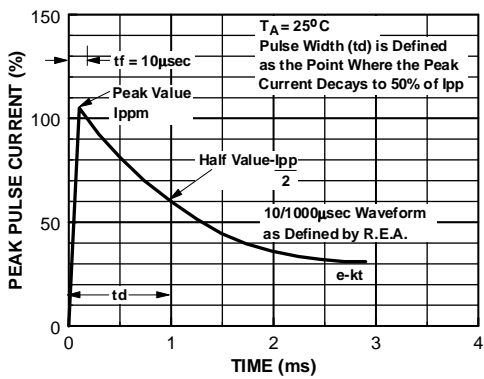

Junction Capacitance

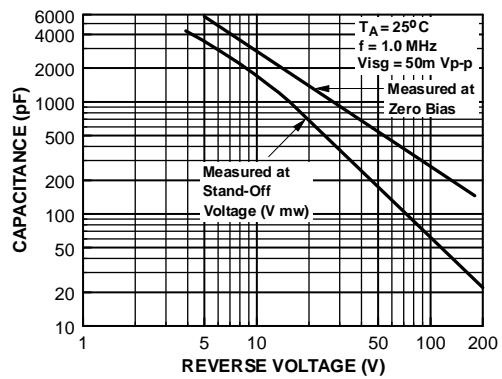

Non-Repetitive Surge Current

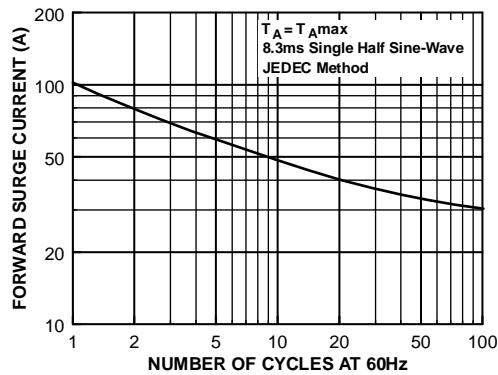

DO-214AA(SMB) Tape and Reel Data



DO-214AA(SMB) Packaging Configuration: Figure 1.0

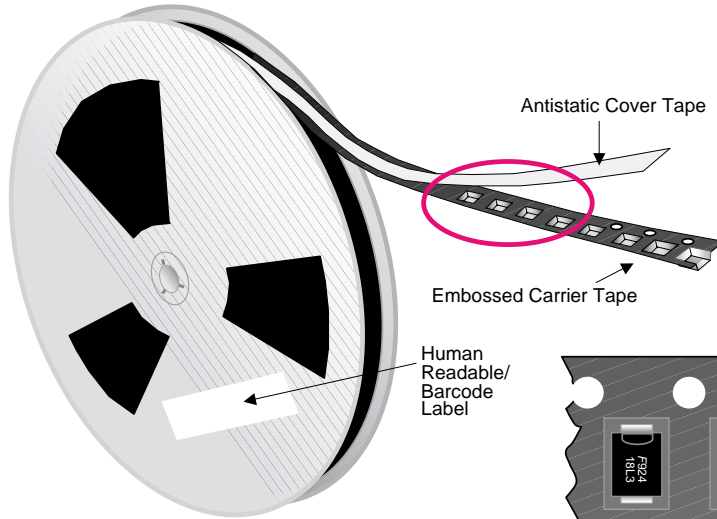

Packaging Description:

DO-214AA(SMB) parts are shipped in tape. The carrier tape is made from a dissipative (carbon filled) polycarbonate resin. Alternate carrier tape is made of anti-static plastic. The cover tape is a multilayer film (Heat Activated Adhesive in nature) primarily composed of polyester film, adhesive layer, sealant, and anti-static sprayed agent. These reeled parts in standard option are shipped with 7,500 units per 13" or 330cm diameter reel. The reel comes in plastic or carton which is made of polystyrene plastic (anti-static coated) and thick white paper respectively. Further information is described in the Packaging Information table.

These full reels are individually labeled and placed inside a bleach box (illustrated in figure 1.0) made of recyclable carton paper with a Fairchild logo printing. One box contains two reels maximum. Certain number of these boxes are placed inside shipping box which comes in different sizes depending on the number of parts shipped.

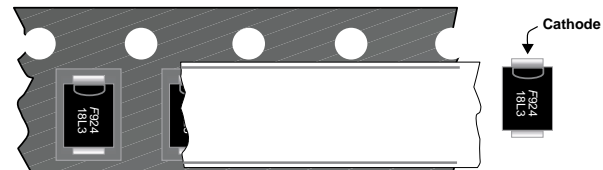

DO-214AA(SMB) unit orientation

DO-214AA(SMB) Packaging Information		
Packaging Option	Under package code P5	Under package code MA
Packaging type	TNR	TNR
Qty per Reel/Tube/Bag	3,000	3,000
Reel Size (inch diameter)	13	13
Box Dimension (mm)	336x336x38	336X336X38
Max qty per Box	6,000	6,000
Weight per unit (gm)	0.093	0.093
Weight per Reel (kg)	0.705	0.705
Note/Comments	Human readable label	Barcode label

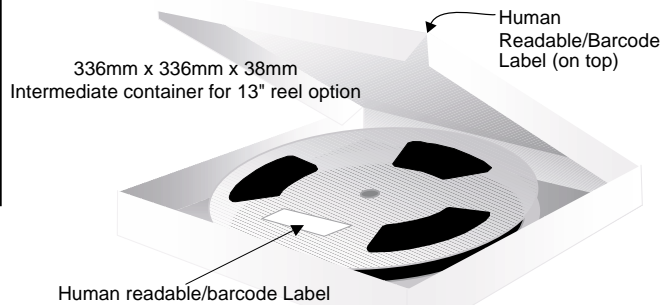

Human readable/barcode Label

Human Readable Label sample



F63TNR Label sample



DO-214AA(SMB) Tape Leader and Trailer Configuration: Figure 2.0

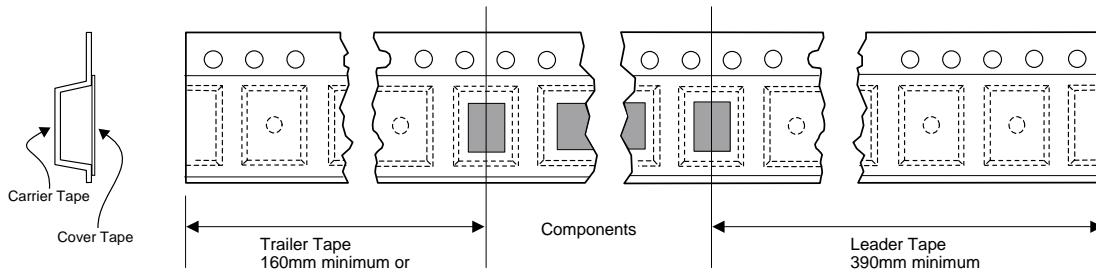

DO-214AA(SMB) Tape and Reel Data, continued

DO-214AA(SMB) Embossed Carrier Tape Configuration: Figure 3.0

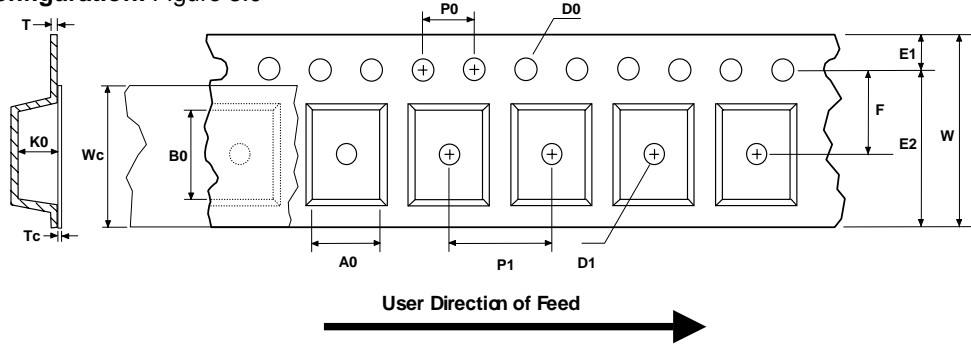

Dimensions are in millimeter

Pkg type	A0	B0	W	D0	D1	E1	E2	F	P1	P0	K0	T	Wc	Tc
DO-214AA(SMB) (12mm)	3.79 +/-0.15	5.72 +/-0.15	12.0 +/-0.3	1.55 +/-0.05	1.125 +/-0.125	1.75 +/-0.10	10.25 min	5.5 +/-0.05	8.0 +/-0.1	4.0 +/-0.1	2.46 +/-0.30	0.25 +/-0.10	9.3 +/-0.025	0.06 +/-0.02

Notes: A0, B0, and K0 dimensions are determined with respect to the EIA/Jedec RS-481 rotational and lateral movement requirements (see sketches A, B, and C).

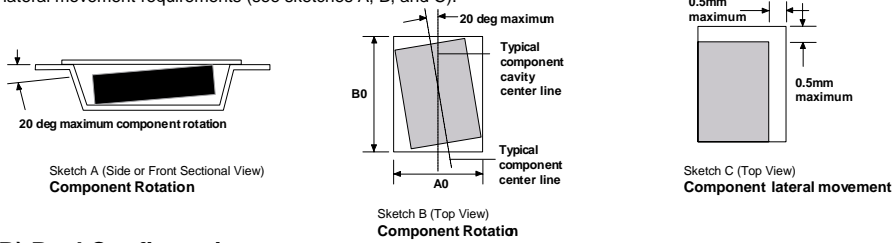

DO-214AA(SMB) Reel Configuration: Figure 4.0

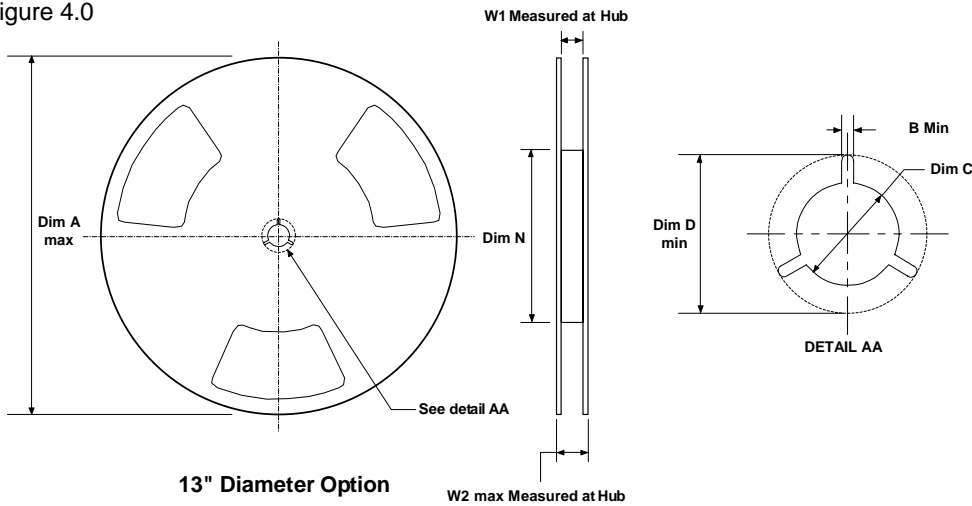

Dimensions are in inches and millimeters

Tape Size	Reel Option	Dim A	Dim B	Dim C	Dim D	Dim N	Dim W1	Dim W2
12mm	13" Dia	13.0 330	0.059 1.5	512 +0.020/-0.008 13 +0.5/-0.2	0.795 20.2	1.97 50 min	0.488 +0.078/-0.000 12.4 +2/-0	0.567 14.4

DO-214AA(SMB) Package Dimensions



DO-214AA(SMB) (FS PKG Code P6)

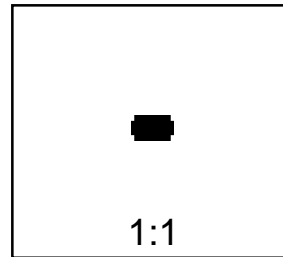
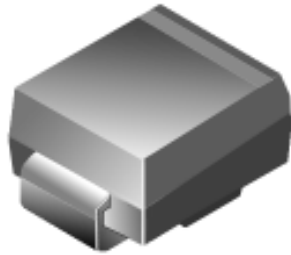

Scale 1:1 on letter size paper

Dimensions shown below are in:
inches [millimeters]

Part Weight per unit (gram): 0.093

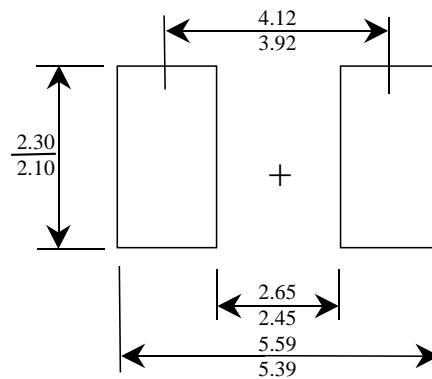
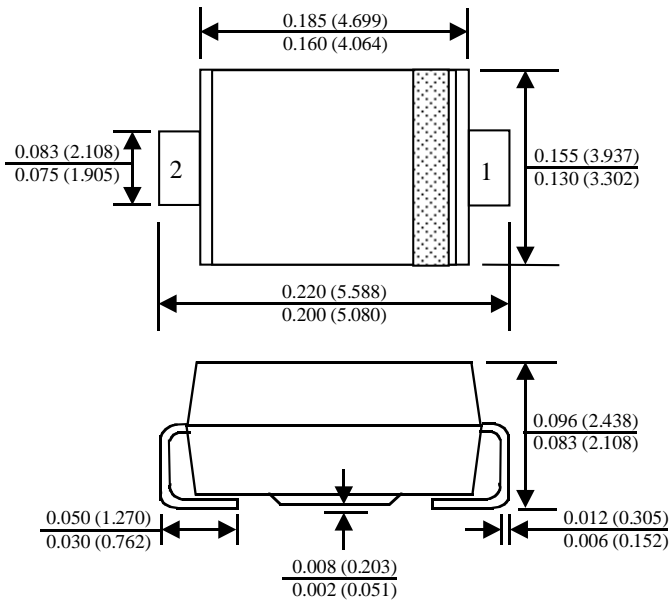

Minimum Recommended
Land Pattern

TRADEMARKS

The following are registered and unregistered trademarks Fairchild Semiconductor owns or is authorized to use and is not intended to be an exhaustive list of all such trademarks.

ACE _x TM	FAST [®]	PACMAN TM	SuperSOT TM -3
Bottomless TM	FAST _r TM	POP TM	SuperSOT TM -6
CoolFET TM	GlobalOptoisolator TM	PowerTrench [®]	SuperSOT TM -8
CROSSVOLT TM	GTO TM	QFET TM	SyncFET TM
DenseTrench TM	HiSeC TM	QS TM	TinyLogic TM
DOMET TM	ISOPLANAR TM	QT Optoelectronics TM	UHC TM
EcoSPARK TM	LittleFET TM	Quiet Series TM	UltraFET [®]
E ² CMOS TM	MicroFET TM	SILENT SWITCHER [®]	VCX TM
EnSigna TM	MICROWIRE TM	SMART START TM	
FACT TM	OPTOLOGIC TM	Star* Power TM	
FACT Quiet Series TM	OPTOPLANAR TM	Stealth TM	

DISCLAIMER

FAIRCHILD SEMICONDUCTOR RESERVES THE RIGHT TO MAKE CHANGES WITHOUT FURTHER NOTICE TO ANY PRODUCTS HEREIN TO IMPROVE RELIABILITY, FUNCTION OR DESIGN. FAIRCHILD DOES NOT ASSUME ANY LIABILITY ARISING OUT OF THE APPLICATION OR USE OF ANY PRODUCT OR CIRCUIT DESCRIBED HEREIN; NEITHER DOES IT CONVEY ANY LICENSE UNDER ITS PATENT RIGHTS, NOR THE RIGHTS OF OTHERS.

LIFE SUPPORT POLICY

FAIRCHILD'S PRODUCTS ARE NOT AUTHORIZED FOR USE AS CRITICAL COMPONENTS IN LIFE SUPPORT DEVICES OR SYSTEMS WITHOUT THE EXPRESS WRITTEN APPROVAL OF FAIRCHILD SEMICONDUCTOR CORPORATION. As used herein:

1. Life support devices or systems are devices or systems which, (a) are intended for surgical implant into the body, or (b) support or sustain life, or (c) whose failure to perform when properly used in accordance with instructions for use provided in the labeling, can be reasonably expected to result in significant injury to the user.
2. A critical component is any component of a life support device or system whose failure to perform can be reasonably expected to cause the failure of the life support device or system, or to affect its safety or effectiveness.

PRODUCT STATUS DEFINITIONS

Definition of Terms

Datasheet Identification	Product Status	Definition
Advance Information	Formative or In Design	This datasheet contains the design specifications for product development. Specifications may change in any manner without notice.
Preliminary	First Production	This datasheet contains preliminary data, and supplementary data will be published at a later date. Fairchild Semiconductor reserves the right to make changes at any time without notice in order to improve design.
No Identification Needed	Full Production	This datasheet contains final specifications. Fairchild Semiconductor reserves the right to make changes at any time without notice in order to improve design.
Obsolete	Not In Production	This datasheet contains specifications on a product that has been discontinued by Fairchild semiconductor. The datasheet is printed for reference information only.