



DC COMPONENTS CO., LTD.

RECTIFIER SPECIALISTS

**DB101
THRU
DB107**

TECHNICAL SPECIFICATIONS OF SINGLE-PHASE SILICON BRIDGE RECTIFIER

VOLTAGE RANGE - 50 to 1000 Volts

CURRENT - 1.0 Ampere

FEATURES

- * Good for automation insertion
- * Surge overload rating - 50 Amperes peak
- * Ideal for printed circuit board
- * Reliable low cost construction
- * Glass passivated junction

MECHANICAL DATA

- * Case: Molded plastic
- * Epoxy: UL 94V-0 rate flame retardant
- * Lead: MIL-STD-202E, Method 208 guaranteed
- * Polarity: Symbols molded or marked on body
- * Mounting position: Any
- * Weight: 0.4 gram

MAXIMUM RATINGS AND ELECTRICAL CHARACTERISTICS

Ratings at 25°C ambient temperature unless otherwise specified.
Single phase, half wave, 60 Hz, resistive or inductive load.
For capacitive load, derate current by 20%.

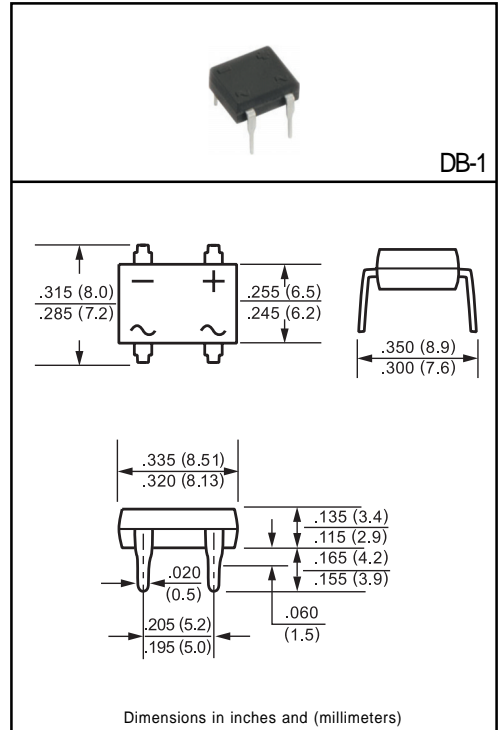

	SYMBOL	DB101	DB102	DB103	DB104	DB105	DB106	DB107	UNITS
Maximum Recurrent Peak Reverse Voltage	VRRM	50	100	200	400	600	800	1000	Volts
Maximum RMS Bridge Input Voltage	VRMS	35	70	140	280	420	560	700	Volts
Maximum DC Blocking Voltage	Vdc	50	100	200	400	600	800	1000	Volts
Maximum Average Forward Output Current at TA = 40°C	Io	1.0							Amps
Peak Forward Surge Current 8.3 ms single half sine-wave superimposed on rated load (JEDEC Method)	IFSM	50							Amps
Maximum Forward Voltage Drop per element at 1.0A DC	VF	1.1							Volts
Maximum DC Reverse Current at Rated DC Blocking Voltage per element	@TA = 25°C	10							uAmps
	@TA = 125°C	500							
I ² t Rating for Fusing (t<8.3ms)	I ² t	10							A ² Sec
Typical Junction Capacitance (Note1)	Cj	25							pF
Typical Thermal Resistance (Note 2)	RθJA	40							°C/W
Operating and Storage Temperature Range	TJ,TSTG	-65 to + 150							°C

NOTES : 1. Measured at 1 MHz and applied reverse voltage of 4.0 volts

2. Thermal Resistance from Junction to Ambient and from junction to lead mounted on P.C.B. with 0.5 x 0.5" (13x13mm) copper pads.

RATING AND CHARACTERISTIC CURVES (DB101 THRU DB107)

FIG. 1 - MAXIMUM NON-REPETITIVE FORWARD SURGE CURRENT

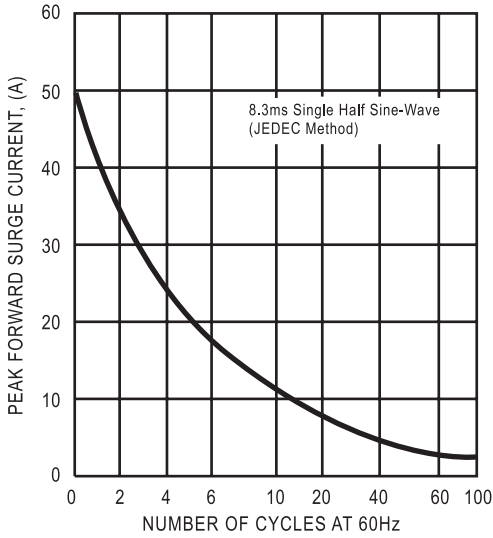

FIG. 2 - TYPICAL FORWARD CURRENT DERATING CURVE

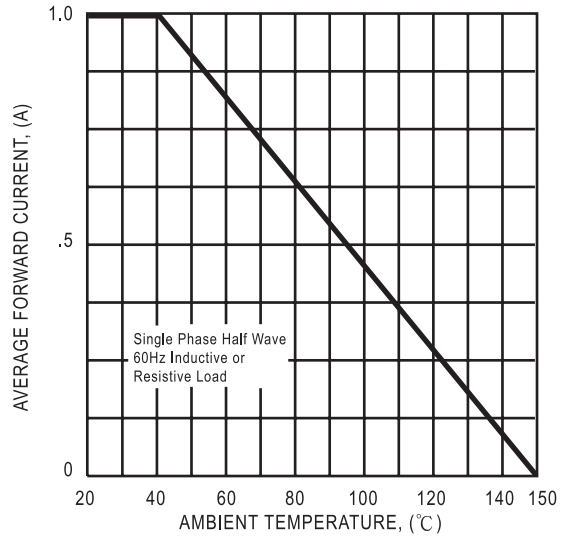

FIG. 3 - TYPICAL INSTANTANEOUS FORWARD CHARACTERISTICS

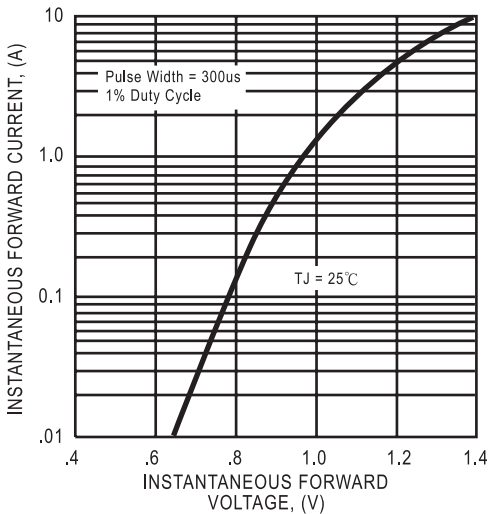
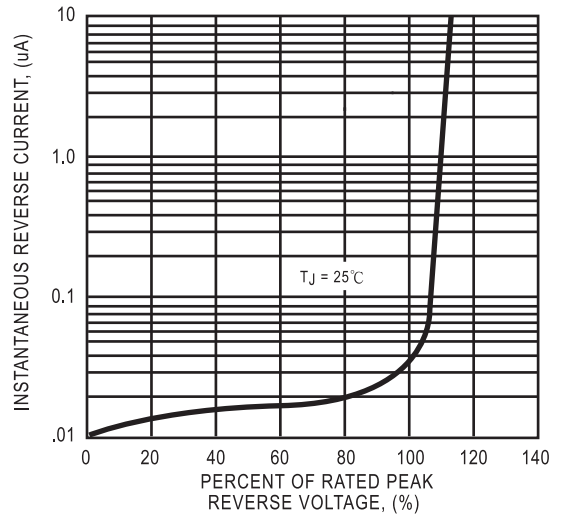

FIG. 4 - TYPICAL REVERSE CHARACTERISTICS



DC COMPONENTS CO., LTD.