

DATA SHEET

SKY73009: 400 – 3000 MHz Direct Quadrature Demodulator

Applications

- PCS, DCS, GSM/GPRS, and EDGE receivers
- Third Generation (3G) wireless communications
- Power amplifier feedback/linearization
- Wireless Local Loops (WLLs)
- Wireless Local Area Networks (WLANs)

Features

- High IIP2 and IIP3
- Wideband RF input frequency range (400 to 3000 MHz)
- Wideband LO input frequency range (400 to 3000 MHz)
- Integrated LO balun
- Integrated LO amplifier
- On-chip I/Q phase splitter
- Differential IF output supports direct interface to A/D circuitry
- AM demodulation immunity
- Single +3.0 V supply
- RFLGA™ (32 pin, 5 x 5 mm) Pb-free package (MSL3, 260 °C per JEDEC J-STD-020)

Description

Skyworks SKY73009 is an integrated, broadband, high-dynamic range quadrature demodulator for use in various wireless communication system applications. The SKY73009 can perform quadrature demodulation of RF input signals from 400 to 3000 MHz directly to baseband frequencies. The quadrature outputs are differential and can be directly connected to most commonly available A/D converters.

The high dynamic range and second order Input Intercept Point (IIP2) value of the SKY73009 make it ideal for use in direct conversion and low Intermediate Frequency (IF) receivers.

Figure 1 shows a functional block diagram for the SKY73009. The device package and pinout for the 32-pin RF Land Grid Array (RFLGA) are shown in Figure 2.



Skyworks offers lead (Pb)-free, RoHS (Restriction of Hazardous Substances) compliant packaging.

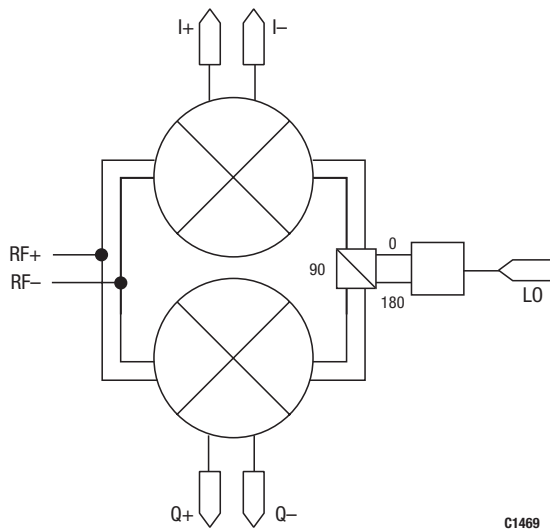

Figure 1. SKY73009 Functional Block Diagram

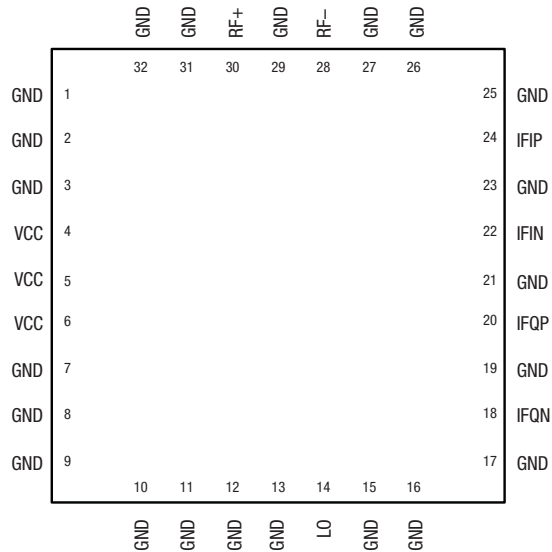

Figure 2. SKY73009 Pinout- 32-Pin RFLGA Package (Top View)

Table 1. SKY73009 Signal Descriptions

Pin #	Name	Description	Pin #	Name	Description
1	GND	Ground	17	GND	Ground
2	GND	Ground	18	IFQN	Negative quadrature IF output
3	GND	Ground	19	GND	Ground
4	VCC	+3 VDC supply	20	IFQP	Positive quadrature IF output
5	VCC	+3 VDC supply	21	GND	Ground
6	VCC	+3 VDC supply	22	IFIN	Negative in-phase IF output
7	GND	Ground	23	GND	Ground
8	GND	Ground	24	IFIP	Positive in-phase IF output
9	GND	Ground	25	GND	Ground
10	GND	Ground	26	GND	Ground
11	GND	Ground	27	GND	Ground
12	GND	Ground	28	RF-	Negative RF input
13	GND	Ground	29	GND	Ground
14	LO	LO input	30	RF+	Positive RF input
15	GND	Ground	31	GND	Ground
16	GND	Ground	32	GND	Ground

Table 2. SKY73009 Absolute Maximum Ratings
(T_A = +25 °C, unless otherwise noted)

Parameter	Symbol	Min	Typical	Max	Units
+3 V supply voltage	VCC	2.7		3.6	V
Power dissipation	P _D		210	320	mW
RF input power	P _{RFIN}			18	dBm
LO input power	P _{LOIN}		0	6	dBm
Operating case temperature	T _{OPR}	-40		+85	°C
Storage case temperature	T _{STG}	-40	0	+125	°C

Note: Exposure to maximum rating conditions for extended periods may reduce device reliability. There is no damage to device with only one parameter set at the limit and all other parameters set at or below their nominal values.

Equivalent Input Circuits

An equivalent circuit for the RF input of the SKY73009 is shown in Figure 3. The equivalent circuit for the Local Oscillator (LO) input is shown in Figure 4. An internal balun is used to convert the single-ended LO input into a differential signal before being buffered inside the device.

Electrical and Mechanical Specifications

Signal pin assignments and functional pin descriptions are provided in Table 1. The absolute maximum ratings of the SKY73009 are provided in Table 2 and the recommended operating conditions provided in Table 3. Electrical characteristics of the SKY73009 are provided in Table 4.

The typical performance of the SKY73009 with respect to frequency is illustrated in Figures 5 through 54. Figure 62

provides the package dimensions for the 32-pin RFLGA, and Figure 63 provides the tape and reel dimensions.

Package and Handling Information

Since the device package is sensitive to moisture absorption, it is baked and vacuum packed before shipping. Instructions on the shipping container label regarding exposure to moisture after the container seal is broken must be followed. Otherwise, problems related to moisture absorption may occur when the part is subjected to high temperature during solder assembly.

The SKY73009 is rated to Moisture Sensitivity Level 3 (MSL3) at 260 °C. It can be used for lead or lead-free soldering. For additional information, refer to the Skyworks Application Note, *PCB Design & SMT Assembly/Rework Guidelines for RFLGA Packages*, document number 103147.

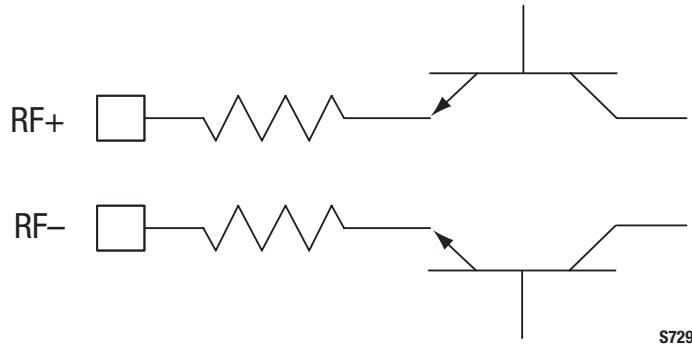

S729

Figure 3. Equivalent Circuit for the RF input

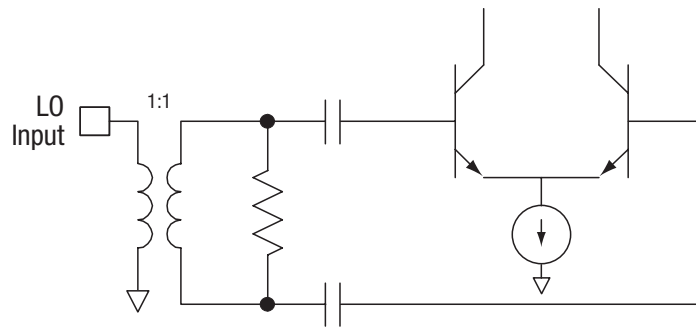

S730

Figure 4. Equivalent Circuit for The LO input.

Care must be taken when attaching this product, whether it is done manually or in a production solder reflow environment. Production quantities of this product are shipped in a standard tape and reel format. For packaging details, refer to the Skyworks Application Note *Tape and Reel*, document number 101568.

Electrostatic Discharge (ESD) Sensitivity

The SKY73009 is a static-sensitive electronic device. Do not operate or store near strong electrostatic fields. Take proper ESD precautions.

Table 3. SKY73009 Recommended Operating Conditions

Parameter	Symbol	Min	Typical	Max	Units
+3 V supply voltage	VCC	2.7	3.0	3.3	V
Current consumption	I _{CC}		75		mA
Operating case temperature	T _{OPR}	-40		+85	°C

Table 4. SKY73009 Electrical Characteristics
(VCC = 3 V, IF = 10 MHz, LO Input Power = 0 dBm, Tc = 25 °C, Zo = 50 Ω, unless otherwise noted)

Parameter	Symbol	Test Conditions	Min	Typical	Max	Units
RF input frequency range			400		3000	MHz
LO input frequency range (Note 1)			400		3000	MHz
IF frequency range			DC		250	MHz
I/Q amplitude imbalance			-0.3		+0.3	dB
I/Q phase error				1		deg
IF output impedance (Note 2)				500		Ω
LO to RF isolation				50		dB
IF output DC level		Over process and operating temperature	0.95	1.20	1.55	V
RF Input (900 MHz)						
Voltage conversion gain			0	2		dB
SSB Noise Figure	NF			14	16	dB
2 nd Order Input Intercept Point	IIP2			60		dBm
3 rd Order Input Intercept Point	IIP3		24	27		dBm
-1 dB compression point			10	12		dBm
RF input VSWR				1.5:1	2.0:1	
LO input VSWR				1.5:1	2.0:1	
Noise floor				-166		dBm/Hz
RF Input (1900 MHz)						
Voltage conversion gain			-0.7	+1.3		dB
SSB Noise Figure	NF			15	17	dB
2 nd Order Input Intercept Point	IIP2			60		dBm
3 rd Order Input Intercept Point	IIP3		22	25		dBm
-1 dB compression point			11	13		dBm
RF input VSWR				1.5:1	2.0:1	
LO input VSWR				1.5:1	2.0:1	
Noise floor				-163		dBm/Hz

Note 1: For operation at LO frequencies <550 MHz and >2500 MHz, an LO power of +3 dBm must be used.

Note 2: Differential IFI and IFQ output impedance without the use of a 9:1 impedance ratio balun.

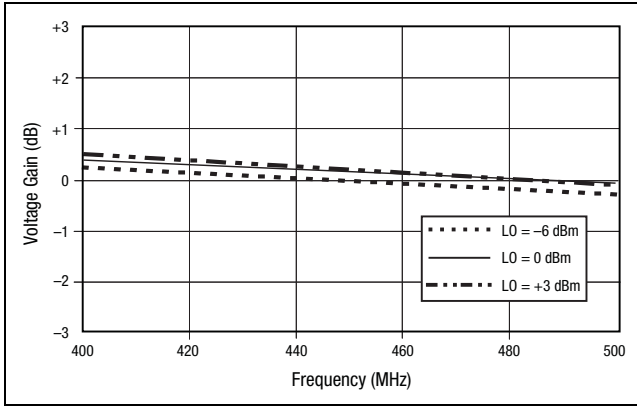

Figure 5. Voltage Conversion Gain vs Frequency: 400-500 MHz (Mini-Circuits TC1-1 Balun on RF Port)

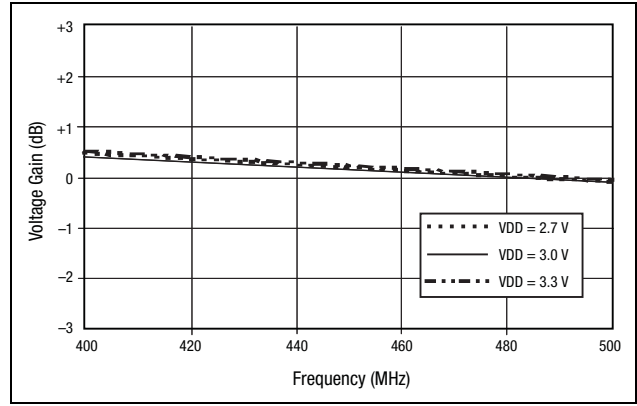

Figure 6. Voltage Conversion Gain vs Frequency: 400-500 MHz (Mini-Circuits TC1-1 Balun on RF Port)

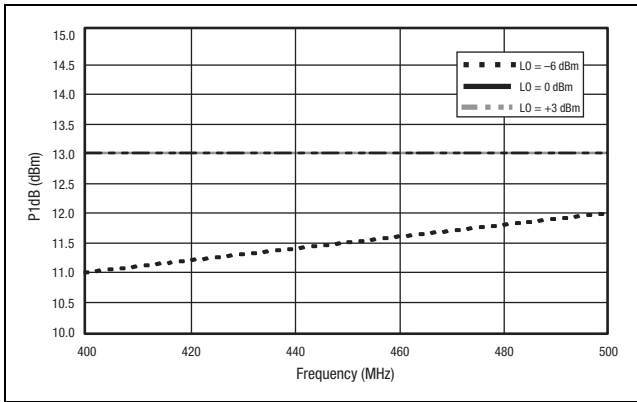

Figure 7. 1 dB Compression Point vs Frequency: 400-500 MHz (Mini-Circuits TC1-1 Balun on RF Port)

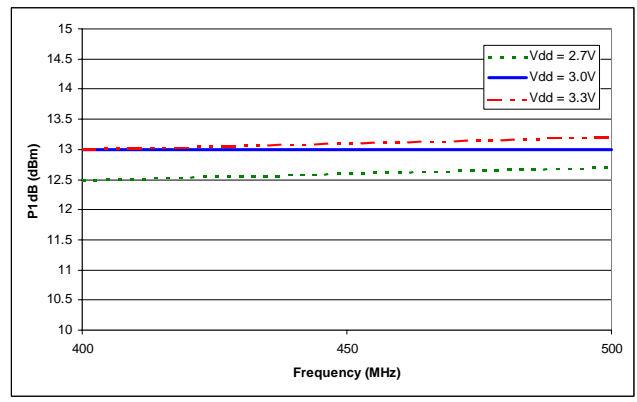

Figure 8. 1 dB Compression Point vs Frequency: 400-500 MHz (Mini-Circuits TC1-1 Balun on RF Port)

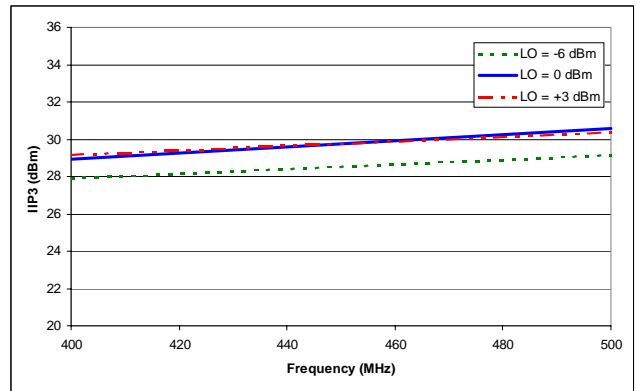

Figure 9. IIP3 vs Frequency: 400-500 MHz (Mini-Circuits TC1-1 Balun on RF Port)

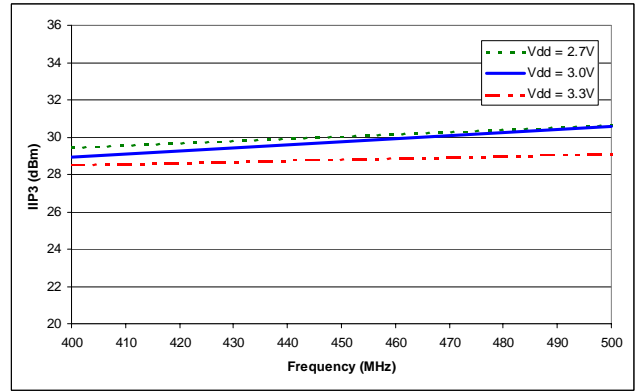

Figure 10. IIP3 vs Frequency: 400-500 MHz (Mini-Circuits TC1-1 Balun on RF Port)

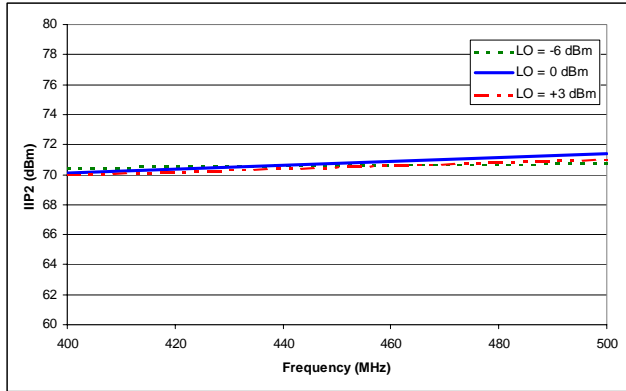

Figure 11. IIP2 vs Frequency: 400-500 MHz (Mini-Circuits TC1-1 Balun on RF Port)

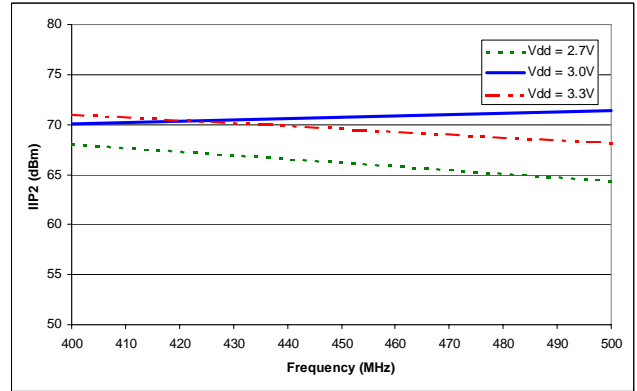

Figure 12. IIP2 vs Frequency: 400-500 MHz (Mini-Circuits TC1-1 Balun on RF Port)

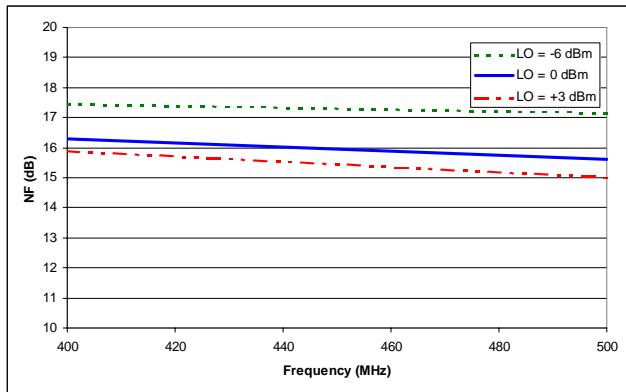

Figure 13. NF vs Frequency: 400-500 MHz (Mini-Circuits TC1-1 Balun on RF Port)

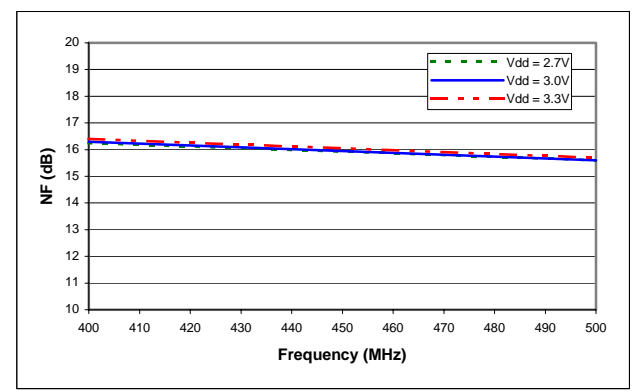

Figure 14. NF vs Frequency: 400-500 MHz (Mini-Circuits TC1-1 Balun on RF Port)

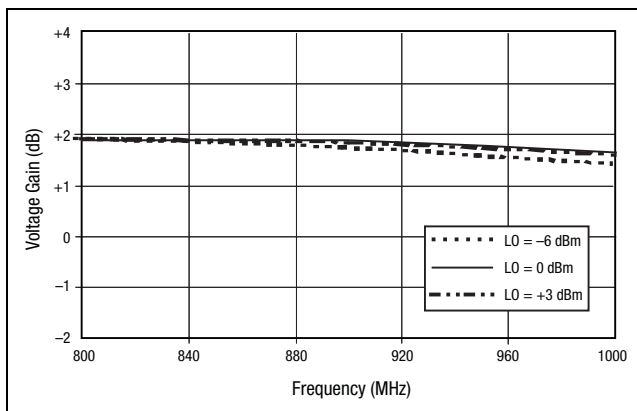

Figure 15. Voltage Conversion Gain vs Frequency: 800-1000 MHz (Murata LDB15C500A0900 Balun on RF Port)

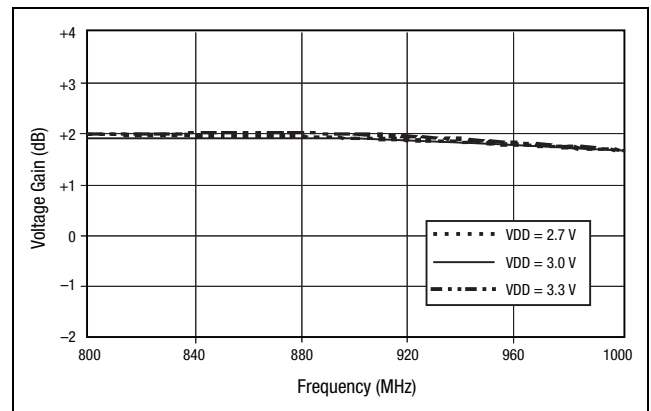

Figure 16. Voltage Conversion Gain vs Frequency: 800-1000 MHz (Murata LDB15C500A0900 Balun on RF Port)

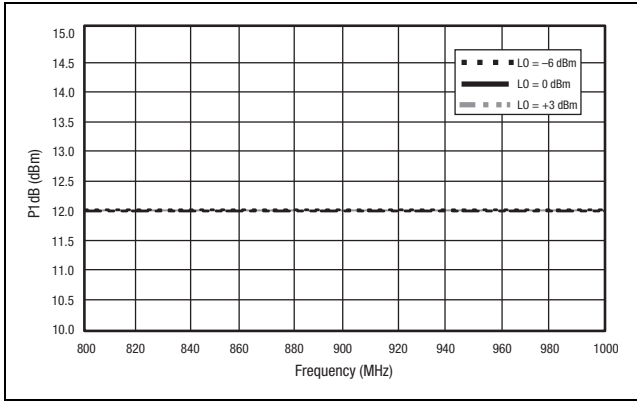

Figure 17. 1 dB Compression Point vs Frequency: 800-1000 MHz (Murata LDB15C500A0900 Balun on RF Port)

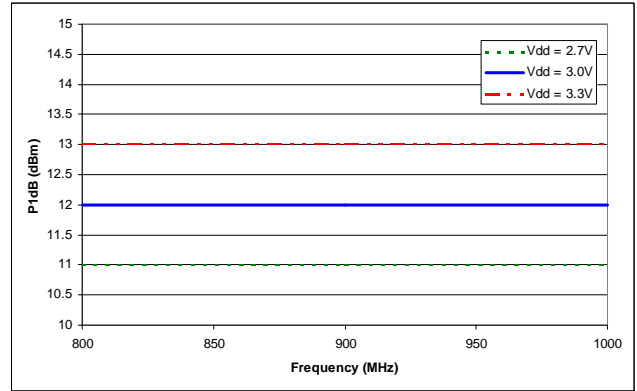

Figure 18. 1 dB Compression Point vs Frequency: 800-1000 MHz (Murata LDB15C500A0900 Balun on RF Port)

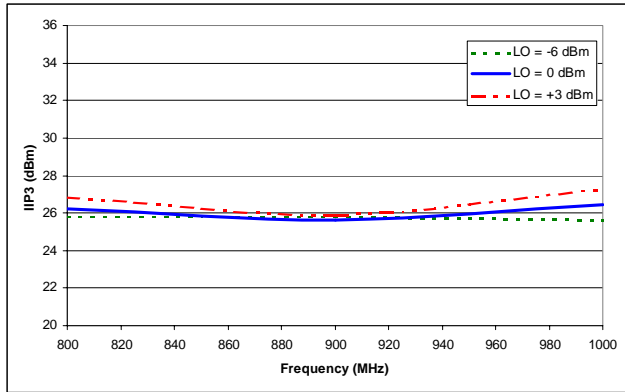

Figure 19. IIP3 vs Frequency: 800-1000 MHz (Murata LDB15C500A0900 Balun on RF Port)

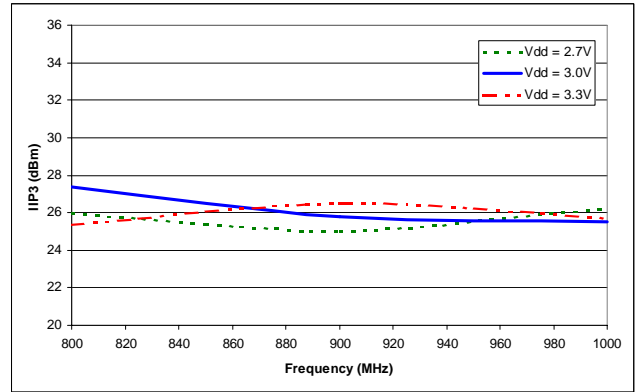

Figure 20. IIP3 vs Frequency: 800-1000 MHz (Murata LDB15C500A0900 Balun on RF Port)

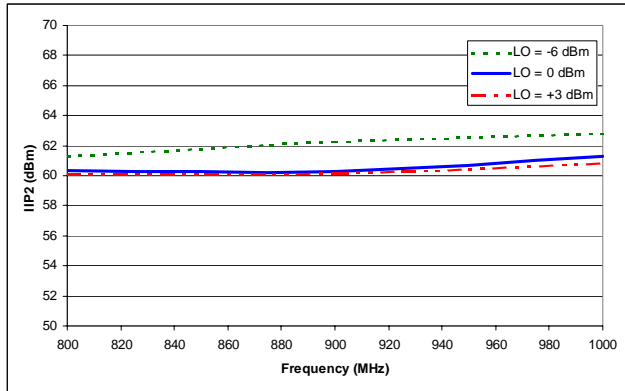

Figure 21. IIP2 vs Frequency: 800-1000 MHz (Murata LDB15C500A0900 Balun on RF Port)

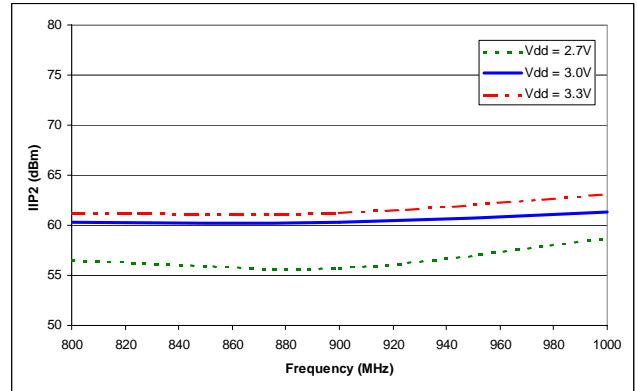

Figure 22. IIP2 vs Frequency: 800-1000 MHz (Murata LDB15C500A0900 Balun on RF Port)

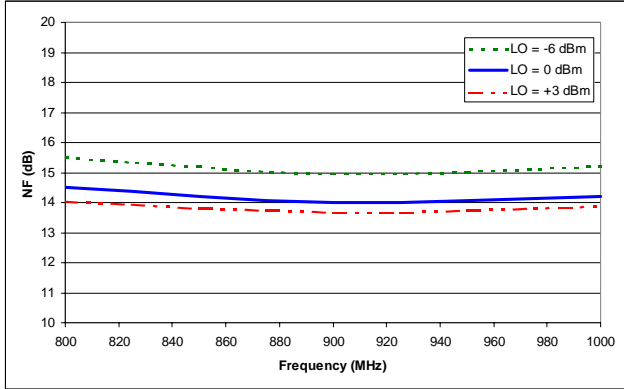

Figure 23. NF vs Frequency: 800-1000 MHz (Murata LDB15C500A0900 Balun on RF Port)

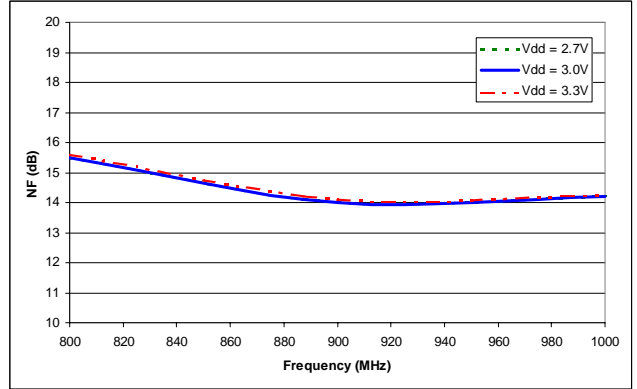

Figure 24. NF vs Frequency: 800-1000 MHz (Murata LDB15C500A0900 Balun on RF Port)

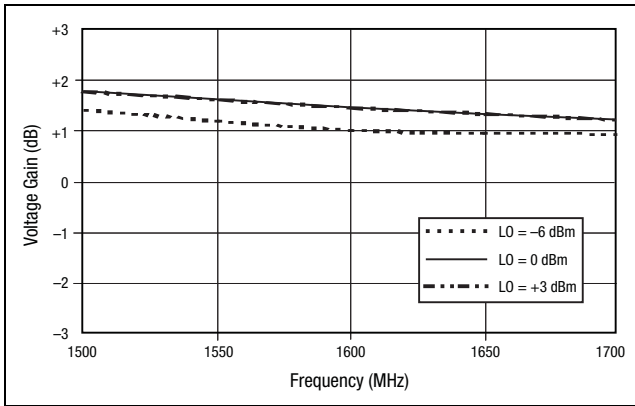

Figure 25. Voltage Conversion Gain vs Frequency: 1500-1700 MHz (Murata LDB15C500A1600 Balun on RF Port)

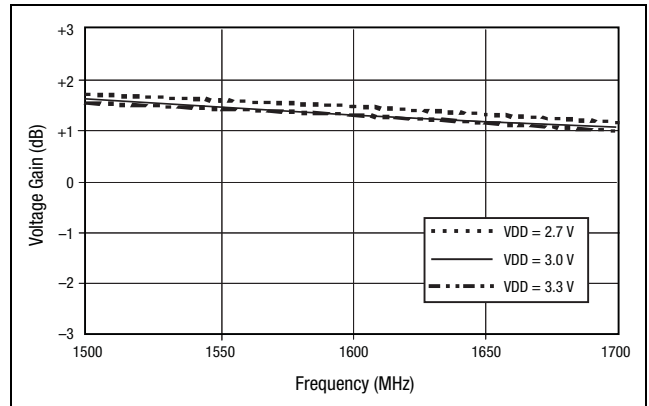

Figure 26. Voltage Conversion Gain vs Frequency: 1500-1700 MHz (Murata LDB15C500A1600 Balun on RF Port)

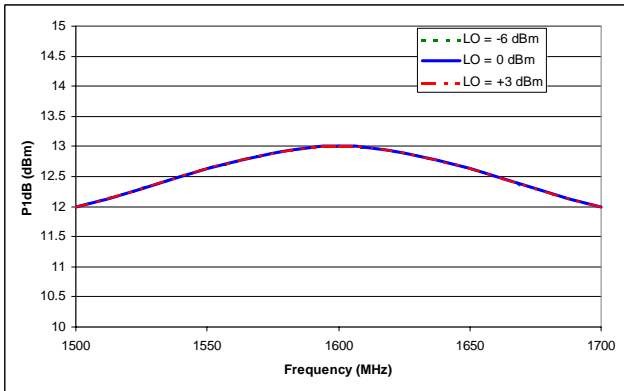

Figure 27. 1 dB Compression Point vs Frequency: 1500-1700 MHz (Murata LDB15C500A1600 Balun on RF Port)

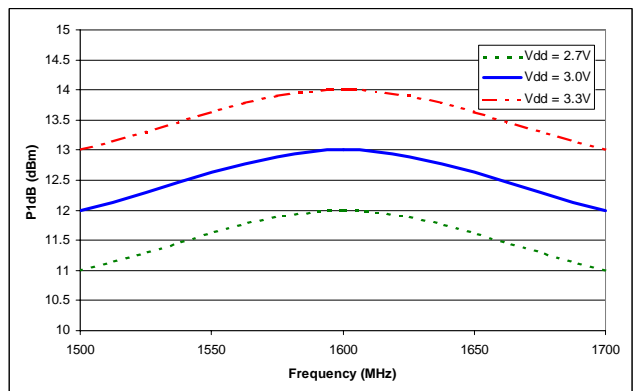

Figure 28. 1 dB Compression Point vs Frequency: 1500-1700 MHz (Murata LDB15C500A1600 Balun on RF Port)

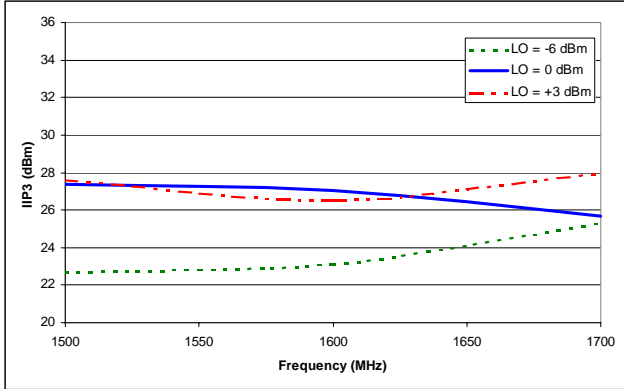

Figure 29. IIP3 vs Frequency: 1500-1700 MHz (Murata LDB15C500A1600 Balun on RF Port)

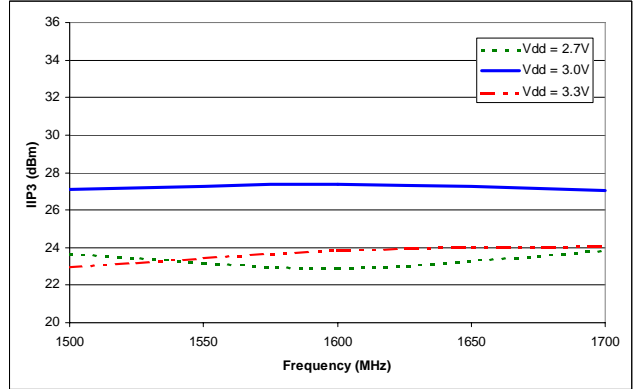

Figure 30. IIP3 vs Frequency: 1500-1700 MHz (Murata LDB15C500A1600 Balun on RF Port)

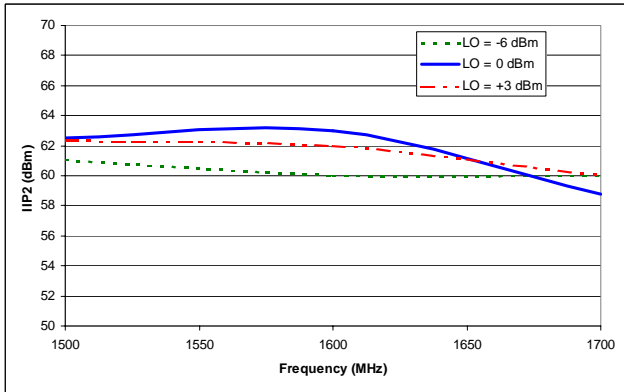

Figure 31. IIP2 vs Frequency: 1500-1700 MHz (Murata LDB15C500A1600 Balun on RF Port)

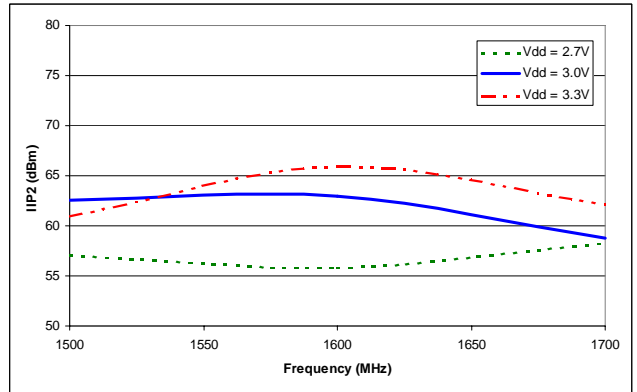

Figure 32. IIP2 vs Frequency: 1500-1700 MHz (Murata LDB15C500A1600 Balun on RF Port)

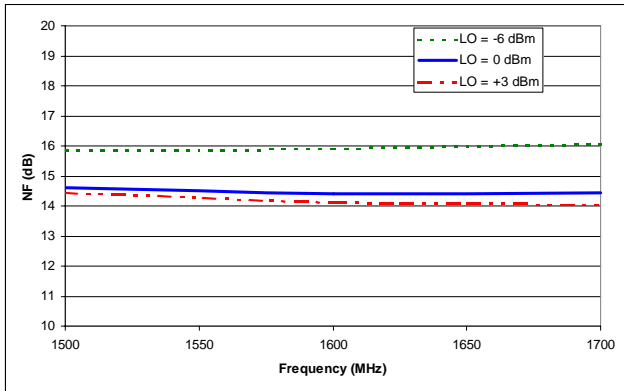

Figure 33. NF vs Frequency: 1500-1700 MHz (Murata LDB15C500A1600 Balun on RF Port)

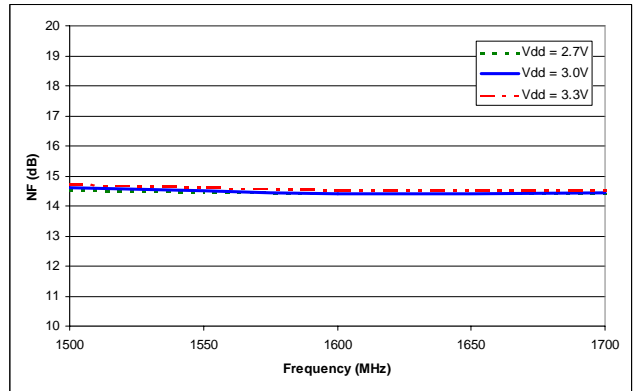

Figure 34. NF vs Frequency: 1500-1700 MHz (Murata LDB15C500A1600 Balun on RF Port)

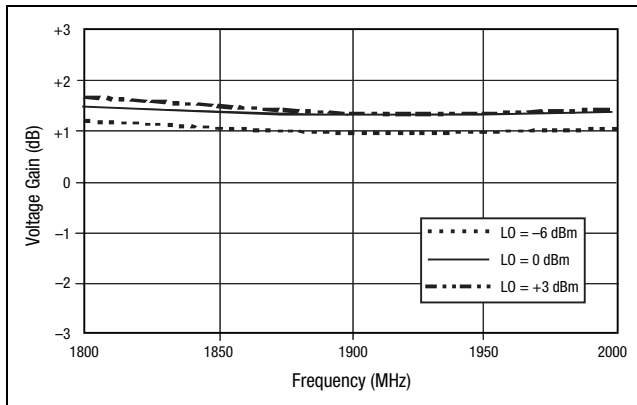

Figure 35. Voltage Conversion Gain vs Frequency: 1800-2000 MHz (Murata LDB15C500A1900 Balun on RF Port)

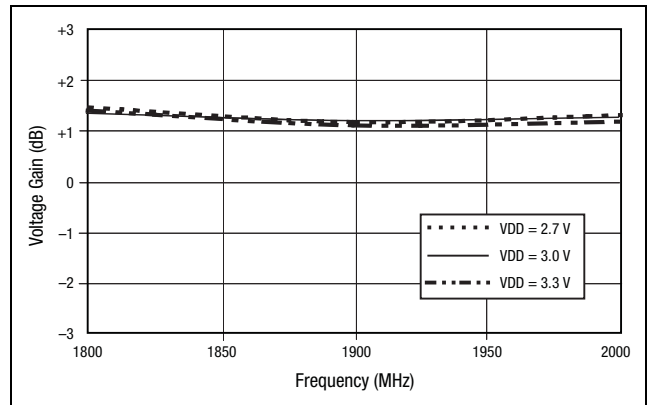

Figure 36. Voltage Conversion Gain vs Frequency: 1800-2000 MHz (Murata LDB15C500A1900 Balun on RF Port)

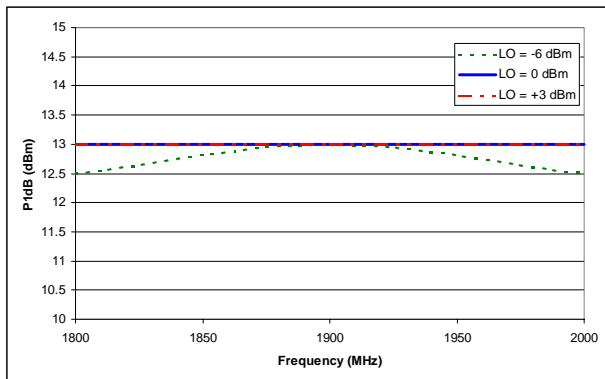

Figure 37. 1 dB Compression Point vs Frequency: 1800-2000 MHz (Murata LDB15C500A1900 Balun on RF Port)

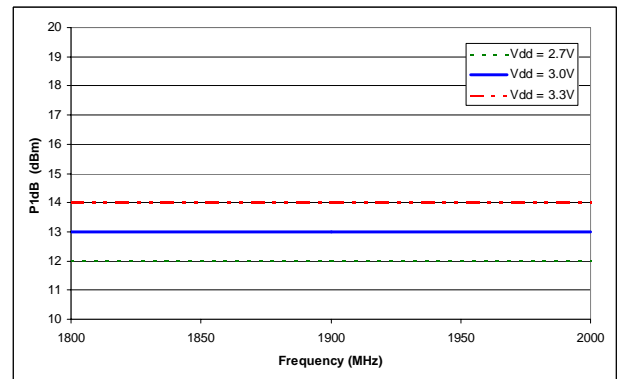

Figure 38. 1 dB Compression Point vs Frequency: 1800-2000 MHz (Murata LDB15C500A1900 Balun on RF Port)

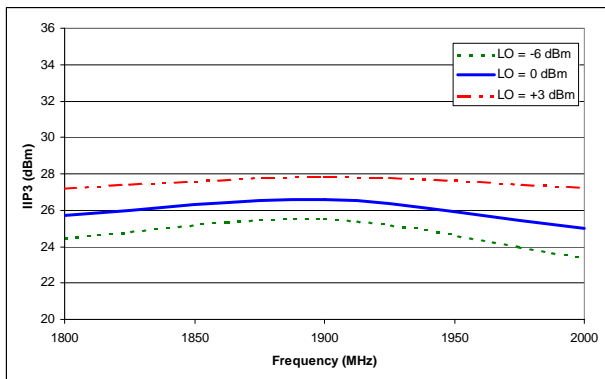

Figure 39. IIP3 vs Frequency: 1800-2000 MHz (Murata LDB15C500A1900 Balun on RF Port)

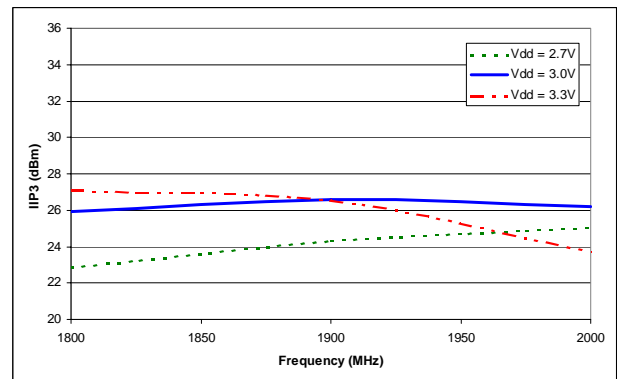

Figure 40. IIP3 vs Frequency: 1800-2000 MHz (Murata LDB15C500A1900 Balun on RF Port)

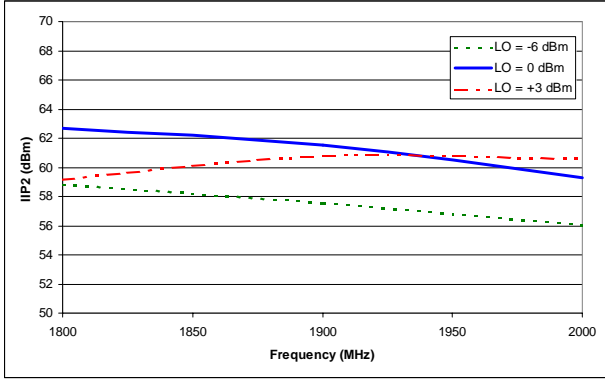

Figure 41. IIP2 vs Frequency: 1800-2000 MHz (Murata LDB15C500A1900 Balun on RF Port)

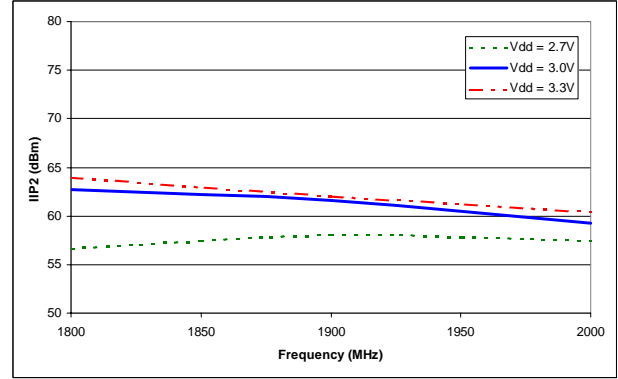

Figure 42. IIP2 vs Frequency: 1800-2000 MHz (Murata LDB15C500A1900 Balun on RF Port)

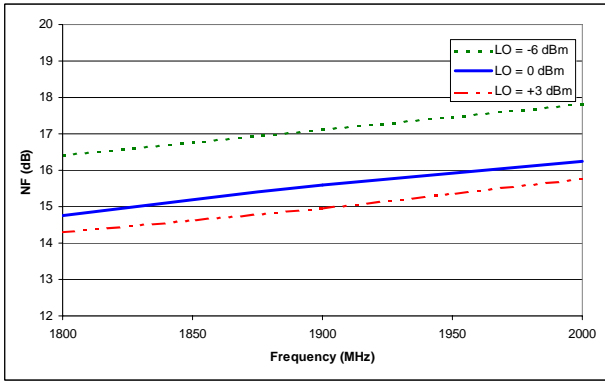

Figure 43. NF vs Frequency: 1800-2000 MHz (Murata LDB15C500A1900 Balun on RF Port)

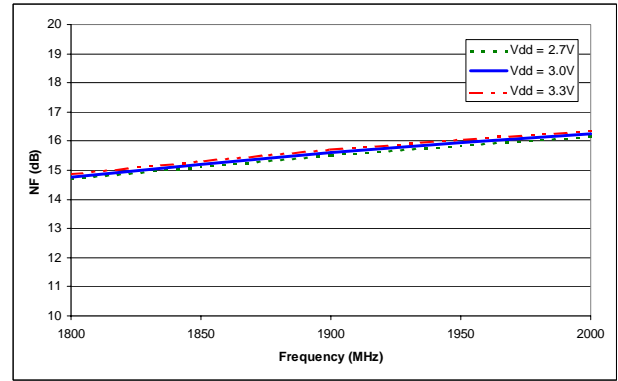

Figure 44. NF vs Frequency: 1800-2000 MHz (Murata LDB15C500A1900 Balun on RF Port)

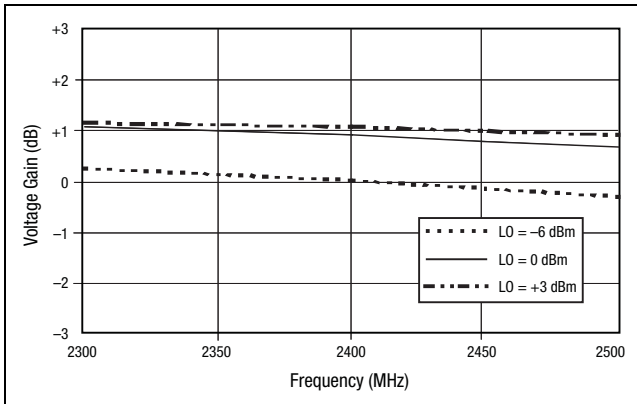

Figure 45. Voltage Conversion Gain vs Frequency: 2300-2500 MHz (Murata LDB15C500A2400 Balun on RF Port)

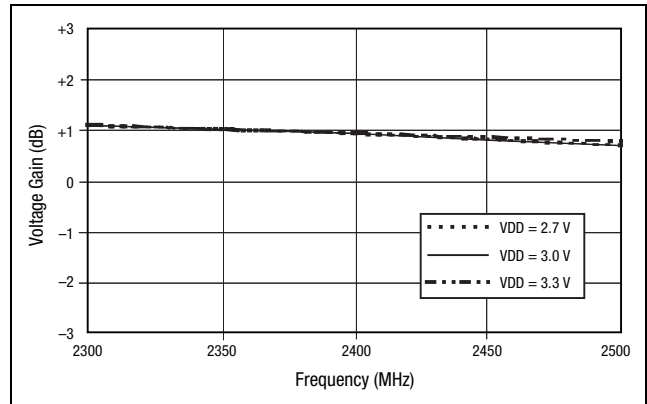

Figure 46. Voltage Conversion Gain vs Frequency: 2300-2500 MHz (Murata LDB15C500A2400 Balun on RF Port)

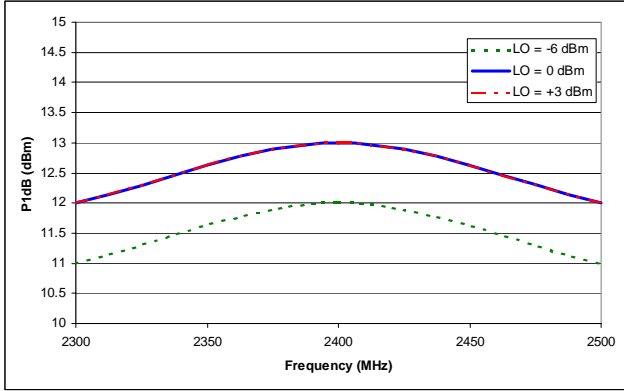

Figure 47. 1 dB Compression Point vs Frequency: 2300-2500 MHz (Murata LDB15C500A2400 Balun on RF Port)

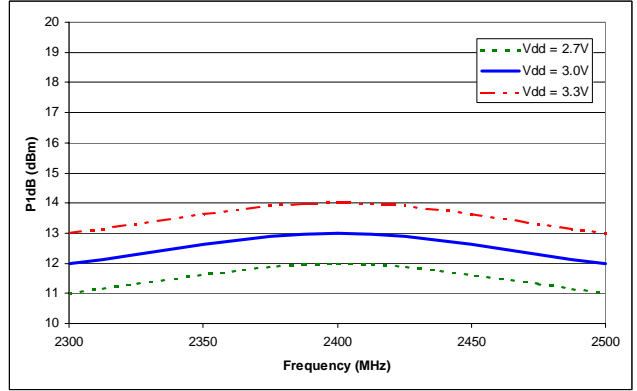

Figure 48. 1 dB Compression Point vs Frequency: 2300-2500 MHz (Murata LDB15C500A2400 Balun on RF Port)

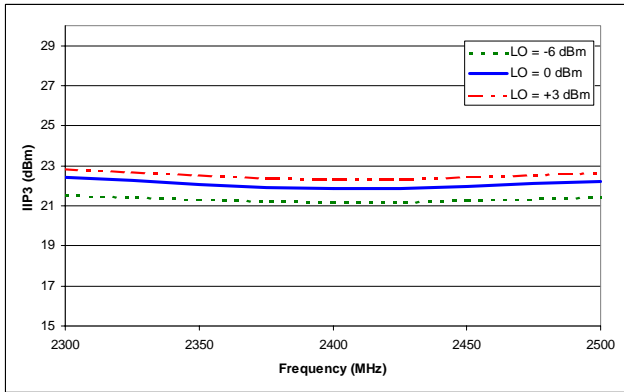

Figure 49. IIP3 vs Frequency: 2300-2500 MHz (Murata LDB15C500A2400 Balun on RF Port)

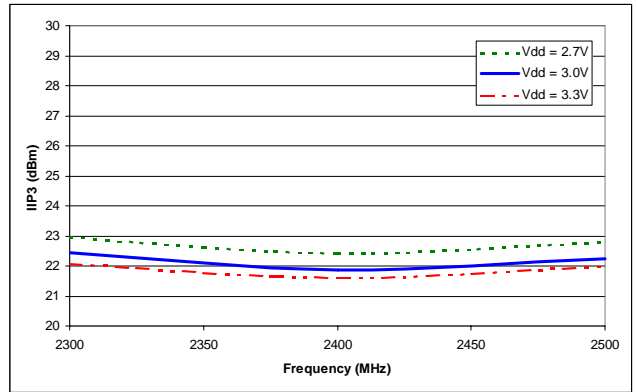

Figure 50. IIP3 vs Frequency: 2300-2500 MHz (Murata LDB15C500A2400 Balun on RF Port)

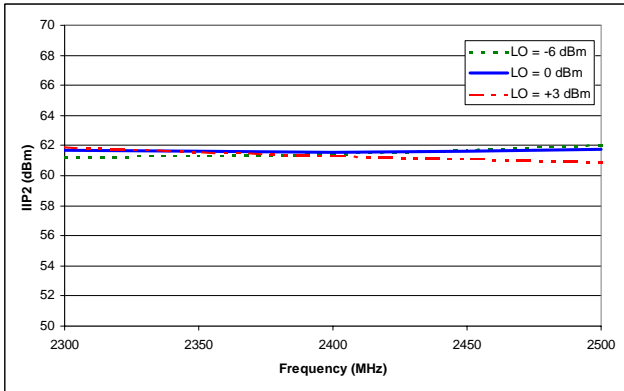

Figure 51. IIP2 vs Frequency: 2300-2500 MHz (Murata LDB15C500A2400 Balun on RF Port)

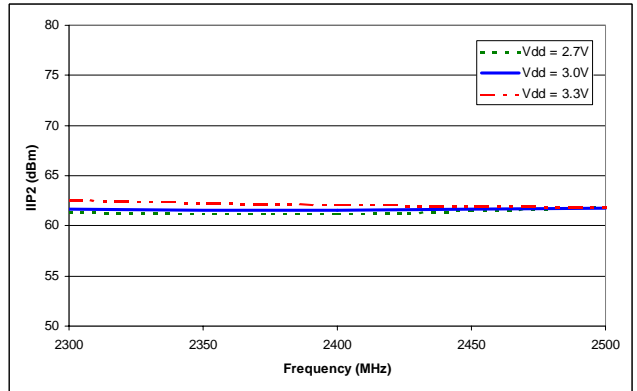
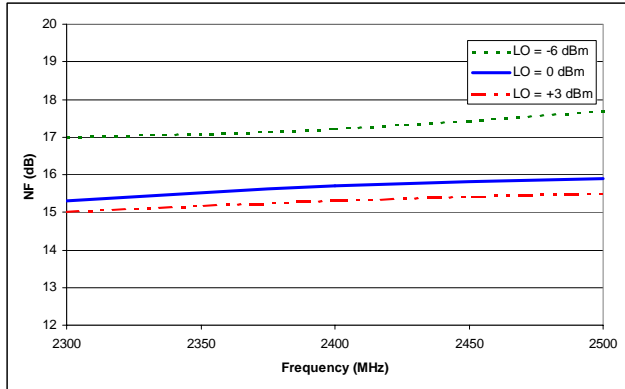
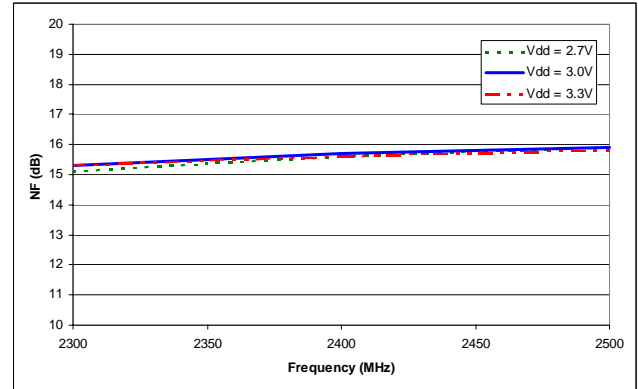

Figure 52. IIP2 vs Frequency: 2300-2500 MHz (Murata LDB15C500A2400 Balun on RF Port)



**Figure 53. NF vs Frequency: 2300-2500 MHz
(Murata LDB15C500A2400 Balun on RF Port)**



**Figure 54. NF vs Frequency: 2300-2500 MHz
(Murata LDB15C500A2400 Balun on RF Port)**

Evaluation Board Description

The SKY73009 Evaluation Board is used to test the performance of the SKY73009 direct quadrature demodulator. There are three Evaluation Boards for this device, each configured for a specific frequency range. Schematic diagrams and Bills of Materials (BOMs) for each board are presented in the following Figures and Tables:

- Figure 55 and Table 5 (800-1000 MHz)
- Figure 56 and Table 6 (1500-2500 MHz)
- Figure 57 and Table 7 (custom frequency)

The Evaluation Board assembly diagram is shown in Figure 58 (800-1000 MHz), Figure 59 (1500-2500 MHz), and Figure 60 (custom frequency).

Circuit Design Considerations

The following design considerations are general in nature and must be followed regardless of final use or configuration.

1. Paths to ground should be made as short as possible.
2. The ground pad of the SKY73009 direct quadrature demodulator has special electrical and thermal grounding requirements. This pad is the main thermal conduit for heat dissipation. Since the circuit board acts as the heat sink, it must shunt as much heat as possible from the device. As such, design the connection to the ground pad to dissipate the maximum wattage produced to the circuit board.
3. Two external output bypass capacitors are required on the VCC pin. The values of these capacitors will change with respect to the desired RF frequency. One capacitor should be used for low frequency bypassing and the other capacitor for high frequency bypassing. Special attention should be given

so that the smaller value capacitor does not go into self-resonance at the desired RF frequency.

4. The RF input must be driven differentially. A 1:1 impedance ratio balun is recommended with a center tap on the secondary side that is DC grounded.

Testing Procedure

Use the following procedure to set up the SKY73009 Evaluation Board for testing. Refer to Figure 61 for guidance:

1. Connect a +3.0 VDC power supply using an insulated supply cable. If available, enable the current limiting function of the power supply to 100 mA.
2. Connect a signal generator to the RF signal input port. Set it to the desired RF frequency at a power level of 0 dBm to the Evaluation Board but do NOT enable the RF signal.
3. Connect a signal generator to the LO signal input port. Set to the desired LO frequency at a power level of 0 dBm, but do not enable.
4. Connect a spectrum analyzer to the IFI signal output port and terminate the IFQ signal input port in 50 Ω .
5. Enable the power supply.
6. Enable the LO input signal.
7. Enable the RF signal.
8. Take measurements and repeat these steps for channel Q.

CAUTION: *If any of the input signals exceed the rated maximum values, the SKY73009 Evaluation Board can be permanently damaged.*

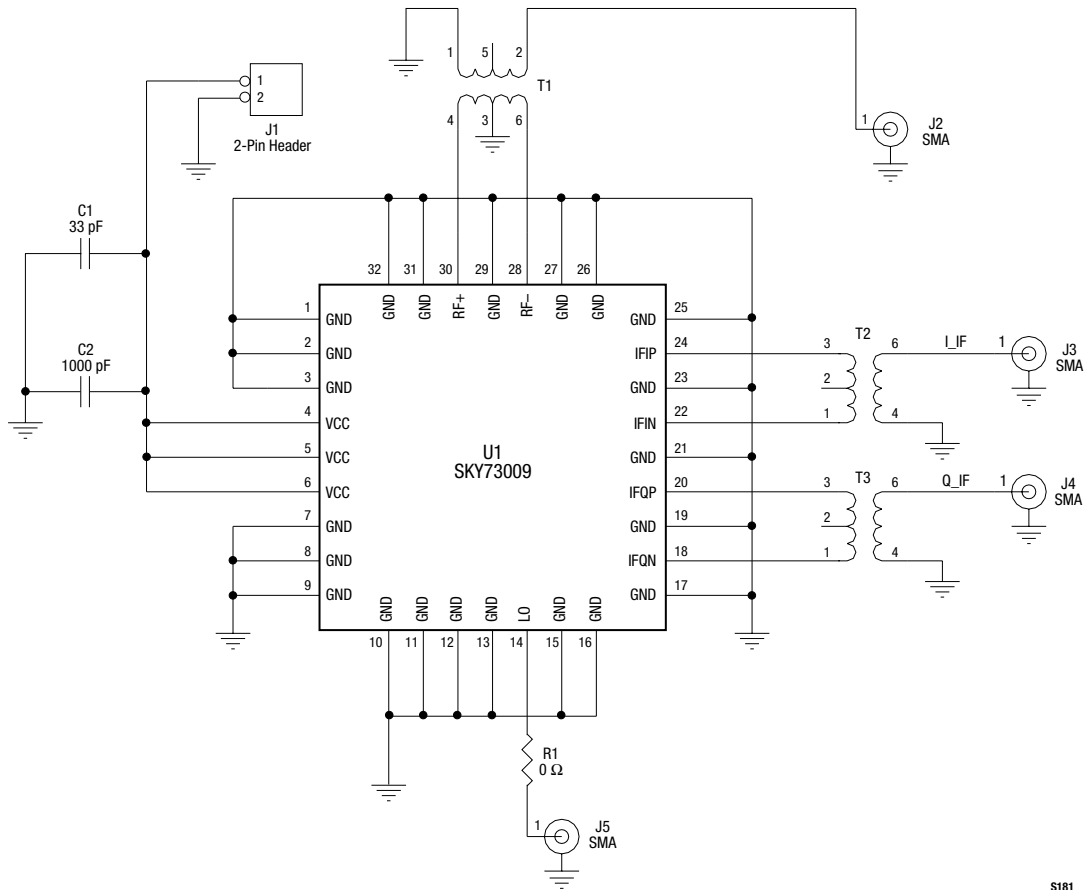

S181

Figure 55. SKY73009 Evaluation Board Schematic (800-1000 MHz)

Table 5. SKY73009 Evaluation Board Component Values (800-1000 MHz)

Reference Designator	Quantity	Value	Manufacturer	Part Number
C1	1	33 pF (0603)		
C2	1	1000 pF (0603)		
J1	1	Two-pin header connector		
J2	1	SMA connector		
J3	1	SMA connector		
J4	1	SMA connector		
J5	1	SMA connector		
R1	1	0 Ω (0603)		
T1	1	1:1 (800-1000 MHz)	Murata	LDB31900M05C-417
T2	1	9:1	Mini-Circuits	TCM-9-1
T3	1	9:1	Mini-Circuits	TCM-9-1
U1	1	–	Skyworks	SKY73009-11

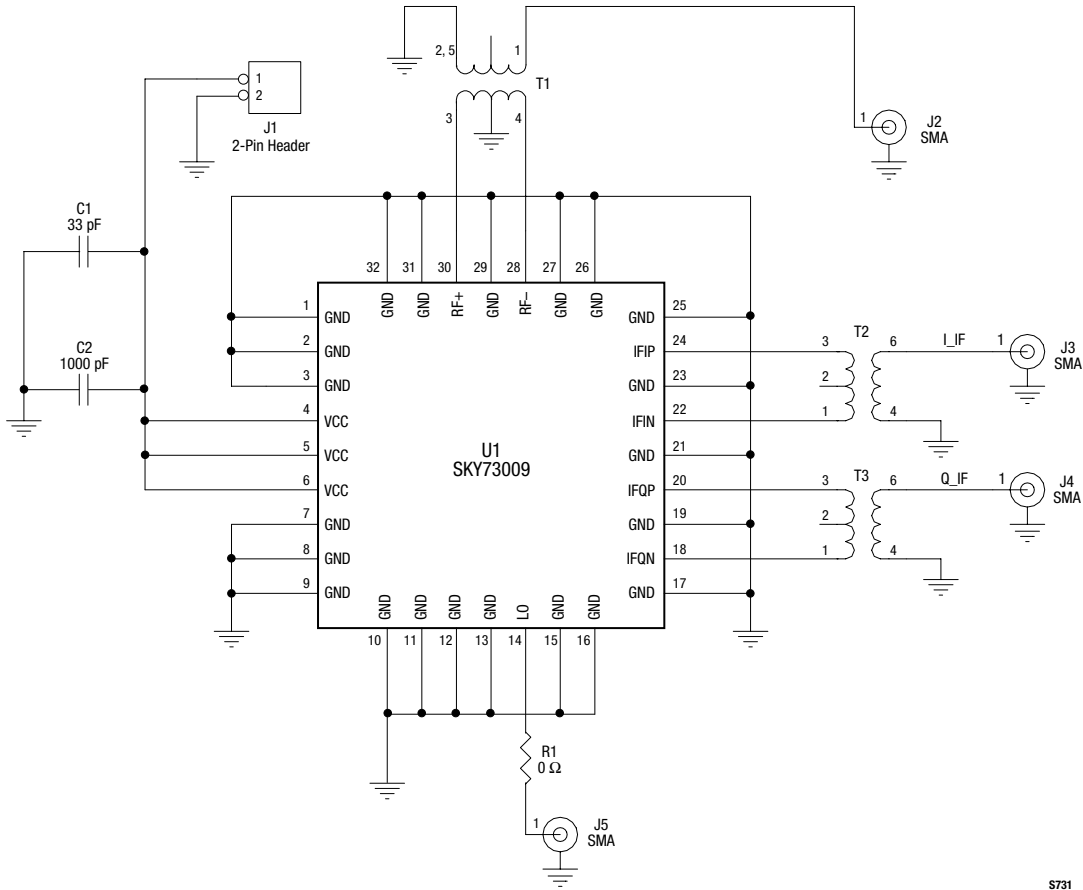

S731

Figure 56. SKY73009 Evaluation Board Schematic (1500-2500 MHz)

Table 6. SKY73009 Evaluation Board Component Values (1500-2500 MHz)

Reference Designator	Quantity	Value	Manufacturer	Part Number
C1	1	33 pF (0603)		
C2	1	1000 pF (0603)		
J1	1	Two-pin header connector		
J2	1	SMA connector		
J3	1	SMA connector		
J4	1	SMA connector		
J5	1	SMA connector		
R1	1	0 Ω (0603)		
T1	1	1:1 (1500-1700 MHz), or 1:1 (1800-2000 MHz), or 1:1 (2300-2500 MHz)	Murata	LDB211G6005C-001 LDB211G9005C-001 LDB211G4005C-001
T2	1	9:1	Mini-Circuits	TCM-9-1
T3	1	9:1	Mini-Circuits	TCM-9-1
U1	1	–	Skyworks	SKY73009-11

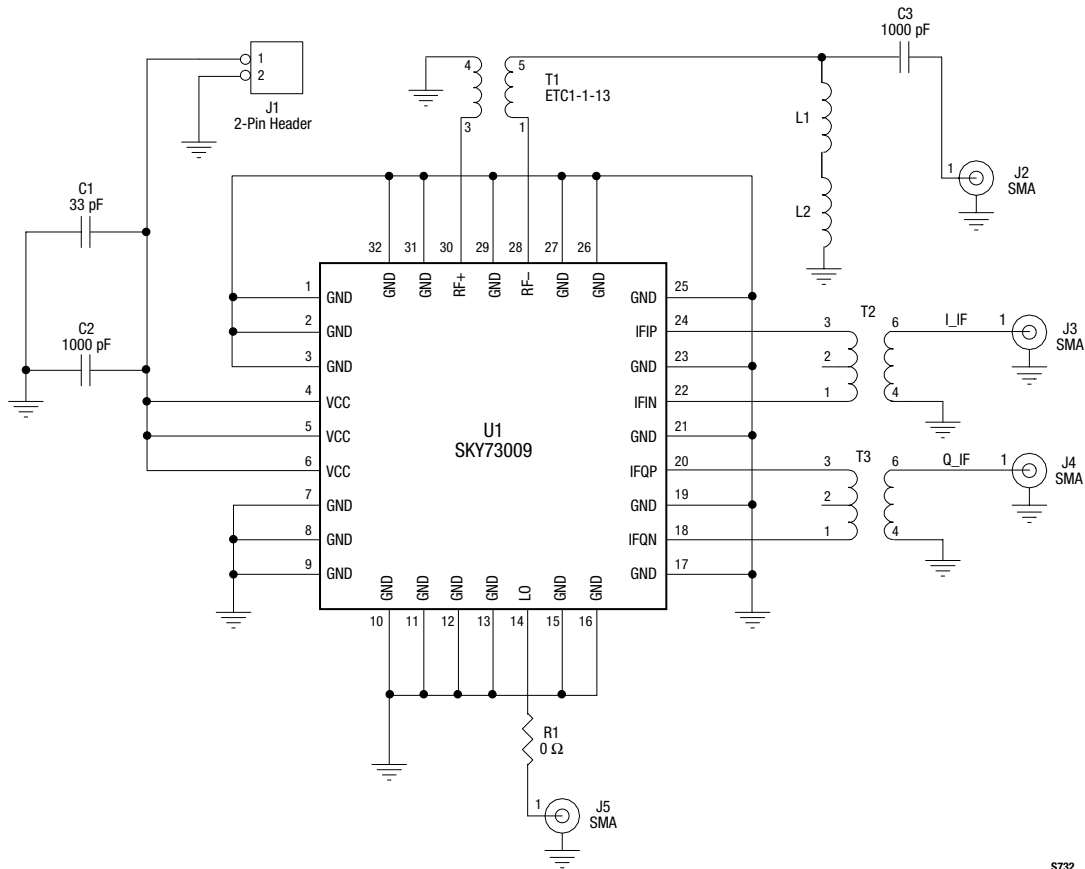

S732

Figure 57. SKY73009 Evaluation Board Schematic (Custom Frequency)

Table 7. SKY73009 Evaluation Board Component Values (Custom Frequency)

Reference Designator	Quantity	Value	Manufacturer	Part Number
C1	1	33 pF (0603)		
C2	1	1000 pF (0603)		
C3	1	33 pF (0603)		
J1	1	Two-pin header connector		
J2	1	SMA connector		
J3	1	SMA connector		
J4	1	SMA connector		
J5	1	SMA connector		
L1	1	Adjusted for best match at desired frequency		
L2	1	Adjusted for best match at desired frequency		
R1	1	0 Ω (0603)		
T1	1	1:1 (4.5-3000 MHz)	M/A-Com	ETC1-1-13
T2	1	9:1	Mini-Circuits	TCM-9-1
T3	1	9:1	Mini-Circuits	TCM-9-1
U1	1	–	Skyworks	SKY73009-11

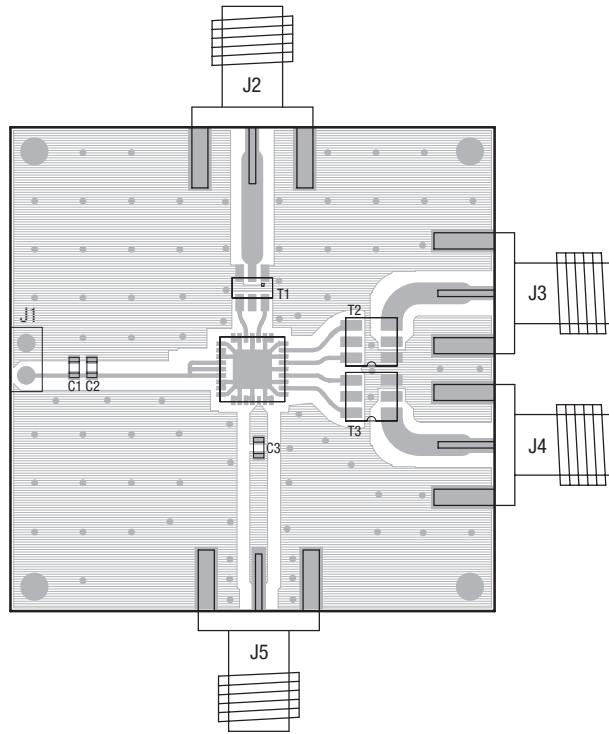

Component Placement

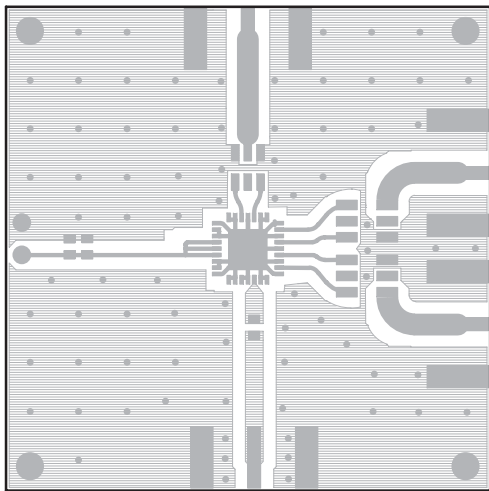

Top Layer

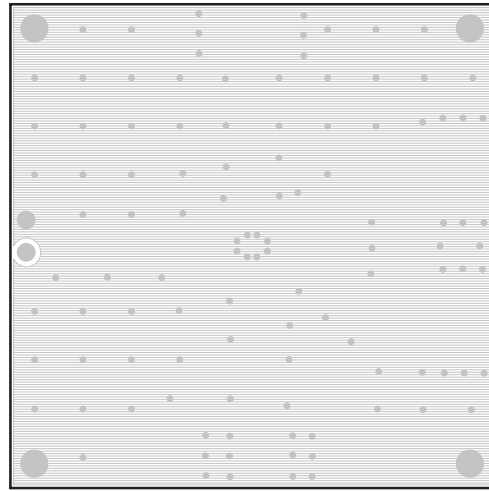

Bottom Layer

S733

Figure 58. SKY73009 Evaluation Board Assembly Diagram – 800-1000 MHz

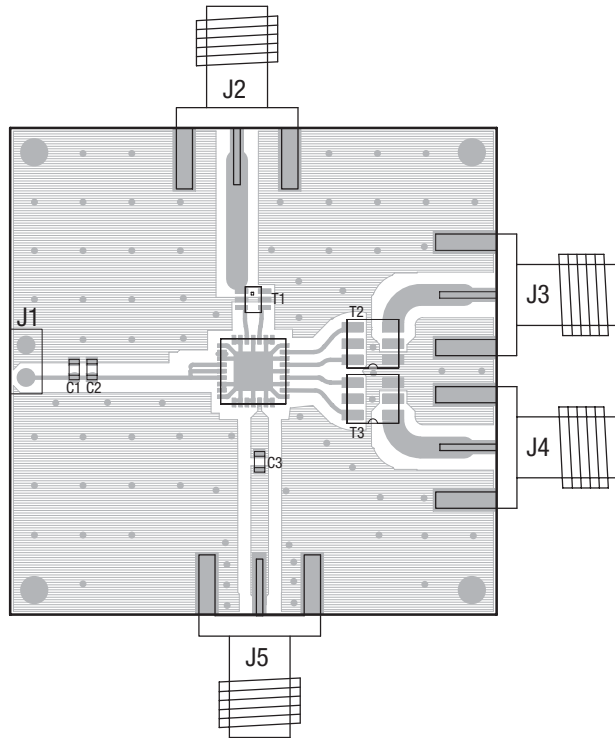

Component Placement

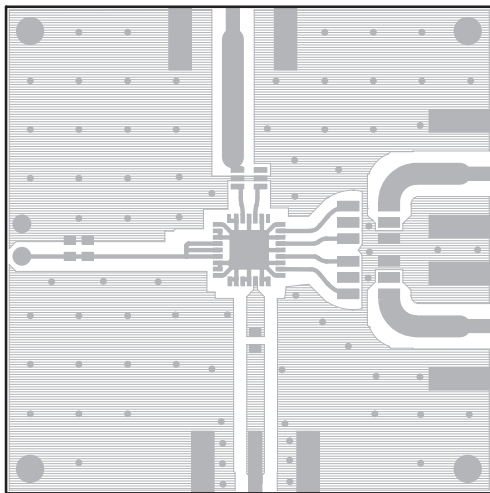

Top Layer

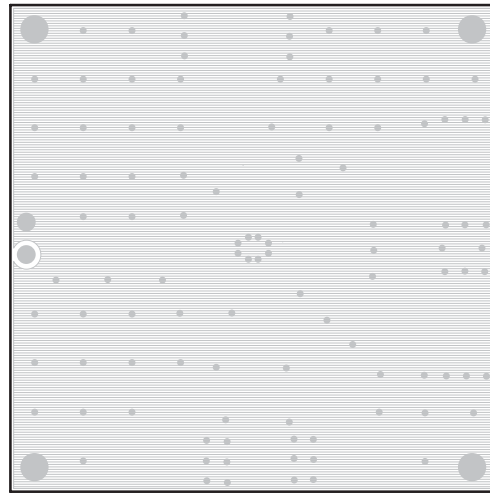

Bottom Layer

S734

Figure 59. SKY73009 Evaluation Board Assembly Diagram – 1500-2500 MHz

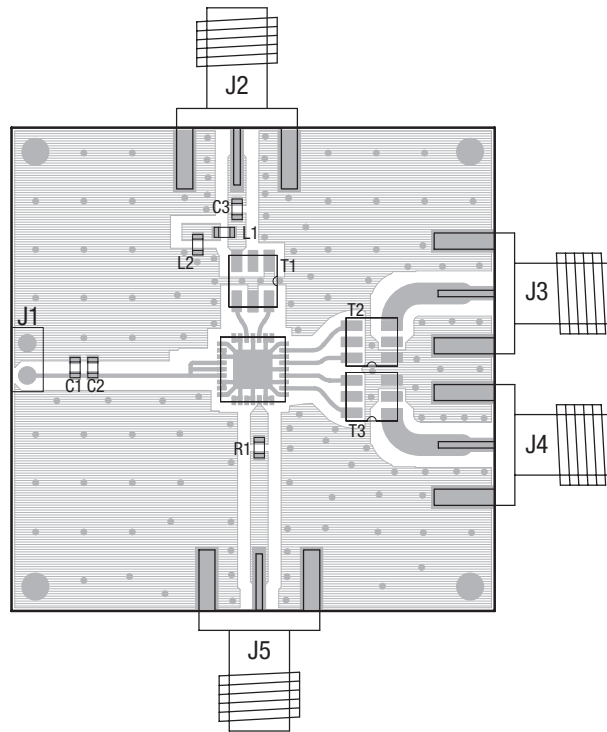

Component Placement

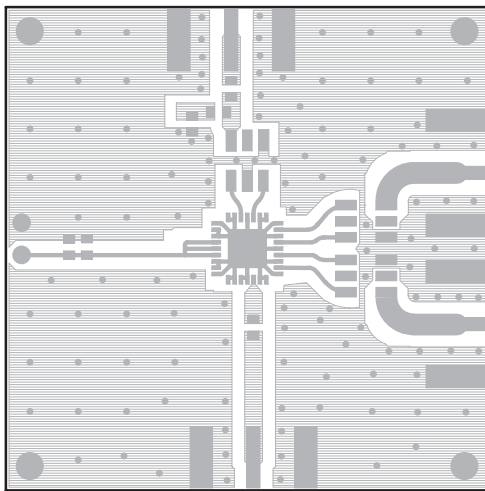

Top Layer

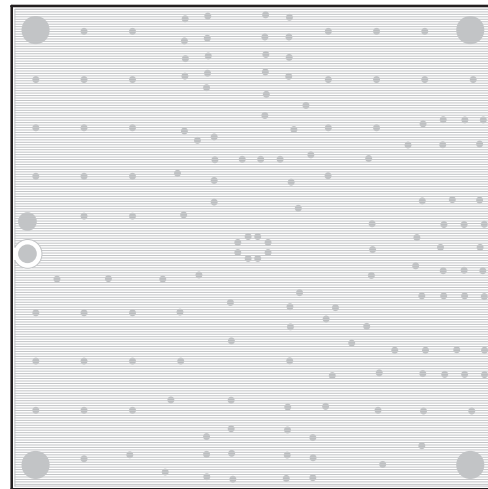

Bottom Layer

S735

Figure 60. SKY73009 Evaluation Board Assembly Diagram – Custom Frequency

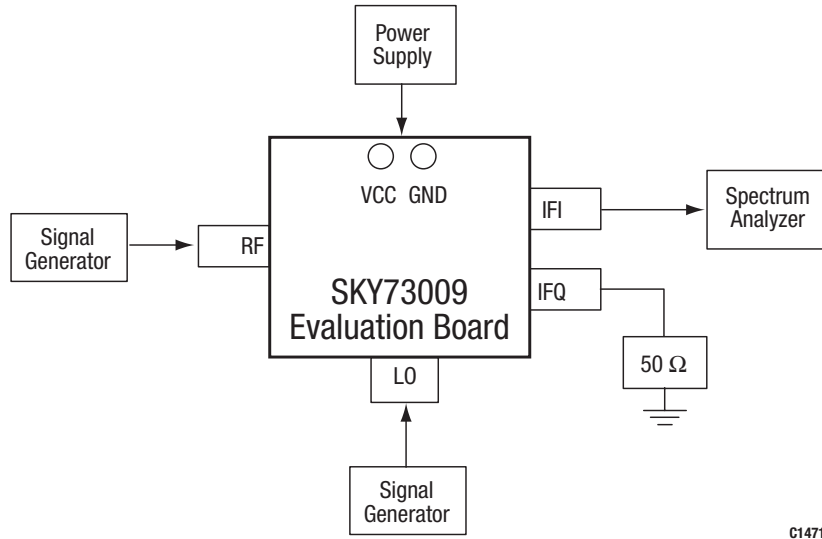

C1471

Figure 61. SKY73009 Evaluation Board Testing Configuration

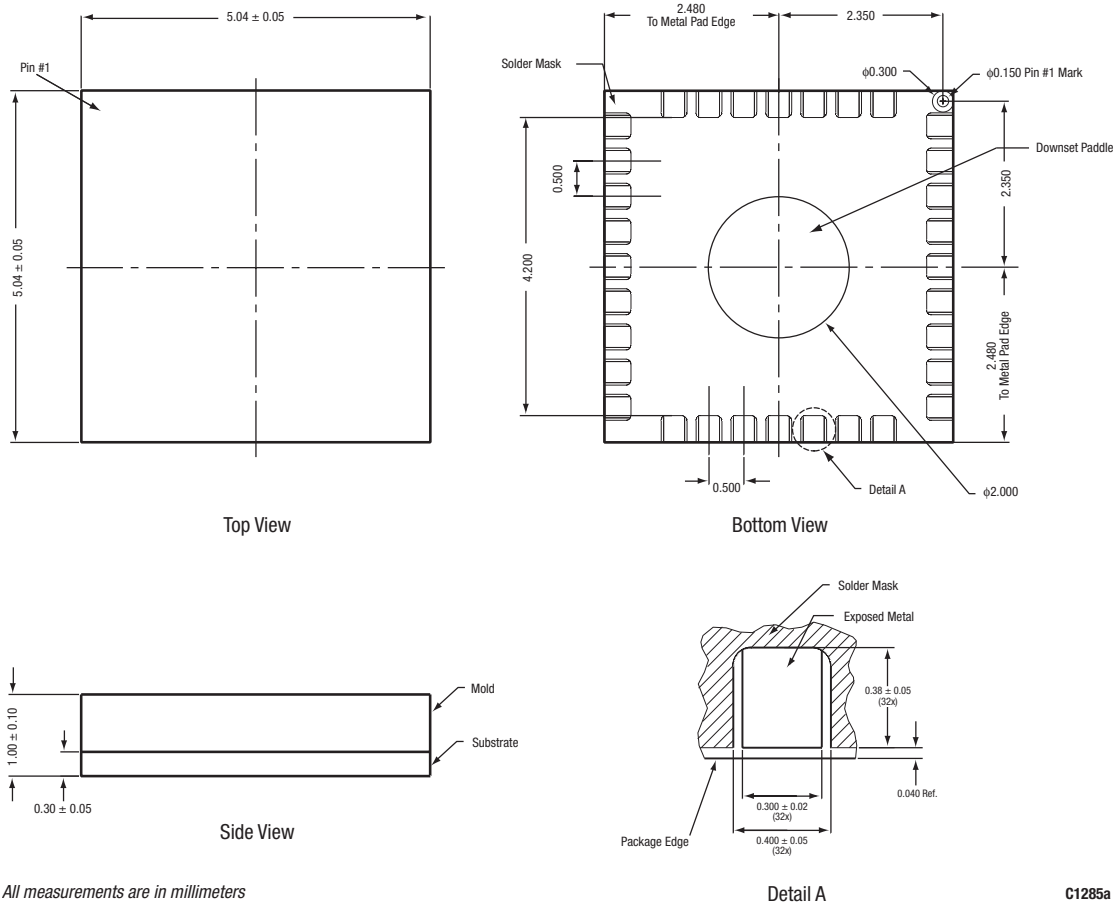

All measurements are in millimeters

C1285a

Figure 62. SKY73009 32-Pin RFLGA Package Dimensions

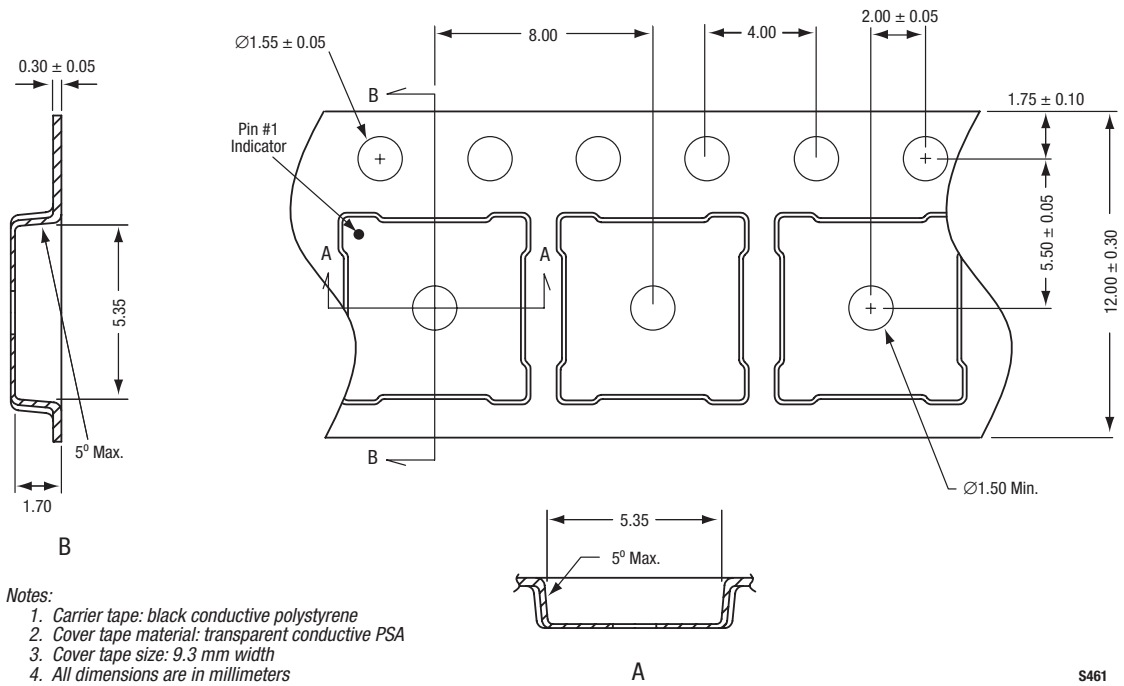

Figure 63. SKY73009 32-Pin RFLGA Tape and Reel Dimensions

Ordering Information

Model Name	Manufacturing Part Number	Evaluation Kit Part Number
SKY73009 400-3000 MHz Direct Quadrature Modulator	SKY73009-11	TW11-D982 (tuned for 800 to 1000 MHz) TW11-D992 (tuned for 1800 to 2000 MHz) TW12-D275 (custom frequency board)

Copyright © 2003, 2004, 2005, 2006, Skyworks Solutions, Inc. All Rights Reserved.

Information in this document is provided in connection with Skyworks Solutions, Inc. ("Skyworks") products or services. These materials, including the information contained herein, are provided by Skyworks as a service to its customers and may be used for informational purposes only by the customer. Skyworks assumes no responsibility for errors or omissions in these materials or the information contained herein. Skyworks may change its documentation, products, services, specifications or product descriptions at any time, without notice. Skyworks makes no commitment to update the materials or information and shall have no responsibility whatsoever for conflicts, incompatibilities, or other difficulties arising from any future changes.

No license, whether express, implied, by estoppel or otherwise, is granted to any intellectual property rights by this document. Skyworks assumes no liability for any materials, products or information provided hereunder, including the sale, distribution, reproduction or use of Skyworks products, information or materials, except as may be provided in Skyworks Terms and Conditions of Sale.

THE MATERIALS, PRODUCTS AND INFORMATION ARE PROVIDED "AS IS" WITHOUT WARRANTY OF ANY KIND, WHETHER EXPRESS, IMPLIED, STATUTORY, OR OTHERWISE, INCLUDING FITNESS FOR A PARTICULAR PURPOSE OR USE, MERCHANTABILITY, PERFORMANCE, QUALITY OR NON-INFRINGEMENT OF ANY INTELLECTUAL PROPERTY RIGHT; ALL SUCH WARRANTIES ARE HEREBY EXPRESSLY DISCLAIMED. SKYWORKS DOES NOT WARRANT THE ACCURACY OR COMPLETENESS OF THE INFORMATION, TEXT, GRAPHICS OR OTHER ITEMS CONTAINED WITHIN THESE MATERIALS. SKYWORKS SHALL NOT BE LIABLE FOR ANY DAMAGES, INCLUDING BUT NOT LIMITED TO ANY SPECIAL, INDIRECT, INCIDENTAL, STATUTORY, OR CONSEQUENTIAL DAMAGES, INCLUDING WITHOUT LIMITATION, LOST REVENUES OR LOST PROFITS THAT MAY RESULT FROM THE USE OF THE MATERIALS OR INFORMATION, WHETHER OR NOT THE RECIPIENT OF MATERIALS HAS BEEN ADVISED OF THE POSSIBILITY OF SUCH DAMAGE.

Skyworks products are not intended for use in medical, lifesaving or life-sustaining applications, or other equipment in which the failure of the Skyworks products could lead to personal injury, death, physical or environmental damage. Skyworks customers using or selling Skyworks products for use in such applications do so at their own risk and agree to fully indemnify Skyworks for any damages resulting from such improper use or sale.

Customers are responsible for their products and applications using Skyworks products, which may deviate from published specifications as a result of design defects, errors, or operation of products outside of published parameters or design specifications. Customers should include design and operating safeguards to minimize these and other risks. Skyworks assumes no liability for applications assistance, customer product design, or damage to any equipment resulting from the use of Skyworks products outside of stated published specifications or parameters.

Skyworks, the Skyworks symbol, and "Breakthrough Simplicity" are trademarks or registered trademarks of Skyworks Solutions, Inc., in the United States and other countries. Third-party brands and names are for identification purposes only, and are the property of their respective owners. Additional information, including relevant terms and conditions, posted at www.skyworksinc.com, are incorporated by reference.